

BEARING IN MIND: PRECISION BALL BEARING BASICS

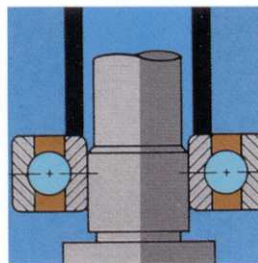

This booklet contains a series of informational articles on precision ball bearings published by The Barden Corporation. It is intended as a review of fundamental topics of importance to bearing specifiers and users. Additional detailed information is available from Barden; call (203) 744-2211, FAX (203) 744-3756, or write to The Barden Corporation, 200 Park Avenue, Danbury, CT 06813-2449.

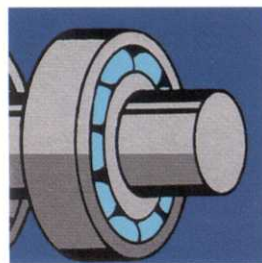
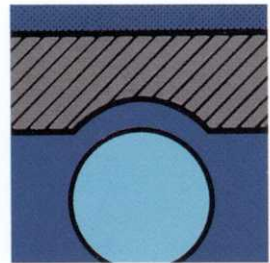
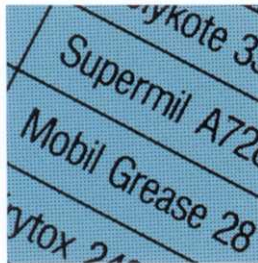
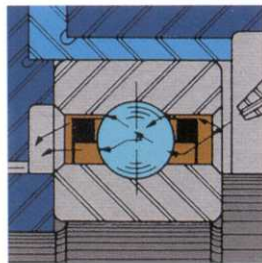
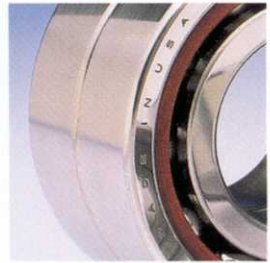
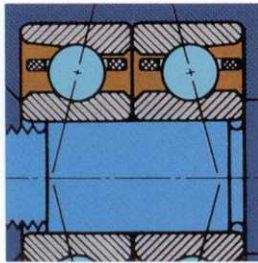
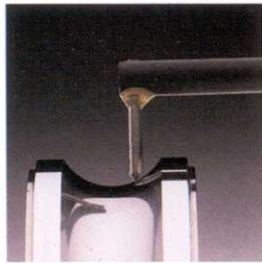

**CLOSURES –
AN OPEN AND
SHUT CASE**

Discussion of shields
and seals.

4

BEARING CAGES

Describes type, design,
material and uses.

5

**ABC's OF
ABEC CLASSES**

Review of ABEC
parameters and
classifications.

6

**ABOVE AND
BEYOND ABEC
TOLERANCES**

Where Barden Bearings
exceed ABEC standards.

7

**WHEN AND HOW
TO PRELOAD
BEARINGS**

Discussion of various
types of preload
mechanisms.

8

**DUPLEX
BEARINGS**

Use and installation
of pairs.

9

**OIL
LUBRICATION**

Basic methods and
types.

10

**GREASES FOR
PRECISION
BEARINGS**

Speedability,
temperatures, Barden
codes and other factors.

11

**RADIAL
INTERNAL
CLEARANCE**

Review of radial play
and Barden radial
play codes.

12

**SHAFT AND
HOUSING FITS**

Loose and tight
fitting practices.

13

**CAUTION:
BEARINGS –
HANDLE WITH
CARE**

Guidelines for han-
dling and installation.

14

**DEEP GROOVE
OR ANGULAR
CONTACT**

Review of
fundamental
characteristics.

15

CLOSURES — AN OPEN AND SHUT CASE

The two basic types of bearing closures are shields and seals, both of which may be ordered as integral components of deep groove bearings. (The angular contact bearing design is not easily adaptable to integral closures.)

All closures serve the same purposes with varying effectiveness. They exclude contamination, contain lubricants and protect the bearing from internal damage during handling.

Closures are attached to the outer ring. If they contact the inner ring, they are seals. If they clear the inner ring, they are shields.

Seals and shields used in Barden ABEC 7 bearings are designed so that the stringent precision tolerances are not affected by the closures. They are available in large precision spindle and turbine bearings as well as in Barden miniature and instrument bearings.

Most deep groove bearings are available with a closure on one or both sides. Occasionally, a bearing size and cage configuration will accommodate only one closure.

SELECTION OF CLOSURES

Determining the proper closure for an application involves a tradeoff, usually balancing sealing efficiency against speed capability and bearing torque.

Shields do not raise bearing torque or limit speeds, but they have low sealing efficiency. Seals rate high in bearing protection, but they impose varying restrictions on operating speed and can result in increased torque and temperature.

Another consideration in closure selection is air flow through the bearing, which is detrimental because it carries contamination into the bearing and dries out the lubricant. Seals should be used if air flow is present.

BARDEN DEVELOPMENTS IN EFFECTIVE CLOSURES

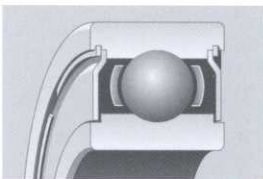

Shields are precision-stamped of stainless steel in a dished shape to provide rigidity, resistance to resonant vibration and maximum lubricant space within the bearing. Inner ring notches are provided where space permits, to present a difficult entry path for contaminants.

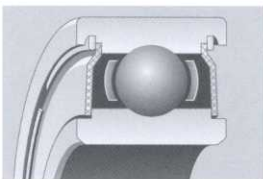

Flexeal™ is a Barden-developed seal with a layer of fiber bonded to a precision aluminum stamping. The fiber is prelubricated to produce extremely low friction at the ground sealing notch. This low friction allows Flexeal equipped bearings to operate at speeds up to 600,000 dN. Maximum temperature is 300°F continuously, 350°F intermittently.

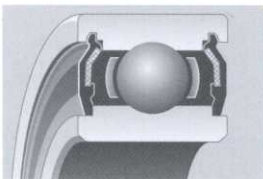

Barseal™ is a composite seal consisting of molded rubber with a metal stiffener. It offers optimum sealing and is designed to contact the inner ring intimately under all loading conditions. The inner ring seal riding surfaces are ground for better sealing, lower torque and longer life.

Maximum dN (bearing bore in mm X RPM) with Barseals is 180,000; temperature range is -30°F to 225°F.

*For more information or a set of **Bearing in Mind** articles, call (203) 744-2211, Ext. 468, or write to The Barden Corporation, 200 Park Ave., Danbury, CT 06810.*

BEARING CAGES



**BARDEN
PRECISION
BEARINGS**

Most bearing assemblies include a cage to maintain uniform ball spacing, reduce torque and lessen heat buildup. Barden deep groove and angular contact bearings are available with several different types of cages to suit a variety of applications.

FOR DEEP GROOVE BEARINGS

The principal cage designs for our deep groove bearings are snap-in types Q, TA, TMT and TB; symmetrical types P, W and T. Type W is a low torque cage developed by Barden, available in many miniature and instrument sizes. This two-piece ribbon cage is loosely clinched to prevent cage windup (a torque-increasing drawback of some cage designs) in sensitive low torque applications.

Ribbon cages P and W are used at moderate speeds and are particularly suited for bearings with grease lubrication and seals or shields. For higher speeds, Barden offers the one-piece phenolic snap-in type TA cage in smaller bearing sizes and the two-piece riveted phenolic, aluminum-reinforced T cage for larger sizes. The aluminum reinforcement, a Barden first, provides additional strength and permits use of this high-speed cage in most standard width sealed or shielded bearings.

FOR ANGULAR CONTACT BEARINGS

In Barden angular contact bearings, the standard cages, types B and H, are machined phenolic with highspeed capability. These cages are outer ring land-guided, which allows lubricant access to the most desired point – the inner ring ball contact area. Centrifugal force carries lubricant outward during operation to reach the other areas of need.

The H-type phenolic cage has a grooved inner surface to hold extra lubricant. From the grooves, lubricant can migrate to critical bearing contact surfaces. In separable type bearings, the B-type cage has stepped or conical pockets to hold the balls in place when the inner ring is removed.

For more information or a set of Bearing in Mind articles, call (203) 744-2211, Ext. 468, or write to The Barden Corporation, 200 Park Ave., Danbury, CT 06810.

CAGES FOR DEEP GROOVE BEARINGS			
Type		Use	Material
crown type, snap-in cage		general purpose	stainless steel AISI 410
2-piece ribbon cage, full clinch		general purpose	stainless steel AISI 430 AISI 305
W – 2-piece ribbon cage, loosely clinched		general purpose, low torque instruments	stainless steel AISI 430 AISI 305
TA – crown type, snap-in cage		high speed, general purpose	Phenolic
T – 2-piece riveted		high speed, general purpose	Phenolic Aluminum Reinforced
TMT – crown type, snap-in cage		general purpose	filled nylon 6/6
TB – crown type, snap-in cage		light load, no lubrication, in stainless steel bearing only, high and low temp., moderate speed	BarTemp
TQ – crown type, snap cage		high speed, quiet operation	Delrin*

* Reg. DuPont Trademark

CAGES FOR ANGULAR CONTACT BEARINGS			
Type		Use	Material
B [†] – 1-piece, for bearings with separable outer rings		high speed, general purpose	Phenolic
H [†] – 1-piece, for bearings with separable outer rings		high speed, general purpose	Phenolic

† Symbol for bearing type. No symbol is used in nomenclature for standard cage.

ABC'S OF ABEC CLASSES

Precision ball bearings are manufactured to tolerance standards set by the Annular Bearing Engineers Committee (ABEC) of the American Bearing Manufacturers Association (ABMA). These standards have been accepted by the American National Standards Institute (ANSI) and conform essentially with standards of the International Organization for Standardization (ISO).

ABEC PARAMETERS

ABEC standards define tolerances for several major bearing dimensions and characteristics, divided into mounting dimensions (bore, O.D. and width) and bearing geometry (see illustration). The geometric tolerances apply to both inner and outer rings.

It is important to realize that ABEC standards do not address many other factors which affect bearing performance and life, including:

- Materials
- Ball complement – number, size and precision
- Raceway curvature, roundness and finish
- Radial play or contact angle
- Cage design
- Lubricant

ABEC PRECISION CLASSES

General-purpose, spindle size ball bearings are manufactured to precision classes ABEC 1, ABEC 5, ABEC 7 and ABEC 9. The ascending numbers indicate stricter tolerances and additional requirements. All Barden spindle bearings meet ABEC 9.

Miniature and instrument bearings are produced in comparable classes, with added refinements designated by suffixes: ABEC 3, ABEC 5P, ABEC 7P, ABEC 9P, ABEC 5T and ABEC 7T. Barden bearings in this category are made to ABEC 7P or better. Barden torque tube and extra-thin series bearings meet ABEC 5T or 7T.

All bearing manufacturers can furnish ABMA tolerance data for ABEC classes. In addition, Barden can indicate those characteristics of Barden bearings which are consistently held to closer tolerances than ABEC standards.

For more information or a set of Bearing in Mind articles, call (203) 744-2211, Ext. 468, or write to The Barden Corporation, 200 Park Ave., Danbury, CT 06810.

ABEC CRITERIA FOR RINGS

(inner ring illustrated)

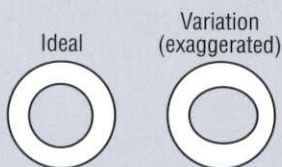

Bore Roundness

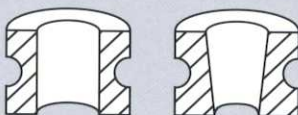

Bore Taper

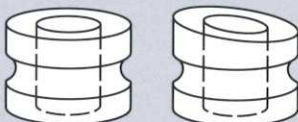

Width Variation



Bore Runout With Side

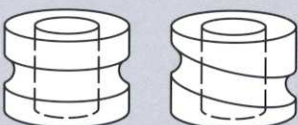

Race Runout With Side

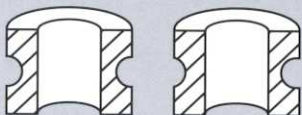

Radial Runout

ABOVE AND BEYOND ABEC TOLERANCES



ABEC tolerance classes are useful in bearing selection. By specifying ABEC 7, for example, the design engineer is able to pinpoint a standardized level of bearing precision.

However, ABEC classes are not all-inclusive in defining bearing precision. Bearing performance and life can be affected by factors other than ABEC-controlled characteristics.

FUNCTIONAL TESTING

ABEC tolerance classes contain no provisions for functional testing of an assembled bearing, yet it can be extremely important. Barden applies self-established standards to ensure that we deliver quiet, smooth-running bearings that will perform well in specific applications.

Bearing-generated vibration is checked by using either the Barden developed Smoothrator® or the Bendix Anderometer®.

Bearing running torque is measured by various instruments such as the Barden Torkintegrator. Starting torque can also be measured on special gages.

Nonrepetitive runout of a bearing – a function of race lobing, ball diameter variation and cleanliness – is gaged on proprietary Barden instruments.

BEARING DESIGN

ABEC classes do not address bearing design, yet the ball complement, shoulder heights, cage design and material quality can mean the difference between success and failure in bearing applications.

COMPONENT TOLERANCES

Rings. There are several aspects of inner and outer rings not covered by ABEC standards, including raceway roundness, cross race radius form and raceway finish. Barden has imposed its own criteria and uses several means to check roundness and cross race radius for compliance.

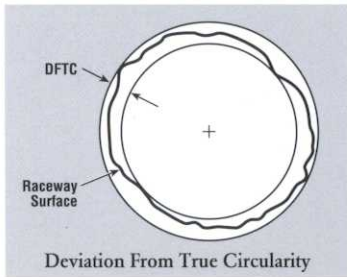

DFTC (deviation from true circularity) measurements are made and graphically depicted by concentric circles enclosing the low and high points of raceway deviation.

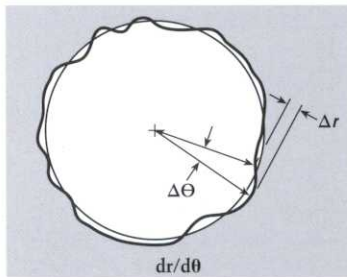

$dr/d\theta$ (change in radius with a change in circumferential location) measurements are made to define lobing or waviness that could generate noise and vibration in an operating bearing.

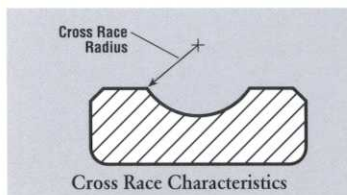

Cross race characteristics. Radius form, waviness and surface finish are closely monitored by Barden, using laser and computer technology. With equipment unique in the industry, cross race traces are made for comparison with Barden standards.

Balls. ABMA has generated grades of balls for bearings, but these are not specified in ABEC tolerance classes. Barden uses balls produced to its specifications by Winsted Precision Ball Company, a wholly owned division of The Barden Corporation.

*For more information or a set of **Bearing in Mind** articles, call (203) 744-2211, Ext. 468, or write to The Barden Corporation, 200 Park Ave., Danbury, CT 06810.*

WHEN AND HOW TO PRELOAD BEARINGS

Preloading is the removal of internal clearance in a bearing by applying a permanent thrust load to it. Preloading is used to:

- Eliminate radial and axial play.
- Increase system rigidity.
- Reduce nonrepetitive runout.
- Limit the difference in contact angle between inner and outer rings at very high speed.
- Prevent ball skidding under very high acceleration.

Bearings should be minimally preloaded to avoid excessive heat generation which reduces speed capability and bearing life.

There are three basic methods of preloading, involving springs, axial adjustments or duplex bearings.

SPRING PRELOADING

This is often the simplest method and should be considered first. Spring preloading provides a more constant preload because it is less sensitive to differential expansion and accommodates minor misalignment better.

Many types of springs may be used, among them coil springs and belleville, wave or finger spring washers. Usually the spring is applied to the nonrotating part of the bearing – typically the outer ring. This ring must have a slip fit in the housing.

AXIAL ADJUSTMENT

Threaded members, shims and spacers are typical means of providing fixed preloads through axial adjustment. This technique requires great care and accuracy to avoid excessive preloading, which might occur initially through overloading during setup or during operation due to thermal expansion. Precision lapped shims are usually preferable to threaded members, because helical threads can lead to misalignment.

DUPLEX BEARINGS

Duplex bearings are produced at the factory by relieving selected inner or outer ring faces of a matched pair of bearings. The amount of relief on each face is called the preload offset. When the bearings are clamped together, the offset faces meet, establishing a preload. Duplex bearings are usually speed-limited due to heat generated by this preload.

For more information or a set of *Bearing in Mind* articles, call (203) 744-2211, Ext. 468, or write to The Barden Corporation, 200 Park Ave., Danbury, CT 06810.

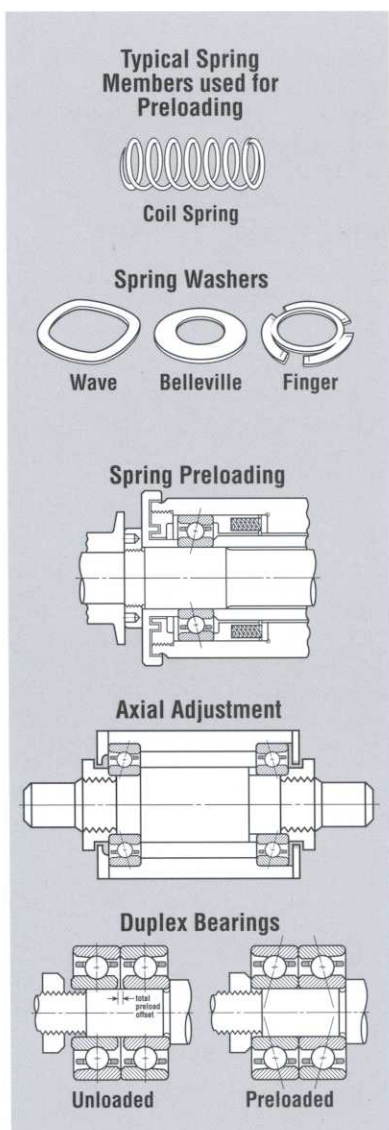

Duplex bearings are matched pairs of bearings with a built-in means of preloading. The inner or outer ring faces of these bearings have been selectively relieved a precise amount called the preload offset. When the bearings are clamped together during installation, the offset faces are brought into contact with each other, establishing a permanent preload in the bearing set.

Duplexing is used to greatly increase radial and axial rigidity. Duplex bearings can withstand bidirectional thrust loads (DB and DF mounting) or heavy unidirectional thrust loads (DT mounting).

DB MOUNTING (back-to-back)

This configuration is suited for most applications having good alignment of bearing housings and shafts. It is also preferable where high moment rigidity is required, and where the shaft runs warmer than the housing.

Inner ring abutting faces of DB duplex bearings are relieved. When they are mounted and the inner rings clamped together, the load lines (lines through points of ball contact) converge outside the bearings, resulting in increased moment rigidity.

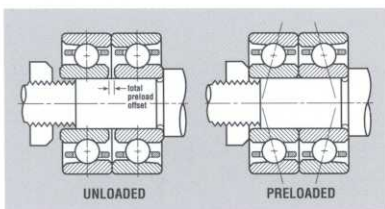

DF MOUNTING (face-to-face)

DF mounting is used in fewer applications, mainly where there is misalignment. Speedability is usually lower than for a DB pair.

Outer ring abutting faces of DF duplex bearings are relieved. When the bearings are mounted and the outer rings clamped together, the load lines converge toward the bore.

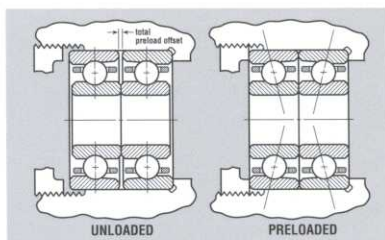

DT MOUNTING (tandem)

DT pairs offer greater capacity without increasing bearing size, through load sharing. They can counter heavy thrust loads from one direction, but they cannot take reversing loads as DB and DF pairs can.

Inner and outer rings of DT pairs have equalized offsets, creating parallel load lines. When mounted and preloaded by thrust forces, both bearings share the load equally.

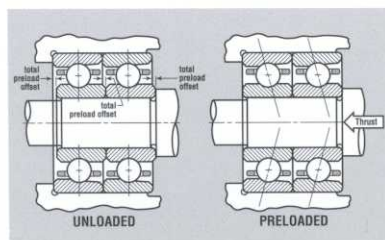

BARDEN DUPLEX BEARINGS

Most Barden angular contact duplex bearings are universally ground, for mounting either DB, DF or DT. They are available with light, medium and heavy preloads; values for each change with the bearing size.

For a given Barden duplex pair, bore and O.D. are matched within 0.0001", therefore, duplex sets should not be separated or intermixed. High points of eccentricity are marked on both inner and outer rings. The high points should be aligned during assembly (inner to inner, outer to outer) to get a smoother, cooler and more accurate running spindle.

Barden deep groove bearings are also available in duplex sets. They are not universally ground, but are furnished in specific DB, DF or DT configurations. When closures are needed, they can be installed on the outer sides of duplexed Barden deep groove bearings.

For more information or a set of *Bearing in Mind* articles, call (203) 744-2211, Ext. 468, or write to The Barden Corporation, 200 Park Ave., Danbury, CT 06810.

OIL LUBRICATION

In selecting the proper lubricant for a precision bearing, one consideration is oil vs. grease. Grease lubrication is simpler, but there are times when oil is better.

Instrument bearings with extremely low values of starting and running torque need only a minimal, one-time lubrication. Each bearing receives just a few milligrams of oil (a single drop or less).

In machine tool spindles and other high-speed applications, oil is continuously supplied and provides cooling as well as lubrication, so that the bearings can run faster. The maximum dN rating ($dN = \text{bearing bore in mm} \times \text{RPM}$) for greases is approximately 800,000, whereas oils can accommodate one million dN or higher.

OIL LUBRICATION SYSTEMS

An oil-lubricated bearing usually requires a systems approach. The most common types of lubrication systems are:

Bath. Oil is fed to the bearing from a built-in reservoir by wicking, dripping or submerging the bearing wholly or partially in oil.

Splash. From a built-in reservoir, oil is distributed by a high-speed rotating component partially submerged in oil.

Air/oil mist. Mixture of air and oil is sprayed into and through the bearing from an external source. Excellent system for lubricating and cooling bearings operating at very high speeds under light loads.

Jet. Oil is squirted into and through the bearing from an external source. Excellent where loads are heavy, speeds and temperatures are high. Efficiently applied flow of oil both lubricates and cools.

OIL TYPES

Oils used in bearings are of four general types, which are usually supplemented by additives to compensate for deficiencies or to provide special characteristics.

Petroleum oils. Classified as naphthenic or paraffinic, depending on the crude oil source. Excellent general-purpose oils at normal temperatures (-40 to 250°F). Additives are typically required to inhibit oxidation, foaming and polymerization; and to improve viscosity index.

Diesters. Synthetic oils developed for applications requiring low torque at subzero starting temperatures and higher operating temperatures.

Silicones. Synthetic compounds with a relatively constant viscosity over their temperature range. Used for very cold starting and low torque applications. Generally undesirable for high loads and speeds.

Fluorocarbons. Synthetic oils for corrosive, reactive or high temperature (up to 550°F) environments. Nonsoluble in most solvents. Excellent oxidative stability, low volatility. They provide poor protection against bearing corrosion.

OIL PROPERTIES

Viscosity. Resistance to flow.

Viscosity index. Rating of viscosity changes at varying temperatures.

Lubricity. Rating of sliding friction at boundary conditions of lubrication.

Pour point. Lowest temperature at which oil will pour (flow).

Oxidation resistance. Rating of an oil's resistance to oxidation caused by high temperatures, presence of oxygen and catalytic metals (especially copper).

Corrosion resistance. Rating of an oil's ability to protect bearing from corrosion.

Flash point. Temperature at which an oil gives off flammable vapors.

Fire point. Temperature at which an oil burns if ignited.

*For more information or a set of **Bearing in Mind** articles, call (203) 744-2211, Ext. 468, or write to The Barden Corporation, 200 Park Ave., Danbury, CT 06810.*

GREASES FOR PRECISION BEARINGS



**BARDEN
PRECISION
BEARINGS**

Grease is a semisolid lubricant consisting of an oil and a thickening agent. Its primary advantage over oil is that bearings can be prelubricated with grease, eliminating the need for an external lubrication system. This grease is often adequate for the life of the application. On the other hand, grease can be expected to increase the initial bearing torque and may exhibit a slightly higher running torque. There are dozens of bearing greases in current use; their characteristics vary widely to meet different application requirements.

SPEEDABILITY

Speedability is expressed as a dN value, with dN being:

$$dN = \text{bearing bore in mm multiplied by RPM}$$

The greatest dN that greases can normally tolerate for continuous operation is approximately 800,000. This value is influenced by factors such as type of grease, loads and temperatures.

TEMPERATURE

Most greases are limited to a maximum temperature of 300°F, some only to 250° or 200°. Specially formulated high temperature greases can operate at 450°, or 500°F for short periods. For all greases, life is severely penalized by operation near their temperature limits.

CONSISTENCY (Stiffness)

Stiffer, channeling type greases are required for high-speed applications to minimize heat generation due to churning. Also, stiffer consistency greases are beneficial for applications with outer ring rotation where centrifugal force tends to sling grease out of the bearing, and those vertical axis applications (bearings installed horizontally) where gravity pulls grease away from its intended position.

COMBINATIONS OF FACTORS

To maintain a normal grease life expectancy, adverse operating conditions must not be present in combination. Thus, at temperatures near the limits shown in the table, speed and load should be low. Or, at maximum speeds, temperature and load should be low.

In certain applications, such combinations are unavoidable and tradeoffs are necessary. For example, if speed and temperature are both high, loads must be low and life will be short.

For more information or a set of *Bearing in Mind* articles, call (203) 744-2211, Ext. 468, or write to The Barden Corporation, 200 Park Ave., Danbury, CT 06810.

Typical Greases Used By Barden									
Barden Code	Grease	Maximum dN	Operating Temperature Range, °F						
			-100	0	100	200	300	400	500
G-14L	Molykote 33 Light	200,000							
G-32	Supermil A72832	400,000							
G-33	Mobil Grease 28	400,000							
G-36	Krytox 240AC	400,000							
G-18	Rheotemp 500	500,000							
G-6	Andok C	650,000							
G-28	Andok B	600,000							
G-29	Andok 260	600,000							
G-42	Rheolube 350-SBG-2	650,000							

NOTES: Characteristics listed are based on Barden experience and are intended as general guidelines for reference only. Consult Barden Product Engineering Department for specific usage recommendations.

RADIAL INTERNAL CLEARANCE

Radial internal clearance in a ball bearing assembly is the total maximum possible movement, perpendicular to the bearing axis, of the inner ring in relation to the outer ring. It is commonly referred to as radial play.

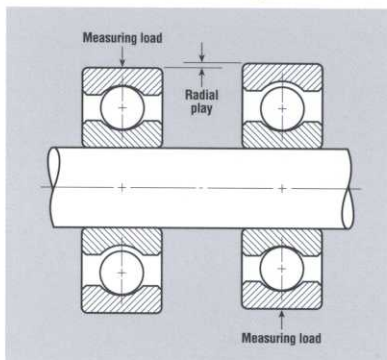

Radial internal clearance is measured under a light reversing radial load and corrected to zero load, to establish radial play values.

Although often overlooked by designers, radial play is one of the most important basic bearing specifications. The presence and magnitude of radial play are vital factors in bearing performance.

Without sufficient radial play, interference fits (press fits) and normal expansion of components cannot be accom-

modated, causing binding and early failure. High operating speeds create heat through friction and require greater than usual radial play.

Higher values of radial play are also beneficial where thrust loads predominate, to increase load capacity, life and axial rigidity. On the other hand, low values of radial play are better suited for predominantly radial support.

Deep groove bearings are available from Barden in a range of radial play groups. Each group is expressed as a Radial Play Code, representing limits to the range of radial internal clearance.

BARDEN RADIAL PLAY CODES

Radial play ranges vary with ball size and bearing size; the table below shows only one of several radial play groupings for Barden products. Such ranges have nothing to do with ABEC tolerances or precision classes, hence a high value of radial play does not imply lower quality or less precision.

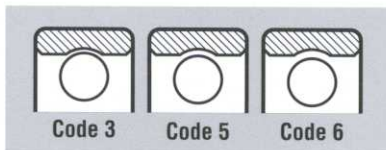

Specifying a radial play code must take into account the installation practice. If a bearing is press-fit onto a shaft or into a housing, its radial internal clearance is reduced by approximately

Typical Barden Radial Play Grouping			
Range	Barden Code Code	ABMA Designation	Radial Play
Tight	3	0	.0002" to .0004"
Normal	5	3	.0005" to .0008"
Loose	6	4	.0008" to .0011"

80% of the interference fit. Thus, an interference fit of .00025" would cause a .0002" decrease in internal clearance.

Angular contact bearings make use of radial play, combined with thrust loading, to develop their primary characteristic – an angular line of contact between the balls and both races.

Standard angular contact bearings are manufactured to nominal contact angles, rather than radial play codes. In Barden spindle size bearings, the nominal contact angle is either 15° or 25°. As with radial play codes, the smaller angle delivers better radial capacity and rigidity, the larger angle is better for axial rigidity.

For more information or a set of *Bearing in Mind* articles, call (203) 744-2211, Ext. 468, or write to The Barden Corporation, 200 Park Ave., Danbury, CT 06810.

SHAFT AND HOUSING FITS



Shaft and housing mounting details are important factors in successful bearing applications. The tables below provide general guidelines for fits, but other application conditions or needs often make it necessary to vary the fits shown.

Tighter fits on shafts and in housings are advisable where there is:

- A need to avoid mass center shift.
- Heavy radial loading.
- Vibration that could cause fretting and wear
- A need for heat transfer.

Looser fitting practices are advisable when:

- There are axial clamping forces.
- Ease of assembly is important.
- There must be axial movement to accommodate spring loading or thermal movements.

FITTING NOTES:

1. Before establishing tight interference fits, consider their effects on radial internal clearance and bearing preloads (if present). Also realize that distortions in shaft or housing geometry may be transferred to the bearings through tight fits.
2. Keep in mind that mounting fits may be substantially altered at operating temperatures due to differential expansion of components.
3. Diameter and squareness tolerances for shaft and housing mounting surfaces and shoulders should be similar to those for the bearing bore and O.D. The surface finish and hardness of mating components should be suitable for prolonged use, to avoid deterioration of fits during operation.
4. Where a more precise fit is desired, bearings can be obtained that are calibrated into narrower bore and O.D. tolerance groups. These can be matched to similarly calibrated shafts and housings to cut the fit tolerance range by 50% or more.

For more information or a set of *Bearing in Mind* articles, call (203) 744-2211, Ext. 468, or write to The Barden Corporation, 200 Park Ave., Danbury, CT 06810.

Shaft Fits				
Inner Ring Condition	Fit Class	Nominal Bore Diameter, mm		
		7 – 30	31 – 80	81 – 180
Rotating, not clamped	N	+0.000, – .0003"	+0.000, – .0004"	+0.000, – .0006"
Rotating, clamped	T	+0.0015, – .00015"	+0.002, – .0002"	+0.003, – .0003"
Non-rotating, fixed	T	+0.0015, – .00015"	+0.002, – .0002"	+0.003, – .0003"
Non-rotating, movable	C	+0.003, – .0000"	+0.004, – .0000"	+0.006, – .0000"

Housing Fits				
Outer Ring Condition	Fit Class	Nominal Outside Diameter, mm		
		18 – 80	81 – 120	121 – 250
Rotating, not clamped	N	+0.000, – .0004"	+0.000, – .0006"	+0.000, – .0008"
Rotating, clamped	T	+0.002, – .0002"	+0.003, – .0003"	+0.004, – .0004"
Non-rotating, fixed	T	+0.002, – .0002"	+0.003, – .0003"	+0.004, – .0004"
Non-rotating, movable	C	+0.004, – .0000"	+0.006, – .0000"	+0.008, – .0000"

NOTES: C=loose fit, T=line-to-line fit, N=tight fit. (+) indicates clearance, (-) indicates interference.

CAUTION: BEARINGS — HANDLE WITH CARE

The first rule for handling bearings is keep them clean. Consider every kind of foreign material — dust, moisture, fingerprints, solvents, lint, dirty grease — to be abrasive, corrosive or otherwise destructive.

All work spaces, tools, transport equipment, fixtures and mating parts should be clean also.

The second rule is handle with care. Bearings should remain in their original packaging, unopened, until ready for installation. All Barden boxes carry nomenclature for the bearings inside, so there is no need to refer to the bearing itself for identification. And, since the full bearing number appears only on Barden packaging, it should always stay with the bearing.

Do not wash new bearings. Barden takes great care in cleaning its bearings and properly prelubricating them before packaging.

All Barden bearings are demagnetized before shipment. If there is any indication that they have become magnetized, which would attract metallic contaminants, pass the wrapped bearings through a demagnetizer.

HANDLING GUIDELINES

1. Clean the work area; keep it clean.
2. Use clean, burr-free tools that are designed for the job. They should not be painted or chrome-plated.
3. Handle bearings with clean gloves or clean dry hands. Use tweezers for miniature bearings.
4. Remove bearings from original packaging immediately before using them.
5. Protect unwrapped bearings by keeping them covered at all times.
6. Assemble only clean, burr-free parts. Clean the interior of housings.
7. Use heat assembly (differential expansion) or an arbor press for interference fits. Never use a hammer or sharp blows.
8. Be sure bearing rings are started evenly on shafts or in housings, to prevent cocking and distortion.
9. Apply force only to the ring being press-fitted. Never strike the outer ring, for example, to force the inner ring onto a shaft, or brinelling could result and cause high torque or noisy operation.
10. Use bearing-quality lubricants; keep them clean during application and covered between uses.
11. When removing bearings, clean all surrounding surfaces first. Isolate used bearings and inspect them carefully before reuse.

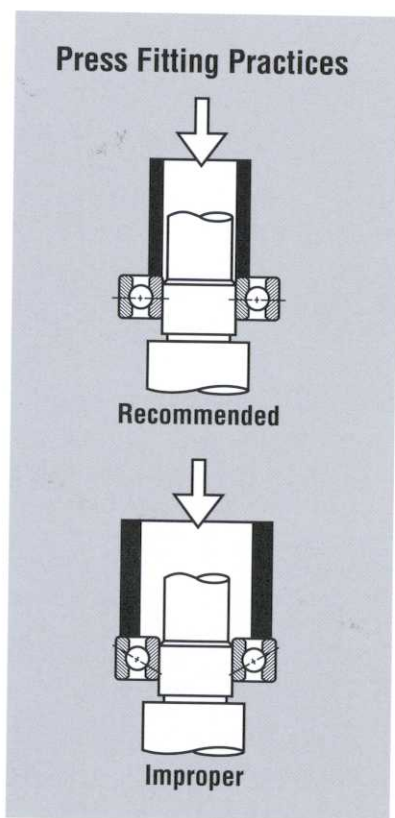

These common sense rules will help protect your investment in precision bearings and the even greater value of the rotating components they serve.

For more information or a set of *Bearing in Mind* articles, call (203) 744-2211, Ext. 468, or write to The Barden Corporation, 200 Park Ave., Danbury, CT 06810.

DEEP GROOVE OR ANGULAR CONTACT

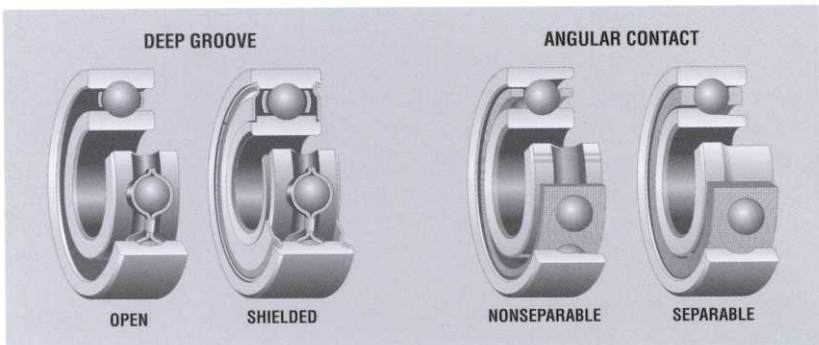

Design selections between deep groove and angular contact precision bearings depend primarily upon application characteristics such as magnitude and direction of loading, operating speed and conditions, lubrication, and requirements for accuracy and rigidity.

DEEP GROOVE

Deep groove ball bearings have full shoulders on both sides of the raceways of the inner and outer rings. They can accept radial loads, thrust loads in either direction, or a combination of loads.

The full shoulders and the cages used in deep groove bearings make them suitable for the addition of closures (seals or shields) to exclude contaminants and/or retain lubricants. Besides single deep groove bearings with closures, Barden also offers duplex pairs with seals or shields on the outboard faces.

Deep groove bearings are available in many sizes, with a variety of cage types – usually two-piece ribbon or one-piece snap-in cages. Their versatility makes deep groove bearings the most widely used type.

ANGULAR CONTACT

Angular contact bearings have one ring shoulder partially or totally removed. This allows a larger ball complement than found in comparable deep groove bearings, hence a greater load capacity.

Speed capability is also greater. The angular contact bearing design accepts one-piece cages and a wide variety of cage materials and designs. Thus, cages can be selected specifically for high speeds.

Standard Barden angular contact bearings have a nominal contact angle (angle between the ball-races contact line and a plane through the ball centers) of either 15° or 25°. Barden ball screw support bearings have a contact angle of 65°; the higher contact angle offers greater axial rigidity.

Angular contact bearings support thrust loads or combinations of radial and thrust loading. They cannot accept radial loads only – a thrust load of sufficient magnitude must be present. An individual angular contact bearing can be thrust-loaded in only one direction; this load may be in the form of a working load or a preload. Angular contact bearings are most commonly used in preloaded duplex sets, either back-to-back (DB) or face-to-face (DF) so they can support thrust loads in both directions.

Separable and nonseparable types are available within the category of angular contact bearings. In a separable bearing (Barden B type), the cage holds the balls in place so that the outer ring assembly (with cage and balls) can be separated from the inner ring.

Separable bearings are useful where bearings must be installed in blind holes or where press fits are required, both on the shaft and in the housing. The separable feature also permits dynamic balancing of a rotating component with inner ring in place, apart from the outer ring and housing.

*For more information or a set of **Bearing in Mind** articles, call (203) 744-2211, Ext. 468, or write to The Barden Corporation, 200 Park Ave., Danbury, CT 06810.*

Technical Literature Available From Barden

Barden product engineering catalogs and technical bulletins are available upon request. They include one-page Precision Bulletin data sheets up to the full-line C-20 catalog. Each offers

additional information on specific products or areas of interest.

Contact your authorized Barden distributor or call or write Barden direct.

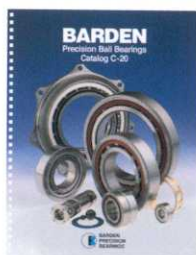

C-20
Precision Ball
Bearing Catalog
140 pages



C-8
Condensed
Precision Ball
Bearing Catalog
28 pages



Cages
Selection of Cage
Designs and Materials
for Ball Bearings
8 pages



Closures
Seal and Shield
Options for Ball
Bearings
4 pages

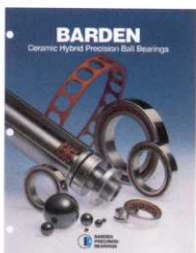

Ceramic Hybrids
Characteristics and
Performance Benefits
of Ceramic Hybrid
Bearings
4 pages

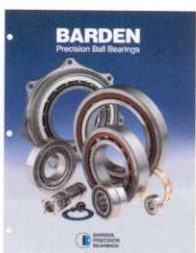

Barden
Review of Corporate
Capabilities
24 pages



**Handling and
Mounting**
Recommended
Handling and
Installation Practices
12 pages



**Bearing Failure:
Causes and Cures**
Identifying and
Correcting 12 Causes
of Bearing Failure
16 pages

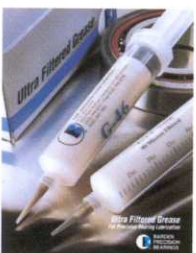

Ultra Filtered Grease
Specifications for
Barden Ultra Filtered
Grease Kits
2 pages

Precision Bulletin Series

- | | | |
|---|--|---|
| 1 Ceramics For Use in Ball Bearings | 6A Roundness | 13 Manufacturing High Precision Balls |
| 3 Coatings for Balls & Bearing Surfaces | 6B Curvature Measurement | 15 Vibration Analysis |
| 4 Ball Bearing Speedability | 7 ZSB Spindle Bearings | 16 Calibration |
| 5A Precision Bearing Lubrication | 9 Quiet Bearing Analyzer | 17 Effects of High Speed on Ball Bearings |
| 5B Greases for Precision Bearings | 10 Patented "H" Cage | |
| 5C Oil Lubrication | 11 Preloading Bearings | |
| | 12 Non-Destructive Testing of Bearings | |



THE BARDEN CORPORATION

200 Park Avenue, P.O. Box 2449, Danbury, CT 06813-2449
Phone: (203) 744-2211 • (800) 243-1060 • Fax: (203) 744-3756
Internet: www.bardenbearings.com