

Pillow Blocks and Bearing Inserts

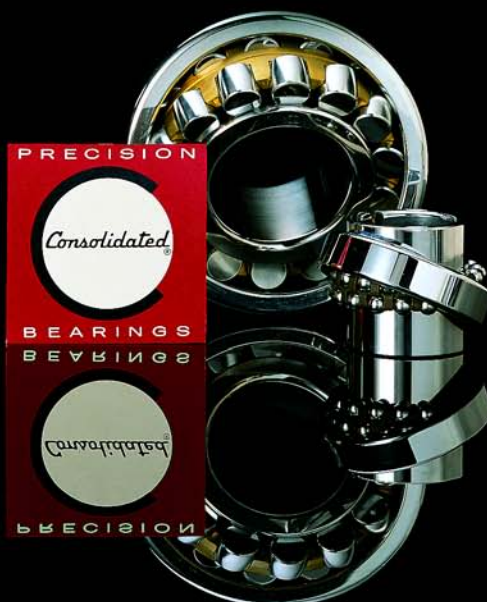

Product Reference & Interchange Catalog

CATALOG
2008



CONSOLIDATED BEARINGS COMPANY

Ten Wing Drive, Cedar Knolls, New Jersey 07927-1099

Tel: (973) 539-8300

Toll Free: 1-877-CON-BRG4

Fax: (973) 539-5902

(266-2744)

E-mail: sales@consbrgs.com Web Site: www.consbrgs.com

The contents of this catalog are the copyright of the publisher and may not be reproduced (including extracts) unless permission is granted in writing by Consolidated Bearings Company, Cedar Knolls, New Jersey. Every care has been taken to ensure the accuracy of the data contained in this catalog. No liability can be accepted for any errors, omissions or manufacturing design changes.

Price per copy - \$75.00

© Copyright 2008, Consolidated Bearings Co.



About the Company...

Consolidated Bearings Company, founded in 1932 by William F. Meerwarth, was originally established as a bearing rebuilder and manufacturer. In 1934 **Consolidated** obtained the exclusive contract to represent the SRO Ball Bearing Company of Zürich, Switzerland for sales of its products in the United States.

During World War II, when importing from Europe became non-existent, **Consolidated** concentrated its efforts in its Bearing Rebuilding Division. This Division added many valuable contributions to the War Effort in repairing and rebuilding worn bearings on an emergency basis. For their efforts, **Consolidated** earned the Army/Navy "E" Award.

Soon after the war, **Consolidated** reactivated its Import Division by representing several major European bearing manufacturers. Selling exclusively to Bearing Distributors and OEM Accounts, **Consolidated** established a network of sales offices and district warehouses throughout the United States to provide prompt and efficient service to all its customers.

In 1969, **Consolidated** built and moved to its present location in Cedar Knolls, New Jersey, a suburb West of New York City. Since then, **Consolidated** has twice increased the size of its facilities to keep up with its expanding product line. The most recent enlargement added another 125,000 square feet of warehouse space.

Consolidated is constantly looking at new products and new technologies to meet the future needs of its customers. The goal at **Consolidated** is to provide its customers with the most reliable service possible.

Abbreviations / Brands - Manufacturers

The following is a list of abbreviation/brands we have used in this catalog to identify the manufacturers and their respective country of origin.

BRAND	MANUFACTURER
ADR	Les Applications du Roulement - Div. of SKF Europe - France
AETNA	Aetna Bearing Co. - U.S.A.
AMERICAN	American Roller Bearing Co. - U.S.A.
ANDREWS	Andrews Bearing Corp. – Subs. of MPB Corp. – U.S.A.
AURORA	Aurora Bearing Co. – U.S.A.
BAL	Emil Baltzer - Germany
4 BARDEN	The Barden Corp. - Div. of Industrierwerk Schaeffler-Germany & USA.
BCA	BCA Bearing Div. - Federal Mogul - U.S.A.
BERLISS	Berliss Bearing Co. - U.S.A.
BOWER	Bower Bearing Div. - Federal Mogul - U.S.A.
CFW	Carl Freudenberg - Germany
CORLETT-TURNER	Corlett-Turner Co. - U.S.A.
ELGES	Helmut Elges GmbH - Germany
3 FAF	Fafnir Bearing - Div. of The Torrington Co. - U.S.A.- Subsidiary of Timken Bearing Co.
4 FAG	FAG Kugelfischer Georg Schafer & Co. - Germany and U.S.A. Subs. of Industrierwerk Schaeffler-Germany & USA.
FBC	Fafnir Bearing Co. Ltd. - England
FED/Schatz	Schatz Federal Bearing Co. Inc. - U.S.A.
GOETZE	Goetzewerka - Germany
HEIM	Heim Bearings Div. – Roller Bearing Co. of America – U.S.A.
1 HOFF	Hoffmann Manufacturing Co. - U.S.A. - England
HYATT	New Departure Hyatt - Hyatt Bearings Div. - U.S.A.
INA	Industrierwerk Schaeffler - Germany & U.S.A.
ISC	Ishii Steel Ball Co. Ltd. – Div. of Genbearco International Corp. - Japan
KACO	Kupfer-Asbest Co. - Germany
KAYDON	Kaydon Corp. - U.S.A.
McGILL	McGill Manufacturing Co. - U.S.A.
MRC	MRC Bearings - Div. of SKF Industries - U.S.A.
NACHI	Nachi-Fujikoshi Corp. - Japan
NADELLA	Nadella Societe Anoyma - France
ND	New Departure Hyatt - U.S.A.
2 NH	Norma Hoffmann Bearing Corporation - U.S.A.
NICE	Nice Ball Bearing Co. - Div. SKF Industries - U.S.A.
NMB	Nippon Miniature Bearing Co. Ltd. – Japan
NSK	NSK Bearing Corp. - Japan
NTN	NTN-Toyo Bearing Co. Ltd. - Japan
RBC	Roller Bearing Co. of America - U.S.A.
RHP	Ransome Hoffmann Pollard Ltd. - England
1 R&M	Ransome & Marles Bearing Co. Ltd - England
RIV	RIV - SKF - Italy
RMB	Landis & Gyr, Inc. - U.S.A.
ROLLWAY	Rollway Bearing Div. - Lipe-Rollway Corp. - U.S.A.
SEALMASTER	Sealmaster Bearing Div. - Emerson Electric - U.S.A.
SKF	SKF Industries - U.S.A, Sweden, England, Germany, France
SMITH	Smith Bearing Co. - U.S.A.
SNR	Societe Nouvelle de Roulements - France
SPHERCO	Spherco Bearing Div. – Emerson Electric – U.S.A.
2 SRO	J. Schmid-Roost Ltd. - Switzerland
STAR	Deutsche Star Kugelhalter GmbH - Germany
STEYR	Steyr-Walzlager GmbH - Subs. of SKF Industries - Austria
THOMSON	Thomson Industries Inc. - U.S.A.
TORRINGTON	The Torrington Company - U.S.A.- Subsidiary of Timken Bearing Co.

¹ These manufacturers have been reorganized to form RHP - Ransome Hoffmann Pollard Ltd.

² These manufacturers have been purchased by FAG. Therefore, these brands are no longer in use.

³ These manufacturers have been reorganized to form a subsidiary of Timken Bearing Co

⁴ These manufacturers have been reorganized to form a division of Industrierwerk Schaeffler-Germany & USA.

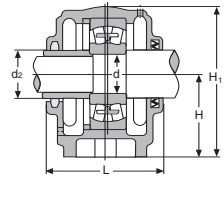
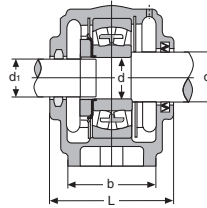
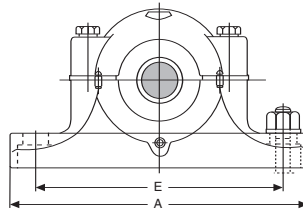

New Design

Old Design

PILLOW BLOCKS - HOUSING ONLY

Consolidated Housing No.	Dimensions (Metric)									Housing Only Approx. Wgt. lbs.	Suitable for Bearings	Stabilizing Rings Req'd No.	QTY	Interchange FAG SKF STEYR
	d	d1	d2	H	H1	E	A	b	L					
SN-205	25	20	30	40	75	130	165	46	67	2.870	6205, 1205, 20205	FR 52/5	2	SN 205
SN-206	30	25	35	50	90	150	185	52	77	3.970	6206, 1206, 20206	FR 62/7	2	SN 206
SN-207	35	30	45	50	95	150	185	52	82	4.630	6207, 1207, 20207	FR 72/8	2	SN 207
SN-208	40	35	50	60	110	170	205	60	85	6.620	6208, 1208, 20208	FR 80/8	2	SN 208
SN-209	45	40	55	60	110	170	205	60	85	6.170	6209, 1209, 20209	FR 85/6	2	SN 209
SN-210	50	45	60	60	115	170	205	60	90	6.840	6210, 1210, 20210	FR 90/7	2	SN 210
SN-211	55	50	65	70	130	210	255	70	95	9.480	6211, 1211, 20211	FR 100/6	2	SN 211
SN-212	60	55	70	70	135	210	255	70	105	11.000	6212, 1212, 20212	FR 110/8	2	SN 212
SN-213	65	60	75	80	150	230	275	80	110	13.900	6213, 1213, 20213	FR 120/10	2	SN 213
SN-214	70	-	80	80	155	230	275	80	115	14.300	6214, 1214, 20214	FR 125/10	2	SN 214
SN-215	75	65	85	80	155	230	280	80	115	15.400	6215, 1215, 20215	FR 130/8	2	SN 215
SN-216	80	70	90	95	175	260	315	90	120	20.500	6216, 1216, 20216	FR 140/9	2	SN 216
SN-217	85	75	95	95	185	260	320	90	125	21.600	6217, 1217, 20217	FR 150/9	2	SN 217
SN-218	90	80	100	100	195	290	345	100	145	27.100	6218, 1218, 20218	FR 160/16	2	SN 218
SN-219	95	-	110	112	210	290	345	100	145	29.500	6219, 1219, 20219	FR 170/10	2	SN 219
SN-220	100	90	115	112	215	320	380	110	160	36.400	6220, 1220, 20220	FR 180/18	2	SN 220
SN-222	110	100	125	125	240	350	410	120	175	42.600	6222, 1222, 20222	FR 200/21	2	SN 222
SN-224	120	110	135	140	270	350	410	120	185	54.200	6224, 20224	FR 215/23	2	SN 224
SN-226	130	115	145	150	290	380	445	130	190	63.900	6226, 20226	FR 230/25	2	SN 226
SN-228	140	125	155	150	305	420	500	150	205	81.570	6228, 20228	FR 250/28	2	SN 228
SN-230	150	135	165	160	325	450	530	160	220	99.210	6230, 20230	FR 270/30.5	2	SN 230
SN-232	160	140	175	170	345	470	550	160	235	116.850	6232, 20232	FR 290/33	2	SN 232
SN-205	25	20	30	40	75	130	165	46	67	2.870	2205, 22205	FR 52/7	1	SN 205
SN-206	30	25	35	50	90	150	185	52	77	3.970	2206, 22206	FR 62/10	1	SN 206
SN-207	35	30	45	50	95	150	185	52	82	4.630	2207, 22207	FR 72/10	1	SN 207
SN-208	40	35	50	60	110	170	205	60	85	6.620	2208, 22208	FR 80/10	1	SN 208
SN-209	45	40	55	60	110	170	205	60	85	6.170	2209, 22209	FR 85/8	1	SN 209
SN-210	50	45	60	60	115	170	205	60	90	6.840	2210, 22210	FR 90/10	1	SN 210
SN-211	55	50	65	70	130	210	255	70	95	9.480	2211, 22211	FR 100/8	1	SN 211
SN-212	60	55	70	70	135	210	255	70	105	11.000	2212, 22212	FR 110/10	1	SN 212
SN-213	65	60	75	80	150	230	275	80	110	13.900	2213, 22213	FR 120/12	1	SN 213
SN-214	70	-	80	80	155	230	275	80	115	14.300	2214, 22214	FR 125/13	1	SN 214
SN-215	75	65	85	80	155	230	280	80	115	15.400	2215, 22215	FR 130/10	1	SN 215
SN-216	80	70	90	95	175	260	315	90	120	20.500	2216, 22216	FR 140/10	1	SN 216
SN-217	85	75	95	95	185	260	320	90	125	21.600	2217, 22217	FR 150/10	1	SN 217
SN-218	90	80	100	100	195	290	345	100	145	27.100	2218, 22218	FR 160/11	2	SN 218
SN-219	95	-	110	112	210	290	345	100	145	29.500	2219, 22219	FR 160/10	1	SN 219
SN-220	100	90	115	112	215	320	380	110	160	36.400	2220, 22220	FR 170/10	1	SN 219
SN-222	110	100	125	125	240	350	410	120	175	42.600	2222, 22222	FR 180/12	2	SN 220
SN-224	120	110	135	140	270	350	410	120	185	54.200	23222	FR 180/10	1	SN 220
SN-226	130	115	145	150	290	380	445	130	190	63.900	22224	FR 200/14	2	SN 222
SN-228	140	125	155	150	305	420	500	150	205	81.570	23222	FR 200/10	1	SN 222
SN-230	150	135	165	160	325	450	530	160	220	99.210	23224	FR 215/14	2	SN 224
SN-232	160	140	175	170	345	470	550	160	235	116.850	23226	FR 215/10	1	SN 224
											22226	FR 230/13	2	SN 226
											23226	FR 230/10	1	SN 226
											22228	FR 250/15	2	SN 228
											23228	FR 250/10	1	SN 228
											22230	FR 270/16.5	2	SN 230
											23230	FR 270/10	1	SN 230
											22232	FR 290/17	2	SN 232
											23232	FR 290/10	1	SN 232

NOTE:

- 1.) The above are cast iron split housings and are equipped with felt seals.
- 2.) Felt seals can be substituted with SN-.. TA rubber seals. These seals are not interchangeable with housings from other manufacturers. Consult factory for availability.
- 3.) The above series has two bolt bases and two bolt caps.

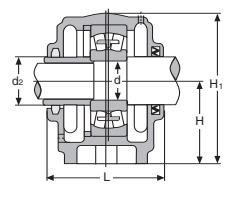
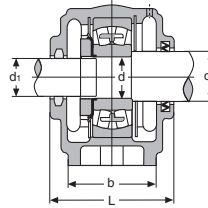
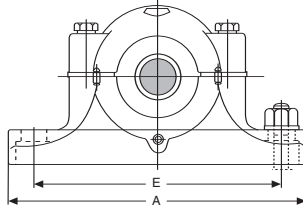

New Design

Old Design

PILLOW BLOCKS - HOUSING ONLY

Consolidated Housing No.	Dimensions (Metric)									Housing Only Approx. Wgt. lbs.	Suitable for Bearings	Stabilizing Rings Req'd		Interchange FAG SKF STEYR
	d	d1	d2	H	H1	E	A	b	L			No.	QTY	
SN-304	20	-	25	40	75	130	165	46	70	3.090	6304, 1304, 20304, 21304	FR 52/7	2	SN 304
SN-305	25	20	30	50	90	150	185	52	80	4.190	6305, 1305, 20305, 21305	FR 62/9	2	SN 305
SN-306	30	25	35	50	95	150	185	52	82	4.630	6306, 1306, 20306, 21306	FR 72/9	2	SN 306
SN-307	35	30	45	60	110	170	205	60	90	6.620	6307, 1307, 20307, 21307	FR 80/10	2	SN 307
SN-308	40	35	50	60	115	170	205	60	95	7.280	6308, 1308, 20308, 21308	FR 90/10	2	SN 308
SN-309	45	40	55	70	130	210	255	70	105	10.100	6309, 1309, 20309, 21309	FR 100/11	2	SN 309
SN-310	50	45	60	70	135	210	255	70	115	11.200	6310, 1310, 20310, 21310	FR 110/12	2	SN 310
SN-311	55	50	65	80	150	230	275	80	120	14.300	6311, 1311, 20311, 21311	FR 120/12	2	SN 311
SN-312	60	55	70	80	155	230	280	80	125	15.900	6312, 1312, 20312, 21312	FR 130/13	2	SN 312
SN-313	65	60	75	95	175	260	315	90	130	21.300	6313, 1313, 20313, 21313	FR 140/13	2	SN 313
SN-314	70	-	80	95	185	260	320	90	130	23.200	6314, 1314, 20314, 21314	FR 150/13	2	SN 314
SN-315	75	65	85	100	195	290	345	100	140	30.900	6315, 1315, 20315, 21315	FR 160/14	2	SN 315
SN-316	80	70	90	112	210	290	345	100	145	30.400	6316, 1316, 20316, 21316	FR 170/15	2	SN 316
SN-317	85	75	95	112	215	320	380	110	155	34.800	6317, 1317, 20317, 21317	FR 180/15	2	SN 317
SN-318	90	80	100	112	220	320	380	110	160	41.000	6318, 1318, 20318, 21318	FR 190/15	2	SN 318
SN-319	95	85	110	125	240	350	410	120	170	47.400	6319, 1319, 20319, 21319	FR 200/16	2	SN 319
SN-320	100	90	115	140	270	350	410	120	175	54.200	6320, 1320, 20320, 21320	FR 215/18	2	SN 320
SN-322	110	100	125	150	295	390	450	130	190	69.200	6322, 1322, 20322, 21322	FR 240/20	2	SN 322
SN-324	120	110	135	160	320	450	530	160	205	104.000	6324, 20324	FR 260/20.5	2	SN 324
SN-326	130	115	150	170	340	470	550	160	215	121.000	6326, 20326	FR 280/22.5	2	SN 326
SN-304	20	-	25	40	75	130	165	46	70	3.090	2304	FR 52/8	1	SN 304
SN-305	25	20	30	50	90	150	185	52	80	4.190	2305	FR 62/10	1	SN 305
SN-306	30	25	35	50	95	150	185	52	82	4.630	2306	FR 72/10	1	SN 306
SN-307	35	30	45	60	110	170	205	60	90	6.620	2307	FR 80/10	1	SN 307
SN-308	40	35	50	60	115	170	205	60	95	7.280	2308, 22308	FR 90/10	1	SN 308
SN-309	45	40	55	70	130	210	255	70	105	10.100	2309, 22309	FR 100/10	1	SN 309
SN-310	50	45	60	70	135	210	255	70	115	11.200	2310, 22310	FR 110/10	1	SN 310
SN-311	55	50	65	80	150	230	275	80	120	14.300	2311, 22311	FR 120/10	1	SN 311
SN-312	60	55	70	80	155	230	280	80	125	15.900	2312, 22312	FR 130/10	1	SN 312
SN-313	65	60	75	95	175	260	315	90	130	21.300	2313, 22313	FR 140/10	1	SN 313
SN-314	70	-	80	95	185	260	320	90	130	23.200	2314, 22314	FR 150/10	1	SN 314
SN-315	75	65	85	100	195	290	345	100	140	30.900	2315, 22315	FR 160/10	1	SN 315
SN-316	80	70	90	112	210	290	345	100	145	30.400	2316, 22316	FR 170/10	1	SN 316
SN-317	85	75	95	112	215	320	380	110	155	34.800	2317, 22317	FR 180/10	1	SN 317
SN-318	90	80	100	112	220	320	380	110	160	41.000	2318, 22318	FR 190/10	1	SN 318
SN-319	95	85	110	125	240	350	410	120	170	47.400	2319, 22319	FR 200/10	1	SN 319
SN-320	100	90	115	140	270	350	410	120	175	54.200	2320, 22320	FR 215/10	1	SN 320
SN-322	110	100	125	150	295	390	450	130	190	69.200	2322, 22322	FR 240/10	1	SN 322
SN-324	120	110	135	160	320	450	530	160	205	104.000	22324	FR 260/10	1	SN 324
SN-326	130	115	150	170	340	470	550	160	215	121.000	22326	FR 280/10	1	SN 326

NOTE:

- 1.) The above are cast-iron split housings and are equipped with felt seals.
- 2.) Felt seals can be substituted with SN-... TA rubber seals. These seals are not interchangeable with housings from other manufacturers. Consult factory for availability.
- 3.) The above series has two bolt bases and two bolt caps.

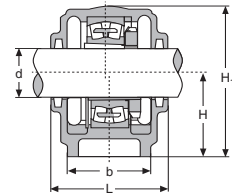
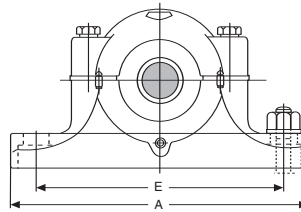

PILLOW BLOCKS - HOUSING ONLY

Consolidated Housing No.	Dimensions (Metric)							Housing Only Approx. Wgt. lbs.	Suitable for Bearings	Stabilizing Rings Req'd	Suitable Adapters	Interchange FAG SKF STEYR	
	d	H	H1	E	A	b	L						No.
SN-505	20	40	75	130	165	46	67	3.090	1205-K, 20205-K	FR 52/5	2	H-205x20mm.	SN 505
SN-506	25	50	90	150	185	52	77	4.190	1206-K, 20206-K	FR 62/7	2	H-206x25mm.	SN 506
SN-507	30	50	95	150	185	52	82	4.630	1207-K, 20207-K	FR 72/8	2	H-207x30mm.	SN 507
SN-508	35	60	110	170	205	60	85	6.840	1208-K, 20208-K	FR 80/8	2	H-208x35mm.	SN 508
SN-509	40	60	110	170	205	60	85	6.390	1209-K, 20209-K	FR 85/6	2	H-209x40mm.	SN 509
SN-510	45	60	115	170	205	60	90	7.280	1210-K, 20210-K	FR 90/7	2	H-210x45mm.	SN 510
SN-511	50	70	130	210	255	70	95	10.100	1211-K, 20211-K	FR 100/6	2	H-211x50mm.	SN 511
SN-512	55	70	135	210	255	70	105	11.900	1212-K, 20212-K	FR 110/8	2	H-212x55mm.	SN 512
SN-513	60	80	150	230	275	80	110	14.800	1213-K, 20213-K	FR 120/10	2	H-213x60mm.	SN 513
SN-515	65	80	155	230	280	80	115	16.100	1215-K, 20215-K	FR 130/8	2	H-215x65mm.	SN 515
SN-516	70	95	175	260	315	90	120	20.500	1216-K, 20216-K	FR 140/9	2	H-216x70mm.	SN 516
SN-517	75	95	185	260	320	90	125	21.600	1217-K, 20217-K	FR 150/9	2	H-217x75mm.	SN 517
SN-518	80	100	195	290	345	100	145	27.600	1218-K, 20218-K	FR 160/16	2	H-218x80mm.	SN 518
SN-520	90	112	215	320	380	110	160	37.500	1220-K, 20220-K	FR 180/18	2	H-220x90mm.	SN 520
SN-522	100	125	240	350	410	120	175	40.800	1222-K, 20222-K	FR 200/21	2	H-222x100mm.	SN 522
SN-505	20	40	75	130	165	46	67	3.090	2205-K, 22205-K	FR 52/7	1	H-305x20mm.	SN 505
SN-506	25	50	90	150	185	52	77	4.190	2206-K, 22206-K	FR 62/10	1	H-306x25mm.	SN 506
SN-507	30	50	95	150	185	52	82	4.630	2207-K, 22207-K	FR 72/10	1	H-307x30mm.	SN 507
SN-508	35	60	110	170	205	60	85	6.840	2208-K, 22208-K	FR 80/10	1	H-308x35mm.	SN 508
SN-509	40	60	110	170	205	60	85	6.390	2209-K, 22209-K	FR 85/8	1	H-309x40mm.	SN 509
SN-510	45	60	115	170	205	60	90	7.280	2210-K, 22210-K	FR 90/10	1	H-310x45mm.	SN 510
SN-511	50	70	130	210	255	70	95	10.100	2211-K, 22211-K	FR 100/8	1	H-311x50mm.	SN 511
SN-512	55	70	135	210	255	70	105	11.900	2212-K, 22212-K	FR 110/10	1	H-312x55mm.	SN 512
SN-513	60	80	150	230	275	80	110	14.800	2213-K, 22213-K	FR 120/12	1	H-313x60mm.	SN 513
SN-515	65	80	155	230	280	80	115	16.100	2215-K, 22215-K	FR 130/10	1	H-315x65mm.	SN 515
SN-516	70	95	175	260	315	90	120	20.500	2216-K, 22216-K	FR 140/10	1	H-316x70mm.	SN 516
SN-517	75	95	185	260	320	90	125	21.600	2217-K, 22217-K	FR 150/10	1	H-317x75mm.	SN 517
SN-518	80	100	195	290	345	100	145	27.600	2218-K, 22218-K	FR 160/11	2	H-318x80mm.	SN 518
SN-520	90	112	215	320	380	110	160	37.500	2220-K, 22220-K	FR 180/12	2	H-320x90mm.	SN 520
SN-522	100	125	240	350	410	120	175	40.800	23220-K 23222-K 23222-K	FR 180/10 FR 200/14 FR 200/10	1 2 1	H-2320x90mm. H-322x100mm. H-2322x100mm.	SN 522
SN-524	110	140	270	350	410	120	185	54.000	22224-K 23224-K	FR 215/14 FR 215/10	2 1	H-3124x110mm. H-2324x110mm.	SN 524
SN-526	115	150	290	380	445	130	190	66.200	22226-K	FR 230/13	2	H-3126x115mm.	SN 526
SN-528	125	150	305	420	500	150	205	83.800	23226-K 22228-K 23228-K	FR 230/10 FR 250/15 FR 250/10	1 2 1	H-2326x115mm. H-3128x125mm. H-2328x125mm.	SN 528
SN-530	135	160	325	450	530	160	220	100.000	22230-K 23230-K	FR 270/17 FR 270/10	2 1	H-3130x135mm. H-2330x135mm.	SN 530
SN-532	140	170	345	470	550	160	235	119.000	22232-K 23232-K	FR 290/17 FR 290/10	2 1	H-3132x140mm. H-2332x140mm.	SN 532

NOTE:

- 1.) The above are cast-iron split housings and are equipped with felt seals.
- 2.) Felt seals can be substituted with SN-... TA rubber seals. These seals are not interchangeable with housings from other manufacturers. Consult factory for availability.
- 3.) The above series has two bolt bases and two bolt caps.

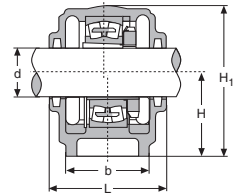
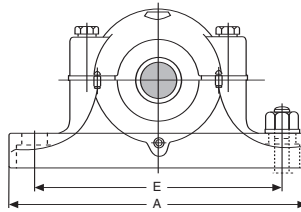

PILLOW BLOCKS - HOUSING ONLY

Consolidated Housing No.	Dimensions (Metric)							Housing Only Approx. Wgt. lbs.	Suitable for Bearings	Stabilizing Rings Req'd		Suitable Adapters	Interchange FAG SKF STEYR
	d	H	H1	E	A	b	L			No.	QTY		
SN-605	20	50	90	150	185	52	80	4.410	1305-K, 20305-K	FR 62/9	2	H-305x20mm.	SN 605
SN-606	25	50	95	150	185	52	82	4.850	1306-K, 20306-K	FR 72/9	2	H-306x25mm.	SN 606
SN-607	30	60	110	170	205	60	90	7.280	1307-K, 20307-K	FR 80/10	2	H-307x30mm.	SN 607
SN-608	35	60	115	170	205	60	95	7.500	1308-K, 20308-K, 21308-K	FR 90/10	2	H-308x35mm.	SN 608
SN-609	40	70	130	210	255	70	105	10.400	1309-K, 20309-K, 21309-K	FR 100/11	2	H-309x40mm.	SN 609
SN-610	45	70	135	210	255	70	115	11.000	1310-K, 20310-K, 21310-K	FR 110/12	2	H-310x45mm.	SN 610
SN-611	50	80	150	230	275	80	120	14.600	1311-K, 20311-K, 21311-K	FR 120/12	2	H-311x50mm.	SN 611
SN-612	55	80	155	230	280	80	125	16.100	1312-K, 20312-K, 21312-K	FR 130/13	2	H-312x55mm.	SN 612
SN-613	60	95	175	260	315	90	130	21.800	1313-K, 20313-K, 21313-K	FR 140/13	2	H-313x60mm.	SN 613
SN-615	65	100	195	290	345	100	140	31.500	1315-K, 20315-K, 21315-K	FR 160/14	2	H-315x65mm.	SN 615
SN-616	70	112	210	290	345	100	145	30.600	1316-K, 20316-K, 21316-K	FR 170/15	2	H-316x70mm.	SN 616
SN-617	75	112	215	320	380	110	155	33.100	1317-K, 20317-K, 21317-K	FR 180/15	2	H-317x75mm.	SN 617
SN-618	80	112	220	320	380	110	160	41.900	1318-K, 20318-K, 21318-K	FR 190/15	2	H-318x80mm.	SN 618
SN-620	90	140	270	350	410	120	175	55.100	1320-K, 20320-K, 21320-K	FR 215/18	2	H-320x90mm.	SN 620
SN-605	20	50	90	150	185	52	80	4.410	2305-K	FR 62/10	1	H-2305x20mm.	SN 605
SN-606	25	50	95	150	185	52	82	4.850	2306-K	FR 72/10	1	H-2306x25mm.	SN 606
SN-607	30	60	110	170	205	60	90	7.280	2307-K	FR 80/10	1	H-2307x30mm.	SN 607
SN-608	35	60	115	170	205	60	95	7.500	2308-K, 22308-K	FR 90/10	1	H-2308x35mm.	SN 608
SN-609	40	70	130	210	255	70	105	10.400	2309-K, 22309-K	FR 100/10	1	H-2309x40mm.	SN 609
SN-610	45	70	135	210	255	70	115	11.000	2310-K, 22310-K	FR 110/10	1	H-2310x45mm.	SN 610
SN-611	50	80	150	230	275	80	120	14.600	2311-K, 22311-K	FR 120/10	1	H-2311x50mm.	SN 611
SN-612	55	80	155	230	280	80	125	16.100	2312-K, 22312-K	FR 130/10	1	H-2312x55mm.	SN 612
SN-613	60	95	175	260	315	90	130	21.800	2313-K, 22313-K	FR 140/10	1	H-2313x60mm.	SN 613
SN-615	65	100	195	290	345	100	140	31.500	2315-K, 22315-K	FR 160/10	1	H-2315x65mm.	SN 615
SN-616	70	112	210	290	345	100	145	30.600	2316-K, 22316-K	FR 170/10	1	H-2316x70mm.	SN 616
SN-617	75	112	215	320	380	110	155	33.100	2317-K, 22317-K	FR 180/10	1	H-2317x75mm.	SN 617
SN-618	80	112	220	320	380	110	160	41.900	2318-K, 22318-K	FR 190/10	1	H-2318x80mm.	SN 618
SN-620	90	140	270	350	410	120	175	55.100	2320-K, 22320-K	FR 215/10	1	H-2320x90mm.	SN 620
SN-622	100	150	295	390	450	130	190	70.600	22322-K	FR 240/10	1	H-2322x100mm.	SN 622
SN-624	110	160	320	450	530	160	205	106.000	22324-K	FR 260/10	1	H-2324x110mm.	SN 624
SN-626	115	170	340	470	550	160	215	123.000	22326-K	FR 280/10	1	H-2326x115mm.	SN 626
SN-628	125	180	367	520	620	170	235	159.000	22328-K	FR 300/10	1	H-2328x125mm.	SN 628
SN-630	135	190	385	560	650	180	245	216.000	22330-K	FR 320/10	1	H-2330x135mm.	SN 630
SN-632	140	200	405	580	680	190	255	254.000	22332-K	FR 340/10	1	H-2332x140mm.	SN 632

NOTE:

- 1.) The above are cast-iron split housings and are equipped with felt seals.
- 2.) Felt seals can be substituted with SN-.. TA rubber seals. These seals are not interchangeable with housings from other manufacturers. Consult factory for availability.
- 3.) The above series has two bolt bases and two bolt caps.

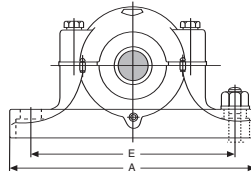

SN-3000

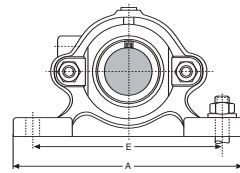
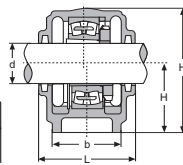

TN

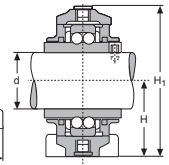

PILLOW BLOCKS - HOUSING ONLY

Consolidated Housing No.	Dimensions (Metric)							Housing Only Approx. Wgt. lbs.	Stabilizing Rings Req'd No.	QTY	Suitable Adapters	Suitable for Bearing
	d	b	E	A	L	H	H1					
SN-3024	110	110	320	380	150	112	217	37.478	FR-180/10	1	H-3024x110mm	23024-K
SN-3026	115	120	350	410	160	125	240	44.092	FR-200/10	1	H-3026x115mm	23026-K
SN-3028	125	120	350	410	170	140	260	55.115	FR-210/10	1	H-3028x125mm	23028-K
SN-3030	135	130	380	445	175	150	283	66.138	FR-225/10	1	H-3030x135mm	23030-K
SN-3032	140	130	390	460	190	150	290	81.570	FR-240/10	1	H-3032x140mm	23032-K
SN-3034	150	160	450	530	200	160	310	101.412	FR-260/10	1	H-3034x150mm	23034-K
SN-3036	160	160	470	550	210	170	330	121.253	FR-280/10	1	H-3036x160mm	23036-K
SN-3038	170	160	470	550	210	170	335	132.276	FR-290/10	1	H-3038x170mm	23038-K
SN-3040	180	170	515	610	235	180	366	176.368	FR-310/10	1	H-3040x180mm	23040-K
SN-3044	200	190	580	690	255	200	401	231.483	FR-340/10	1	H-3044x200mm	23044-K
SN-3048	220	200	610	720	265	210	422	275.575	FR-360/10	1	H-3048x220mm	23048-K
SN-3052	240	220	680	820	285	240	472	352.736	FR-400/10	1	H-3052x240mm	23052-K
SN-3056	260	230	720	860	295	250	495	396.828	FR-420/10	1	H-3056x260mm	23056-K
SN-3122	100	110	320	380	155	112	217	39.683	FR-180/10	1	H-3122x100mm	23122-K
SN-3124	110	120	350	410	165	125	240	46.297	FR-200/10	1	H-3124x110mm	23124-K
SN-3126	115	120	350	410	170	140	260	57.320	FR-210/10	1	H-3126x115mm	23126-K
SN-3128	125	130	380	445	180	150	283	70.547	FR-225/10	1	H-3128x125mm	23128-K
SN-3130	135	150	420	500	200	150	295	88.184	FR-250/10	1	H-3130x135mm	23130-K
SN-3132	140	160	450	530	215	160	315	110.230	FR-270/10	1	H-3132x140mm	23132-K
SN-3134	150	160	470	550	220	170	330	125.662	FR-280/10	1	H-3134x150mm	23134-K
SN-3136	160	170	520	610	230	180	355	154.322	FR-300/10	1	H-3136x160mm	23136-K
SN-3138	170	180	560	650	240	190	375	187.391	FR-320/10	1	H-3138x170mm	23138-K

NOTE:

- 1.) The above are cast-iron split housings and are equipped with rubber seals.
- 2.) The above series has two bolt bases and two bolt caps.

PILLOW BLOCKS - HOUSING ONLY

Consolidated Housing No.	Dimensions (Metric)					Housing Only Approx. Wgt. lbs.	Suitable for Bearings	Interchange		
	d	H	H1	E	A		FAG	SKF	STEYR	
TN-204	20	40	75	115	145	1.980	11204	TN 204	TN 204	TN 204
TN-205	25	40	78	120	150	2.430	11205	TN 205	TN 205	TN 205
TN-206	30	50	93	130	165	3.530	11206	TN 206	TN 206	TN 206
TN-207	35	50	98	145	180	3.750	11207	TN 207	TN 207	TN 207
TN-208	40	55	108	160	195	4.630	11208	TN 208	TN 208	TN 208
TN-209	45	60	115	175	210	6.390	11209	TN 209	TN 209	TN 209
TN-210	50	60	119	175	210	6.170	11210	TN 210	TN 210	TN 210
TN-211	55	65	129	190	230	7.500	11211	TN 211	TN 211	-
TN-212	60	70	140	205	245	8.600	11212	TN 212	TN 212	-
TN-304	20	40	78	120	150	2.430	11304	TN 304	-	TN 304
TN-305	25	50	93	130	165	3.530	11305	TN 305	-	TN 305
TN-306	30	50	98	145	180	3.750	11306	TN 306	-	TN 306
TN-307	35	55	108	160	195	4.850	11307	TN 307	-	TN 307
TN-308	40	60	119	175	210	6.170	11308	TN 308	-	TN 308
TN-309	45	65	129	190	230	7.500	11309	TN 309	-	TN 309
TN-310	50	70	140	205	245	8.600	11310	TN 310	-	TN 310
TN-504	20	40	75	115	145	2.210	11504	TN 504	-	-
TN-505	25	40	78	120	150	2.430	11505	TN 505	-	-
TN-506	30	50	93	130	165	3.530	11506	TN 506	-	-
TN-507	35	50	98	145	180	3.970	11507	TN 507	-	-
TN-508	40	55	108	160	195	4.850	11508	TN 508	-	-
TN-509	45	60	115	175	210	6.390	11509	TN 509	-	-
TN-510	50	60	119	175	210	6.620	11510	TN 510	-	-

NOTE:

- 1.) Above housings are made of cast iron and are equipped with felt seals.



PILLOW BLOCKS - HOUSING ONLY (INCH DIMENSIONS)

Consolidated Housing No.	Dimensions (Inch)								Housing Only Approx. Wgt. (lbs.)	Suitable Bearings and Stabilizing Rings		
	d	d1	H	H1	E	A	F	C		Brg.	Ball Ring No.	Qty.
*SAF-216	3.6250	3.0000	3.5000	6.8750	10.3125	13.0000	2.1250	3.5000	24.500	-	-	-
*SAF-217	3.9375	3.1875	3.7500	7.3125	10.4375	13.0000	2.1250	3.5000	26.400	-	-	-
*SAF-218	4.1250	3.3750	4.0000	7.7500	11.0000	13.7500	2.1250	3.8750	32.400	-	-	-
*SAF-220	4.5000	3.8125	4.5000	8.7500	12.3750	15.2500	2.3750	4.3750	43.500	-	-	-
SAF-222	4.8750	4.1875	4.9375	9.6250	13.5625	16.5000	2.7500	4.7500	53.000	-	-	-
SAF-224	5.3125	4.5625	5.2500	10.2500	13.8750	16.5000	2.7500	4.7500	62.000	-	-	-
SAF-226	5.8750	4.9375	6.0000	11.5000	15.1875	18.3750	3.2500	5.1250	93.000	-	-	-
SAF-228	6.2500	5.3125	6.0000	11.7500	16.5625	20.1250	3.3750	5.8750	108.000	-	-	-
SAF-230	6.6250	5.7500	6.3125	12.5000	17.6250	21.2500	3.7500	6.2500	121.000	-	-	-
SAF-232	7.0000	6.0625	6.6875	13.3125	18.3125	22.0000	3.7500	6.2500	146.000	-	-	-
SAF-234	7.4375	6.4375	7.0625	14.1875	20.5000	24.7500	4.2500	6.7500	202.000	-	-	-
SAF-236	7.8125	6.8750	7.5000	14.8750	22.2500	26.7500	4.6250	7.1250	229.000	-	-	-
SAF-238	8.3750	7.2500	7.8750	15.6875	23.0000	28.0000	4.5000	7.5000	275.000	-	-	-
SAF-240	8.7500	7.6250	8.2500	16.5000	23.7500	29.5000	5.0000	8.0000	302.000	-	-	-
SAF-244	9.5625	8.3125	9.5000	18.6250	26.3125	32.7500	5.2500	8.7500	431.000	-	-	-

*Also available in four-bolt base. Use "FSAF" prefix. Example: FSAF-217

SAF-308	1.9375	1.4375	2.5000	4.8125	6.7500	8.5000	-	2.3750	10.000	1308	SR-1608	2
SAF-309	2.1250	1.6875	2.7500	5.3125	7.6250	9.6250	-	2.7500	12.000	1309	SR-1609	2
SAF-310	2.3750	1.8750	3.0000	5.8125	8.3750	10.6250	-	2.7500	15.900	1310	SR-1610	2
*SAF-311	2.5625	2.0625	3.2500	6.1875	8.8125	11.0000	2.0000	3.1250	19.900	1311	SR-1611	2
*SAF-313	3.0625	2.4375	3.5000	6.9375	10.3125	13.0000	2.1250	3.5000	28.500	1313	SR-1613	2
*SAF-315	3.5375	2.8125	4.0000	7.8125	11.0000	13.7500	2.1250	3.8750	39.000	1315	SR-1615	2
*SAF-316	3.6250	3.0000	4.2500	8.2500	11.6250	14.2500	2.1250	3.8750	48.000	1316	SR-1616	2
*SAF-317	3.9375	3.1875	4.5000	8.7500	12.3750	15.2500	2.3750	4.3750	55.000	1317	SR-1617	2
SAF-318	4.1250	3.3750	4.7500	9.1875	12.7500	15.5000	2.2500	4.3750	60.000	1318	SR-1618	2
SAF-320	4.5000	3.8125	5.2500	10.2500	13.8750	16.5000	2.7500	4.7500	71.000	1320	SR-1620	2
SAF-322	4.8750	4.1875	6.0000	11.5000	15.3125	18.3750	3.2500	5.1250	98.000	1322	SR-1622	2
SAF-324	5.3125	4.5625	6.3125	12.5000	17.6250	21.2500	3.7500	6.2500	137.000	-	-	-
SAF-326	5.8750	4.9375	6.6875	13.3125	18.3125	22.0000	3.7500	6.2500	161.000	-	-	-
SAF-328	6.2500	5.3125	7.0625	14.1875	20.5000	24.7500	4.2500	6.7500	210.000	-	-	-
SAF-330	6.6250	5.7500	7.5000	14.8750	22.2500	26.7500	4.6250	7.1250	229.000	-	-	-
SAF-332	7.0000	6.0625	7.8750	15.6875	23.0000	28.0000	4.5000	7.5000	278.000	-	-	-
SAF-334	7.4375	6.4375	8.2500	16.5000	23.7500	29.5000	5.0000	8.0000	319.000	-	-	-
SAF-336	7.8125	6.8750	8.8750	17.7500	25.3125	31.2500	5.2500	8.2500	356.000	-	-	-
SAF-338	8.3750	7.2500	9.5000	18.6250	26.1250	32.7500	5.2500	8.7500	447.000	-	-	-
SAF-340	8.7500	7.6250	9.8750	20.0000	27.8750	34.2500	5.5000	9.0000	471.000	-	-	-

*Also available in four-bolt base. Use "FSAF" prefix. Example: FSAF-317.

NOTE:

- 1.) The above are split cast iron housings. For cast steel housings use "SAFS" prefix. Example: SAFS-317.
- 2.) Sizes SAF-222 and larger & sizes SAF-318 and larger are all four-bolt base units.
- 3.) Taconite seals (TER-.V) can be used in place of the standard LER seal. Example: TER-17V replaces LER-17

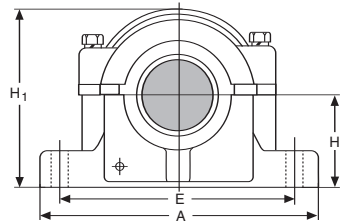
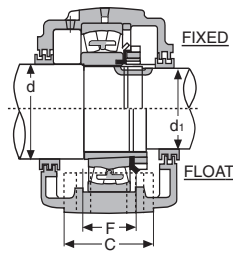

Triple Ring Seals Req'd

Brg.	Roller Ring No.	Qty.	No.	Seal Qty	Seal No.	Qty.	Appropriate End Plug	Locknut	Lock-washer	Interchange SKF Torrington
22216	SR-16-13	1	LER 82	1	LER 54	1	EPR-9	AN-16	W-16	SAF 216
22217	SR-17-14	1	LER 89	1	LER 63	1	EPR-9	AN-17	W-17	SAF 217
22218	SR-18-15	1	LER 112	1	LER 191	1	EPR-11	AN-18	W-18	SAF 218
22220	SR-20-17	1	LER 118	1	LER 106	1	EPR-12	AN-20	W-20	SAF 220
22222	SR-22-19	1	LER 121	1	LER 113	1	EPR-14	AN-22	W-22	SAF 222
22224	SR-24-20	1	LER 127	1	LER 119	1	EPR-15	AN-24	W-24	SAF 224
22226	SR-26-0	1	LER 136	1	LER 122	1	EPR-27	AN-26	W-26	SAF 226
22228	SR-28-0	1	LER 144	1	LER 127	1	EPR-16	AN-28	W-28	SAF 228
22230	SR-30-0	1	LER 151	1	LER 134	1	EPR-17	AN-30	W-30	SAF 230
22232	SR-32-0	1	LER 156	1	LER 142	1	EPR-18	AN-32	W-32	SAF 232
22234	SR-34-0	1	LER 161	1	LER 148	1	EPR-19	AN-34	W-34	SAF 234
22236	SR-36-30	1	LER 165	1	LER 154	1	EPR-20	AN-36	W-36	SAF 236
22238	SR-38-32	1	LER 171	1	LER 160	1	EPR-21	AN-38	W-38	SAF 238
22240	SR-40-34	1	LER 175	1	LER 164	1	EPR-22	AN-40	W-40	SAF 240
22244	SR-44-38	1	LER 179	1	LER 170	1	EPR-24	N-44	W-44	SAF 244
22308	SR-10-8	1	LER 24	1	LER 17	1	EPR-3	N-08	W-08	SAF 308
22309	SR-11-9	1	LER 28	1	LER 20	1	EPR-4	N-09	W-09	SAF 309
22310	SR-0-10	1	LER 35	1	LER 23	1	EPR-5	N-10	W-10	SAF 310
22311	SR-13-11	1	LER 40	1	LER 27	1	EPR-6	N-11	W-11	SAF 311
22313	SR-16-13	1	LER 55	1	LER 37	1	EPR-7	N-13	W-13	SAF 313
22315	SR-18-15	1	LER 79	1	LER 46	1	EPR-8	AN-15	W-15	SAF 315
22316	SR-19-16	1	LER 84	1	LER 60	1	EPR-10	AN-16	W-16	SAF 316
22317	SR-20-17	1	LER 109	1	LER 188	1	EPR-11	AN-17	W-17	SAF 317
22318	SR-21-18	1	LER 112	1	LER 191	1	EPR-11	AN-18	W-18	SAF 318
22320	SR-24-20	1	LER 118	1	LER 106	1	EPR-12	AN-20	W-20	SAF 320
22322	SR-0-22	1	LER 121	1	LER 113	1	EPR-14	AN-22	W-22	SAF 322
22324	SR-0-24	1	LER 127	1	LER 119	1	EPR-15	AN-24	W-24	SAF 324
22326	SR-0-26	1	LER 136	1	LER 122	1	EPR-27	AN-26	W-26	SAF 326
22328	SR-0-28	1	LER 144	1	LER 127	1	EPR-16	AN-28	W-28	SAF 328
22330	SR-36-30	1	LER 151	1	LER 134	1	EPR-17	AN-30	W-30	SAF 330
22332	SR-38-32	1	LER 156	1	LER 142	1	EPR-18	AN-32	W-32	SAF 332
22334	SR-40-34	1	LER 161	1	LER 148	1	EPR-19	AN-34	W-34	SAF 334
22336	SR-0-36	1	LER 165	1	LER 154	1	-	AN-36	W-36	SAF 336
22338	SR-44-38	1	LER 171	1	LER 160	1	EPR-21	AN-38	W-38	SAF 338
22340	SR-0-40	1	LER 175	1	LER 164	1	EPR-22	AN-40	W-40	SAF 340



PILLOW BLOCKS - HOUSING ONLY (INCH DIMENSIONS)

Consolidated Housing No.	Dimensions (Inch)							Housing Only Approx. Wgt. (lbs.)	Bearing
	d	H	H1	E	A	F	C		
SAF-509	1.4375	2.2500	4.3750	6.6250	8.2500	-	2.3750	8.500	1209-K
SAF-509	1.5000	2.2500	4.3750	6.6250	8.2500	-	2.3750	8.500	1209-K
SAF-510	1.6875	2.5000	4.7500	6.7500	8.2500	-	2.3750	9.300	1210-K
SAF-510	1.7500	2.5000	4.7500	6.7500	8.2500	-	2.3750	9.300	1210-K
SAF-510	1.8750	2.5000	4.7500	6.7500	8.2500	-	2.3750	9.300	1210-K
SAF-511	1.9375	2.7500	5.2500	7.6250	9.6250	-	2.7500	10.700	1211-K
SAF-511	2.0000	2.7500	5.2500	7.6250	9.6250	-	2.7500	10.700	1211-K
SAF-513	2.1875	3.0000	5.9375	8.8125	11.0000	-	3.1250	16.200	1213-K
SAF-513	2.2500	3.0000	5.9375	8.8125	11.0000	-	3.1250	16.200	1213-K
* SAF-515	2.4375	3.2500	6.3750	9.1250	11.2500	1.8750	3.1250	17.800	1215-K
* SAF-515	2.5000	3.2500	6.3750	9.1250	11.2500	1.8750	3.5000	17.800	1215-K
* SAF-516	2.6875	3.5000	6.8750	10.3125	13.0000	2.1250	3.5000	25.000	1216-K
* SAF-516	2.7500	3.5000	6.8750	10.3125	13.0000	2.1250	3.5000	25.000	1216-K
* SAF-517	2.9375	3.7500	7.3125	10.4375	13.0000	2.1250	3.5000	26.000	1217-K
* SAF-517	3.0000	3.7500	7.3125	10.4375	13.0000	2.1250	3.5000	26.000	1217-K
* SAF-518	3.1875	4.0000	7.7500	11.0000	13.7500	2.1250	3.8750	33.000	-
SAF-520	3.4375	4.5000	8.7500	12.3750	15.2500	2.3750	4.3750	44.000	-
SAF-520	3.5000	4.5000	8.7500	12.3750	15.2500	2.3750	4.3750	44.000	-
SAF-522	3.4375	4.9375	9.6250	13.5625	16.5000	2.7500	4.7500	54.000	-
SAF-522	4.0000	4.9375	9.6250	13.5625	16.5000	2.7500	4.7500	54.000	-
SAF-524	4.1875	5.2500	10.2500	13.8750	16.5000	2.7500	4.7500	63.000	-
SAF-524	4.2500	5.2500	10.2500	13.8750	16.5000	2.7500	4.7500	63.000	-
SAF-526	4.4375	6.0000	11.5000	15.3125	18.3750	3.2500	5.1250	96.000	-
SAF-526	4.5000	6.0000	11.5000	15.3125	18.3750	3.2500	5.1250	96.000	-
SAF-528	4.9375	6.0000	11.7500	16.5625	20.1250	3.3750	5.8750	111.000	-
SAF-528	5.0000	6.0000	11.7500	16.5625	20.1250	3.3750	5.8750	111.000	-
SAF-530	5.1875	6.3125	12.5000	17.6250	21.2500	3.7500	6.2500	127.000	-
SAF-532	5.4375	6.6875	13.3125	18.3125	22.0000	3.7500	6.2500	153.000	-
SAF-532	5.5000	6.6875	13.3125	18.3125	22.0000	3.7500	6.2500	153.000	-
SAF-534	5.9375	7.0625	14.1875	20.5000	24.7500	4.2500	6.7500	210.000	-
SAF-534	6.0000	7.0625	14.1875	20.5000	24.7500	4.2500	6.7500	210.000	-
SAF-536	6.4375	7.5000	14.8750	22.2500	26.7500	4.6250	7.1250	237.000	-
SAF-536	6.5000	7.5000	14.8750	22.2500	26.7500	4.6250	7.1250	237.000	-
SAF-538	6.9375	7.8750	15.6875	23.0000	28.0000	4.5000	7.5000	263.000	-
SAF-538	7.0000	7.8750	15.6875	23.0000	28.0000	4.5000	7.5000	263.000	-
SAF-540	7.1875	8.2500	16.5000	23.7500	29.5000	5.0000	8.0000	310.000	-
SAF-544	7.9375	9.5000	18.6250	26.3125	32.7500	5.2500	8.8750	440.000	-
SAF-544	8.0000	9.5000	18.6250	26.9375	32.7500	5.2500	8.8750	440.000	-

* Also available in four bolt base. Use "FSAF" prefix. Example: FSAF-520.

NOTE:

- 1.) The above are split cast iron housings. For cast steel housings use "SAFS" prefix. Example: SAFS-520.
- 2.) Size SAF-522 and larger are all four-bolt base units.
- 3.) Taconite seals (TER-..V) can be used in place of the standard LER seal. Example: TER-17V replaces LER-17

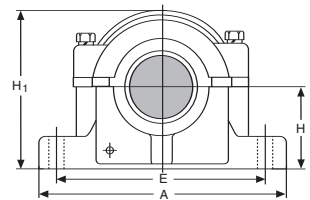
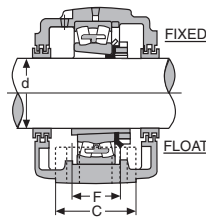

Suitable Bearings and Stabilizing Rings				Triple Ring Seals Req'd					Interchange	
Ball Ring No.	Qty.	Bearing	Roller Ring No.	Qty.	No.	Qty.	Suitable Adapter	Appropriate End Plug	FAG	SKF Torrington
SR-9-0	1	22209-K	SR-9-9	1	LER-17	2	H-309x1 7/16	EPR-3	SAF-509	
SR-9-0	1	22209-K	SR-9-9	1	LER-18	2	H-309x1 1/2	EPR-3	SAF-509	
SR-10-8	1	22210-K	SR-10-0	1	LER-20	2	H-310x1 11/16	EPR-4	SAF-510	
SR-10-8	1	22210-K	SR-10-0	1	LER-21	2	H-310x1 3/4	EPR-4	SAF-510	
SR-10-8	1	22210-K	SR-10-0	1	LER-23	2	H-310x1 7/8	EPR-4	SAF-510	
SR-11-9	1	22211-K	SR-11-0	1	LER-24	2	H-311x1 15/16	EPR-5	SAF-511	
SR-11-9	1	22211-K	SR-11-0	1	LER-25	2	H-311x2	EPR-5	SAF-511	
SR-13-0	2	22213-K	SR-13-0	1	LER-29	2	H-313x2 3/16	EPR-6	SAF-513	
SR-13-0	2	22213-K	SR-13-0	1	LER-30	2	H-313x2 1/4	EPR-6	SAF-513	
SR-15-0	2	22215-K	SR-15-0	1	LER-37	2	H-315x2 7/16	EPR-7	SAF-515	
SR-15-0	2	22215-K	SR-15-0	1	LER-38	2	H-315x2 1/2	EPR-7	SAF-515	
SR-1516	2	22216-K	SR-16-13	1	LER-44	2	H-316x2 11/16	EPR-8	SAF-516	
SR-1516	2	22216-K	SR-16-13	1	LER-45	2	H-316x2 3/4	EPR-8	SAF-516	
SR-1517	2	22217-K	SR-17-14	1	LER-53	2	H-317x2 15/16	EPR-9	SAF-517	
SR-1517	2	22217-K	SR-17-14	1	LER-54	2	H-317x3	EPR-9	SAF-517	
-	-	22218-K	SR-18-15	1	LER-188	2	H-318x3 3/16	EPR-11	SAF-518	
-	-	22220-K	SR-20-17	1	LER-102	2	H-320x3 7/16	EPR-12	SAF-520	
-	-	22220-K	SR-20-17	1	LER-103	2	H-320x3 1/2	EPR-12	SAF-520	
-	-	22222-K	SR-22-19	1	LER-109	2	H-322x3 15/16	EPR-13	SAF-522	
-	-	22222-K	SR-22-19	1	LER-110	2	H-322x4	EPR-13	SAF-522	
-	-	22224-K	SR-24-20	1	LER-113	2	H-3124x4 3/16	EPR-14	SAF-524	
-	-	22224-K	SR-24-20	1	LER-114	2	H-3124x4 1/4	EPR-14	SAF-524	
-	-	22226-K	SR-26-0	1	LER-117	2	H-3126x4 7/16	EPR-15	SAF-526	
-	-	22226-K	SR-26-0	1	LER-118	2	H-3126x4 1/2	EPR-15	SAF-526	
-	-	22228-K	SR-28-0	1	LER-122	2	H-3128x4 15/16	EPR-27	SAF-528	
-	-	22228-K	SR-28-0	1	LER-123	2	H-3128x5	EPR-27	SAF-528	
-	-	22230-K	SR-30-0	1	LER-125	2	H-3130x5 3/16	EPR-16	SAF-530	
-	-	22232-K	SR-32-0	1	LER-130	2	H-3132x5 7/16	EPR-16	SAF-532	
-	-	22232-K	SR-32-0	1	LER-131	2	H-3132x5 1/2	EPR-16	SAF-532	
-	-	22234-K	SR-34-0	1	LER-140	2	H-3134x5 15/16	EPR-18	SAF-534	
-	-	22234-K	SR-34-0	1	LER-141	2	H-3134x6	EPR-18	SAF-534	
-	-	22236-K	SR-36-30	1	LER-148	2	H-3136x6 7/16	EPR-19	SAF-536	
-	-	22236-K	SR-36-30	1	LER-149	2	H-3136x6 1/2	EPR-19	SAF-536	
-	-	22238-K	SR-38-32	1	LER-155	2	H-3138x6 15/16	EPR-20	SAF-538	
-	-	22238-K	SR-38-32	1	LER-156	2	H-3138x7	EPR-20	SAF-538	
-	-	22240-K	SR-40-34	1	LER-159	2	H-3140x7 3/16	EPR-21	SAF-540	
-	-	22244-K	SR-44-38	1	LER-167	2	H-3144x7 15/16	EPR-23	SAF-544	
-	-	22244-K	SR-44-38	1	LER-168	2	H-3144x8	EPR-23	SAF-544	



PILLOW BLOCKS - HOUSING ONLY (INCH DIMENSIONS)

Consolidated Housing No.	Dimensions (Inch)						Housing Only Approx. Wgt. (lbs.)	Suitable Bearings and Stabilizing Rings			
	d	H	H1	E	A	F		C	Bearing	Ball Ring No.	Qty.
SAF-609	1.4375	2.7500	5.3125	7.6250	9.6250	-	2.7500	13.000	1309-K	SR-1609	2
SAF-609	1.5000	2.7500	5.3125	7.6250	9.6250	-	2.7500	13.000	1309-K	SR-1609	2
SAF-610	1.6875	3.0000	5.8125	8.6250	10.6250	-	2.7500	16.700	1310-K	SR-1610	2
SAF-610	1.7500	3.0000	5.8125	8.6250	10.6250	-	2.7500	16.700	1310-K	SR-1610	2
SAF-611	1.9375	3.2500	6.1875	8.8125	11.0000	2.0000	3.2500	20.500	1311-K	SR-1611	2
SAF-611	2.0000	3.2500	6.1875	8.8125	11.0000	2.0000	3.2500	20.500	1311-K	SR-1611	2
* SAF-613	2.1875	3.5000	6.9375	10.3125	13.0000	2.1250	3.5000	29.000	1313-K	SR-1613	2
* SAF-613	2.2500	3.5000	6.9375	10.3125	13.0000	2.1250	3.5000	29.000	1313-K	SR-1613	2
* SAF-615	2.4375	4.0000	7.8125	11.0000	13.7500	2.1250	3.8750	40.000	1315-K	SR-1615	2
* SAF-615	2.5000	4.0000	7.8125	11.0000	13.7500	2.1250	3.8750	40.000	1315-K	SR-1615	2
* SAF-616	2.6875	4.2500	8.2500	11.6250	14.2500	2.1250	3.8750	49.000	1316-K	SR-1616	2
* SAF-616	2.7500	4.2500	8.2500	11.6250	14.2500	2.1250	3.8750	49.000	1316-K	SR-1616	2
* SAF-617	2.9375	4.5000	8.7500	12.3750	15.2500	2.3750	4.3750	56.000	1317-K	SR-1617	2
* SAF-617	3.0000	4.5000	8.7500	12.3750	15.2500	2.3750	4.3750	56.000	1317-K	SR-1617	2
SAF-618	3.1875	4.7500	9.1875	12.7500	15.5000	2.2500	4.3750	61.000	1318-K	SR-1618	2
SAF-618	3.2500	4.7500	9.1875	12.7500	15.5000	2.2500	4.3750	61.000	1318-K	SR-1618	2
SAF-620	3.4375	5.2500	10.2500	13.8750	16.5000	2.7500	4.7500	72.000	1320-K	SR-1620	2
SAF-620	3.5000	5.2500	10.2500	13.8750	16.5000	2.7500	4.7500	72.000	1320-K	SR-1620	2
SAF-622	3.9375	6.0000	11.5000	15.3125	18.3750	3.2500	5.1250	99.000	1322-K	SR-1622	2
SAF-622	4.0000	6.0000	11.5000	15.3125	18.3750	3.2500	5.1250	99.000	1322-K	SR-1622	2
SAF-624	4.1875	6.3125	12.5000	17.6250	21.2500	3.7500	6.2500	138.000	-	-	-
SAF-626	4.4375	6.6875	13.3125	18.3125	22.0000	3.7500	6.2500	163.000	-	-	-
SAF-626	4.5000	6.6875	13.3125	18.3125	22.0000	3.7500	6.2500	163.000	-	-	-
SAF-628	4.9375	7.0625	14.1875	20.5000	24.7500	4.2500	6.7500	214.000	-	-	-
SAF-628	5.0000	7.0625	14.1875	20.5000	24.7500	4.2500	6.7500	214.000	-	-	-
SAF-630	5.1875	7.5000	14.8750	22.3750	26.7500	4.6250	7.1250	234.000	-	-	-
SAF-632	5.4375	7.8750	15.6875	23.0000	28.0000	4.5000	7.5000	285.000	-	-	-
SAF-632	5.5000	7.8750	15.6875	23.0000	28.0000	4.5000	7.5000	285.000	-	-	-
SAF-634	5.9375	8.2500	16.5000	23.7500	29.5000	5.0000	8.0000	327.000	-	-	-
SAF-634	6.0000	8.2500	16.5000	23.7500	29.5000	5.0000	8.0000	327.000	-	-	-
SAF-636	6.4375	8.8750	17.7500	25.1875	31.2500	5.2500	8.2500	365.000	-	-	-
SAF-636	6.5000	8.8750	17.7500	25.1875	31.2500	5.2500	8.2500	365.000	-	-	-
SAF-638	6.9375	9.5000	18.6250	26.3125	32.7500	5.2500	8.7500	454.000	-	-	-
SAF-638	7.0000	9.5000	18.6250	26.3125	32.7500	5.2500	8.7500	454.000	-	-	-
SAF-640	7.1875	9.8750	20.3750	27.8750	34.2500	5.5000	9.0000	482.000	-	-	-

* Also available in four-bolt base. Use "FSAF" prefix. Example: FSAF-617

NOTE:

- 1.) The above are split cast iron housings. For cast steel housings use "SAFS" prefix. Example: SAFS-617.
- 2.) Sizes SAF-618 and larger are all four-bolt base units.
- 3.) Taconite seals (TER-..V) can be used in place of the standard LER seal. Example: TER-17V replaces LER-17

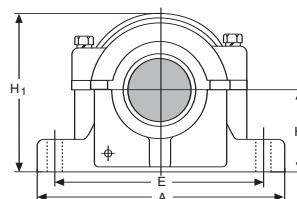
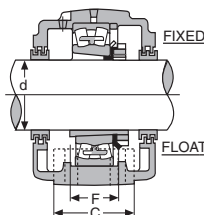

Bearing	Roller Ring No.	Qty.	Triple Ring		No.	Suitable Adapters			Appropriate End Plug	Interchange		
			Seals Req'd No.	Qty.		No.	No.	No.		FAG	SKF	Torrington
22309-K	SR-11-9	1	LER-17	2	H-309x1 7/16	H-2309x1 7/16	EPR-3		SAF 609			
22309-K	SR-11-9	1	LER-18	2	H-309x1 1/2	H-2309x1 1/2	EPR-3		SAF 609			
22310-K	SR-0-10	1	LER-20	2	H-310x1 11/16	H-2310x1 11/16	EPR-4		SAF 610			
22310-K	SR-0-10	1	LER-21	2	H-310x1 3/4	H-2310x1 3/4	EPR-4		SAF 610			
22311-K	SR-13-11	1	LER-24	2	H-311x1 15/16	H-2311x1 15/16	EPR-5		SAF 611			
22311-K	SR-13-11	1	LER-25	2	H-311x2	H-2311x2	EPR-5		SAF 611			
22313-K	SR-16-13	1	LER-32	2	H-313x2 3/16	H-2313x2 3/16	EPR-7		SAF 613			
22313-K	SR-16-13	1	LER-33	2	H-313x2 1/4	H-2313x2 1/4	EPR-7		SAF 613			
22315-K	SR-18-15	1	LER-37	2	H-315x2 7/16	H-2315x2 7/16	EPR-7		SAF 615			
22315-K	SR-18-15	1	LER-38	2	H-315x2 1/2	H-2315x2 1/2	EPR-7		SAF 615			
22316-K	SR-19-16	1	LER-44	2	H-316x2 11/16	H-2316x2 11/16	EPR-8		SAF 616			
22316-K	SR-19-16	1	LER-45	2	H-316x2 3/4	H-2316x2 3/4	EPR-8		SAF 616			
22317-K	SR-20-17	1	LER-184	2	H-317x2 15/16	H-2317x2 15/16	EPR-10		SAF 617			
22317-K	SR-20-17	1	LER-60	2	H-317x3	H-2317x3	EPR-10		SAF 617			
22318-K	SR-21-18	1	LER-188	2	H-318x3 3/16	H-2318x3 3/16	EPR-11		SAF 618			
22318-K	SR-21-18	1	LER-64	2	H-318x3 1/4	H-2318x3 1/4	EPR-11		SAF 618			
22320-K	SR-24-20	1	LER-102	2	H-320x3 7/16	H-2320x3 7/16	EPR-12		SAF 620			
22320-K	SR-24-20	1	LER-103	2	H-320x3 1/2	H-2320x3 1/2	EPR-12		SAF 620			
22322-K	SR-0-22	1	LER-109	2	H-322x3 15/16	H-2322x3 15/16	EPR-13		SAF 622			
22322-K	SR-0-22	1	LER-110	2	H-322x4	H-2322x4	EPR-13		SAF 622			
22324-K	SR-0-24	1	LER-113	2	-	H-2324x4 3/16	EPR-14		SAF 624			
22326-K	SR-0-26	1	LER-117	2	-	H-2326x4 7/16	EPR-15		SAF 626			
22326-K	SR-0-26	1	LER-118	2	-	H-2326x4 1/2	EPR-15		SAF 626			
22328-K	SR-0-28	1	LER-122	2	-	H-2328x4 15/16	EPR-27		SAF 628			
22328-K	SR-0-28	1	LER-123	2	-	H-2328x5	EPR-27		SAF 628			
22330-K	SR-36-30	1	LER-125	2	-	H-2330x5 3/16	EPR-16		SAF 630			
22332-K	SR-38-32	1	LER-130	2	-	H-2332x5 7/16	EPR-16		SAF 632			
22332-K	SR-38-32	1	LER-131	2	-	H-2332x5 1/2	EPR-16		SAF 632			
22334-K	SR-40-34	1	LER-140	2	-	H-2334x5 15/16	EPR-18		SAF 634			
22334-K	SR-40-34	1	LER-141	2	-	H-2334x6	EPR-18		SAF 634			
22336-K	SR-0-36	1	LER-148	2	-	H-2336x6 7/16	-		SAF 636			
22336-K	SR-0-36	1	LER-149	2	-	H-2336x6 1/2	-		SAF 636			
22338-K	SR-44-38	1	LER-155	2	-	H-2338x6 15/16	EPR-20		SAF 638			
22338-K	SR-44-38	1	LER-156	2	-	H-2338x7	EPR-20		SAF 638			
22340-K	SR-0-40	1	LER-159	2	-	H-2340x7 3/16	-		SAF 640			



PILLOW BLOCKS - HOUSING ONLY (INCH DIMENSIONS)

Consolidated Housing No.	Dimensions (Inch)								Approx. Wgt. (lbs.)	Triple Ring Seals Req'd		Stabilizing Rings Req'd	
	Roller	d	F	A	C	E	H	H1		No.	Qty.	No.	Qty.
SAF-24 4 3/16	4.1875	2.3750	15.2500	4.3750	12.3750	4.5000	8.7500	47.500	LER-113	2	SR-20-17	2	
SAF-26 4 7/16	4.4375	2.7500	16.5000	4.7500	13.5625	4.9375	9.6250	56.000	LER-117	2	SR-22-19	2	
SAF-28 4 15/16	4.9375	2.7500	16.5000	4.7500	13.8750	5.2500	10.2500	68.700	LER-122	2	SR-0-20	2	
SAF-30 5 3/16	5.1875	3.2500	18.3750	5.1250	15.3125	6.0000	11.5625	106.900	LER-125	2	SR-0-21	2	
SAF-32 5 7/16	5.4375	3.2500	18.3750	5.1250	15.3125	6.0000	11.5625	125.400	LER-130	2	SR-0-22	2	
SAF-34 5 15/16	5.9375	3.3750	20.1250	5.8750	16.5625	6.0000	11.7500	119.900	LER-140	2	SR-0-24	2	
SAF-36 6 7/16	6.4375	3.7500	22.0000	6.2500	18.3125	6.6875	13.5000	171.600	LER-148	2	SR-0-26	2	
SAF-38 6 15/16	6.9375	3.7500	22.0000	6.2500	18.3125	6.6875	13.5000	167.300	LER-155	2	SR-32-0	2	
SAF-40 7 3/16	7.1875	4.2500	24.7500	6.7500	20.5000	7.0625	14.3750	192.900	LER-159	2	SR-34-0	2	
SAF-44 7 15/16	7.9375	4.5000	28.0000	7.5000	23.0000	7.8750	15.8750	304.400	LER-167	2	SR-38-32	2	
SAF-48 8 7/16	8.4375	5.0000	29.5000	8.0000	23.7500	8.2500	16.5000	321.000	LER-550	2	A8897	2	
SAF-48 8 1/2	8.5000	5.0000	29.5000	8.0000	23.7500	8.2500	16.5000	321.000	LER-551	2	A8897	2	
SAF-48 8 15/16	8.9375	5.0000	29.5000	8.0000	23.7500	8.2500	16.5000	321.000	LER-552	2	A8897	2	
SAF-48 9	9.0000	5.0000	29.5000	8.0000	23.7500	8.2500	16.5000	321.000	LER-513	2	A8897	2	
SAF-52 9 7/16	9.4375	5.2500	32.7500	8.7500	26.3125	9.5000	18.6250	438.000	LER-553	2	A8898	2	
SAF-52 9 1/2	9.5000	5.2500	32.7500	8.7500	26.3125	9.5000	18.6250	438.000	LER-178	2	A8898	2	
SAF-56 9 15/16	9.9375	5.5000	34.2500	9.0000	27.8750	9.8750	20.1375	477.000	ER-751	2	A8819	2	
SAF-56 10	10.0000	5.5000	34.2500	9.0000	27.8750	9.8750	20.1375	477.000	ER-705	2	A8819	2	
SAF-56 10 7/16	10.4375	5.5000	34.2500	9.0000	27.8750	9.8750	20.1375	477.000	ER-745	2	A8819	2	
SAF-56 10 1/2	10.5000	5.5000	34.2500	9.0000	27.8750	9.8750	20.1375	477.000	ER-710	2	A8819	2	

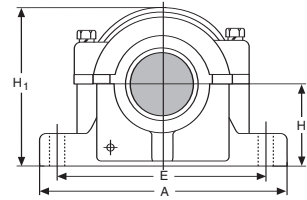
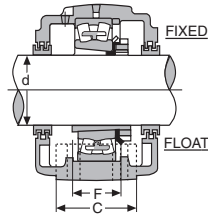

Interchange

Appropriate End Plug	Suitable Adapters	Suitable for Bearings	FAG	SKF Torrington
EPR-14	H-3024X4 3/16	23024-K	-	SAF 024
EPR-15	H-3026X4 7/16	23026-K	-	SAF 026
EPR-27	H-3028X4 15/16	23028-K	-	SAF 028
EPR-16	H-3030X5 3/16	23030-K	-	SAF 030
EPR-16	H-3032X5 7/16	23032-K	-	SAF 032
EPR-18	H-3034X5 15/16	23034-K	-	SAF 034
EPR-19	H-3036X6 7/16	23036-K	-	SAF 036
EPR-20	H-3038X6 15/16	23038-K	-	SAF 038
EPR-21	H-3040X7 3/16	23040-K	-	SAF 040
EPR-23	H-3044X7 15/16	23044-K	-	SAF 044
-	H-3048x8 7/16	23048-K	SAF 048	SAF 048
-	H-3048x8 1/2	23048-K	SAF 048	SAF 048
-	H-3048x8 15/16	23048-K	SAF 048	SAF 048
-	H-3048x9	23048-K	SAF 048	SAF 048
-	H-3052x9 7/16	23052-K	SAF 052	SAF 052
-	H-3052x9 1/2	23052-K	SAF 052	SAF 052
-	H-3056x9 15/16	23056-K	SAF 056	SAF 056
-	H-3056x10	23056-K	SAF 056	SAF 056
-	H-3056x10 7/16	23056-K	SAF 056	SAF 056
-	H-3056x10 1/2	23056-K	SAF 056	-



PILLOW BLOCKS - HOUSING ONLY (INCH DIMENSIONS)

Consolidated No.	Dimensions (Inch)								Housing Only Approx. Wgt. (lbs.)	Bearing
	d	d1	H	H1	E	A	F	C		
SDAF-220	4.5000	3.8125	4.5000	8.9375	12.3750	15.2500	3.3750	6.0000	60.000	22220
SDAF-222	4.8750	4.1875	4.9375	9.8750	13.5625	16.5000	4.0000	6.7500	80.000	22222
SDAF-224	5.3125	4.5625	5.2500	10.5000	13.8750	16.5000	4.1250	6.8750	91.000	22224
SDAF-226	5.8750	4.9375	6.0000	11.8750	15.3125	18.1875	4.5000	7.5000	112.000	22226
SDAF-228	6.2500	5.3125	6.0000	12.0625	16.5625	20.0625	4.5000	7.5000	132.000	22228
SDAF-230	6.6250	5.7500	6.3125	12.8125	17.6250	21.2500	4.7500	7.8750	143.000	22230
SDAF-232	7.0000	6.0625	6.6875	13.6875	18.3125	22.0000	5.0000	8.2500	183.000	22232
SDAF-234	7.4375	6.4375	7.0625	14.2500	20.5000	24.7500	5.5000	9.0000	225.000	22234
SDAF-236	7.8125	6.8750	7.5000	15.1875	22.2500	26.7500	5.8750	9.3750	272.000	22236
SDAF-238	8.3750	7.2500	7.8750	16.2500	22.5000	27.6250	6.2500	10.0000	298.000	22238
SDAF-240	8.7500	7.6250	8.2500	17.1250	24.0000	28.7500	6.7500	10.5000	350.000	22240
SDAF-244	9.5625	8.3125	9.5000	19.2500	26.7500	32.0000	7.2500	11.2500	470.000	22244
SDAF-316	3.6250	3.0000	4.2500	8.2500	11.6250	14.2500	3.2500	5.5000	51.000	22316
SDAF-317	3.9375	3.1875	4.5000	8.9375	12.3750	15.2500	3.3750	6.0000	63.000	22317
SDAF-318	4.1250	3.3750	4.7500	9.4375	12.7500	15.5000	3.6250	6.1250	74.000	22318
SDAF-320	4.5000	3.8125	5.2500	10.5000	13.8750	16.5000	4.1250	6.8750	92.000	22320
SDAF-322	4.8750	4.1875	6.0000	11.8750	15.3125	18.3750	4.5000	7.5000	125.000	22322
SDAF-324	5.3125	4.5625	6.3125	12.8125	17.6250	21.2500	4.7500	7.8750	152.000	22324
SDAF-326	5.8750	4.9375	6.6875	13.6875	18.3125	22.0000	5.0000	8.2500	188.000	22326
SDAF-328	6.2500	5.3125	7.0625	14.2500	20.5000	24.7500	5.5000	9.0000	234.000	22328
SDAF-330	6.6250	5.7500	7.5000	15.1875	22.2500	26.7500	5.8750	9.3750	279.000	22330
SDAF-332	7.0000	6.0625	7.8750	16.2500	22.5000	27.6250	6.2500	10.0000	310.000	22332
SDAF-334	7.4375	6.4375	8.2500	17.1250	24.0000	28.7500	6.7500	10.5000	357.000	22334
SDAF-336	7.9375	6.8750	8.8750	17.9375	25.2500	30.5000	6.8750	10.7500	435.000	22336
SDAF-338	8.3750	7.2500	9.5000	19.2500	26.7500	32.0000	7.2500	11.8750	484.000	22338
SDAF-340	8.7500	7.6250	9.8750	19.9375	27.9375	33.5000	7.6250	12.3750	527.000	22340

PILLOW BLOCKS - HOUSING ONLY (INCH DIMENSIONS)

Consolidated Housing No.	Dimensions (Inch)							Housing Only Approx. Wgt. (lbs.)	Suitable Bearings and Stabilizing Rings		
	d	H	H1	E	A	F	C		Bearing	Ring No.	Qty.
SDAF-520	3.4375	4.5000	8.9375	12.3750	15.2500	3.3750	6.0000	64.000	22220-K	SR-20-17	1
SDAF-522	3.9375	4.9375	9.8750	13.5625	16.5000	4.0000	6.7500	84.000	22222-K	SR-22-19	1
SDAF-524	4.1875	5.2500	10.5000	14.1250	16.5000	4.1250	6.8750	97.000	22224-K	SR-24-20	1
SDAF-526	4.4375	6.0000	11.8750	15.3125	18.3750	4.5000	7.5000	120.000	22226-K	SR-26-0	1
SDAF-528	4.9375	6.0000	12.0625	16.5625	20.1250	4.5000	7.5000	146.000	22228-K	SR-28-0	1
SDAF-530	5.1875	6.3125	12.8125	17.6250	21.2500	4.7500	7.8750	158.000	22230-K	SR-30-0	1
SDAF-532	5.4375	6.6875	13.6875	18.3125	22.0000	5.0000	8.2500	198.000	22232-K	SR-32-0	1
SDAF-534	5.9375	7.0625	14.2500	20.5000	24.7500	5.5000	9.0000	245.000	22234-K	SR-34-0	1
SDAF-536	6.4375	7.5000	15.1875	22.2500	26.7500	5.8750	9.3750	292.000	22236-K	SR-36-30	1
SDAF-538	6.9375	7.8750	16.2500	22.5000	27.6250	6.2500	10.0000	323.000	22238-K	SR-38-32	1
SDAF-540	7.1875	8.2500	17.1250	24.0000	28.7500	6.7500	10.5000	380.000	22240-K	SR-40-34	1
SDAF-544	7.9375	9.5000	19.2500	26.7500	32.0000	7.2500	11.2500	510.000	22244-K	SR-44-38	1
SDAF-616	2.6875	4.2500	8.2500	11.6250	14.2500	3.2500	5.5000	53.000	22316-K	SR-19-16	1
SDAF-617	2.9375	4.5000	8.9375	12.3750	15.2500	3.3750	6.0000	64.000	22317-K	SR-20-17	1
SDAF-618	3.1875	4.7500	9.4375	12.7500	15.5000	3.6250	6.1250	76.000	22318-K	SR-21-18	1
SDAF-620	3.4375	5.2500	10.5000	13.8750	16.5000	4.1250	6.8750	96.000	22320-K	SR-24-20	1
SDAF-622	3.9375	6.0000	11.8750	15.3125	18.3750	4.5000	7.5000	131.000	22322-K	SR-0-22	1
SDAF-624	4.1875	6.3125	12.8125	17.6250	21.2500	4.7500	7.8750	157.000	22324-K	SR-0-24	1
SDAF-626	4.4375	6.6875	13.6875	18.3125	22.0000	5.0000	8.2500	196.000	22326-K	SR-0-26	1
SDAF-628	4.9375	7.0625	14.2500	20.5000	24.7500	5.5000	9.0000	244.000	22328-K	SR-0-28	1
SDAF-630	5.1875	7.5000	15.1875	22.2500	26.7500	5.8750	9.3750	294.000	22330-K	SR-36-30	1
SDAF-632	5.4375	7.8750	16.2500	22.5000	27.6250	6.2500	10.0000	325.000	22332-K	SR-38-32	1
SDAF-634	5.9375	8.2500	17.1250	24.0000	28.7500	6.7500	10.5000	377.000	22334-K	SR-40-34	1
SDAF-636	6.4375	8.8750	17.9375	25.2500	30.5000	6.8750	10.7500	455.000	22336-K	SR-0-36	1
SDAF-638	6.9375	9.5000	19.2500	26.7500	32.0000	7.2500	11.2500	504.000	22338-K	SR-44-38	1
SDAF-640	7.1875	9.8750	19.9375	27.9375	33.5000	7.6250	11.7500	557.000	22340-K	SR-0-40	1

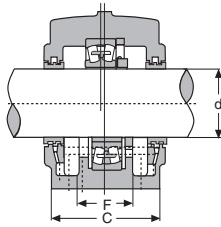

SDAF (Side View)

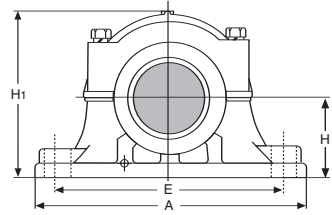

SDAF (Front View)

Interchange

Stabilizing Ring No.	Qty.	Appropriate End Plug	No.	Qty.	Triple Ring Seals	Qty.	Locknut	Lockwasher	SKF Torrington
SR-20-17	1	EPR-12	LER-118	1	LER-106	1	AN-20	W-20	SDAF-220
SR-22-19	1	EPR-14	LER-121	1	LER-113	1	AN-22	W-22	SDAF-222
SR-24-20	1	EPR-15	LER-127	1	LER-119	1	AN-24	W-24	SDAF-224
SR-26-0	1	EPR-27	LER-136	1	LER-122	1	AN-26	W-26	SDAF-226
SR-28-0	1	-	LER-144	1	LER-127	1	AN-28	W-28	SDAF-228
SR-30-0	1	EPR-17	LER-151	1	LER-134	1	AN-30	W-30	SDAF-230
SR-32-0	1	EPR-18	LER-156	1	LER-142	1	AN-32	W-32	SDAF-232
SR-34-0	1	EPR-19	LER-161	1	LER-148	1	AN-34	W-34	SDAF-234
SR-36-30	1	EPR-20	LER-165	1	LER-154	1	AN-36	W-36	SDAF-236
SR-38-32	1	EPR-22	LER-240	1	LER-229	1	AN-38	W-38	SDAF-238
SR-40-34	1	EPR-23	LER-244	1	LER-233	1	AN-40	W-40	SDAF-240
SR-44-38	1	EPR-25	LER-248	1	LER-239	1	N-44	W-44	SDAF-244
SR-19-16	1	EPR-10	LER-84	1	LER-60	1	AN-16	W-16	SDAF-316
SR-20-17	1	EPR-11	LER-109	1	LER-188	1	AN-17	W-17	SDAF-317
SR-21-18	1	EPR-11	LER-112	1	LER-191	1	AN-18	W-18	SDAF-318
SR-24-20	1	EPR-12	LER-118	1	LER-106	1	AN-20	W-20	SDAF-320
SR-0-22	1	EPR-14	LER-121	1	LER-113	1	AN-22	W-22	SDAF-322
SR-0-24	1	EPR-15	LER-127	1	LER-119	1	AN-24	W-24	SDAF-324
SR-0-26	1	EPR-17	LER-136	1	LER-122	1	AN-26	W-26	SDAF-326
SR-0-28	1	EPR-16	LER-144	1	LER-127	1	AN-28	W-28	SDAF-328
SR-36-30	1	EPR-17	LER-151	1	LER-134	1	AN-30	W-30	SDAF-330
SR-38-32	1	EPR-19	LER-225	1	LER-217	1	AN-32	W-32	SDAF-332
SR-40-34	1	EPR-26	LER-230	1	LER-220	1	AN-34	W-34	SDAF-334
SR-0-36	1	EPR-21	LER-234	1	LER-223	1	AN-36	W-36	SDAF-336
SR-44-38	1	EPR-22	LER-240	1	LER-229	1	AN-38	W-38	SDAF-338
SR-0-40	1	EPR-23	LER-244	1	LER-233	1	AN-40	W-40	SDAF-340

Interchange

No.	Qty.	Triple Ring Seals Req'd	Suitable Adapter	FAG SKF Torrington
LER-75	2		H-320x3 $\frac{7}{16}$	SDAF-520
LER-93	2		H-322x3 $\frac{15}{16}$	SDAF-522
LER-113	2		H-3124x4 $\frac{3}{16}$	SDAF-524
LER-117	2		H-3126x4 $\frac{7}{16}$	SDAF-526
LER-122	2		H-3128x4 $\frac{15}{16}$	SDAF-528
LER-125	2		H-3130x5 $\frac{3}{16}$	SDAF-530
LER-130	2		H-3132x5 $\frac{7}{16}$	SDAF-532
LER-140	2		H-3134x5 $\frac{15}{16}$	SDAF-534
LER-148	2		H-3136x6 $\frac{7}{16}$	SDAF-536
LER-224	2		H-3138x6 $\frac{15}{16}$	SDAF-538
LER-228	2		H-3140x7 $\frac{3}{16}$	SDAF-540
LER-236	2		H-3144x7 $\frac{15}{16}$	SDAF-544
LER-44	2		H-2316x2 $\frac{11}{16}$	SDAF-616
LER-59	2		H-2317x2 $\frac{15}{16}$	SDAF-617
LER-69	2		H-2318x3 $\frac{3}{16}$	SDAF-618
LER-75	2		H-2320x3 $\frac{7}{16}$	SDAF-620
LER-93	2		H-2322x3 $\frac{15}{16}$	SDAF-622
LER-113	2		H-2324x4 $\frac{3}{16}$	SDAF-624
LER-117	2		H-2326x4 $\frac{7}{16}$	SDAF-626
LER-122	2		H-2328x4 $\frac{15}{16}$	SDAF-628
LER-125	2		H-2330x5 $\frac{3}{16}$	SDAF-630
LER-211	2		H-2332x5 $\frac{7}{16}$	SDAF-632
LER-215	2		H-2334x5 $\frac{15}{16}$	SDAF-634
LER-220	2		H-2336x6 $\frac{7}{16}$	SDAF-636
LER-224	2		H-2338x6 $\frac{15}{16}$	SDAF-638
LER-228	2		H-2340x7 $\frac{3}{16}$	SDAF-640



PILLOW BLOCKS - HOUSING ONLY (METRIC & INCH DIMENSIONS)

Consolidated Housing No.	Dimensions (Metric/Inch)							Housing Only Approx. Wgt. (lbs.)	Suitable Bearings and Stabilizing Rings		
	d	H	H1	E	A	F	C		Bearing	Ring No.	Qty.
SD-3134	6.0000	170	335	430	510	100	180	154.330	23134-K	FR-280/10	2
SD-3134	150	170	335	430	510	100	180	154.330	23134-K	FR-280/10	2
SD-3136	6.5000	180	355	450	530	110	190	171.960	23136-K	FR-300/10	2
SD-3136	160	180	355	450	530	110	190	171.960	23136-K	FR-300/10	2
SD-3138	6.7500	190	375	480	560	120	210	211.650	23138-K	FR-320/10	2
SD-3138	170	190	375	480	560	120	210	211.650	23138-K	FR-320/10	2
SD-3140	7.0000	210	410	510	610	130	230	282.190	23140-K	FR-340/10	2
SD-3140	180	210	410	510	610	130	230	282.190	23140-K	FR-340/10	2
SD-3144	200	220	435	540	640	140	240	321.880	23144-K	FR-370/10	2
SD-3148	220	240	475	600	700	150	260	361.560	23148-K	FR-400/10	2
SD-3152	240	260	515	650	770	160	280	485.020	23152-K	FR-440/10	2
SD-3156	260	280	550	670	790	160	280	496.040	23156-K	FR-460/10	2
SD-3160	280	300	590	710	830	190	310	621.700	23160-K	FR-500/10	2
SD-3164	300	320	630	750	880	200	330	747.360	23164-K	FR-540/10	2
SD-3168	320	340	670	840	965	240	380	1210.330	23168-K	FR-580/10	2
SD-3172	340	360	720	890	1040	255	390	1234.580	23172-K	FR-600/10	2
SD-3176	360	380	750	980	1120	255	400	1710.770	23176-K	FR-620/10	2
SD-3180	380	400	790	1050	1245	270	420	1940.050	23180-K	FR-650/10	2

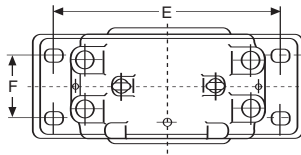

SD-3100 (Top View)

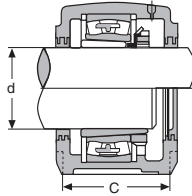

SD-3100 (Side View)

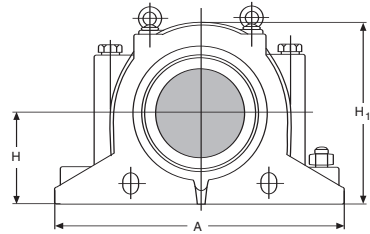

SD-3100 (Front View)

Interchange

No.	Triple Ring Seals Req'd	Qty.	Suitable Adapter	FAG SKF TORRINGTON
TS-34x6		2	H-3134x6	SD-3134
TS-34x150		2	H-3134x150mm.	SD-3134
TS-36x6 1/2		2	H-3136x6 1/2	SD-3136
TS-36x160		2	H-3136x160mm.	SD-3136
TS-38x6 3/4		2	H-3138x6 3/4	SD-3138
TS-38x170		2	H-3138x170mm.	SD-3138
TS-40x7		2	H-3140x7	SD-3140
TS-40x180		2	H-3140x180mm.	SD-3140
TS-44x200		2	H-3144x200mm.	SD-3144
TS-48x220		2	H-3148x220mm.	SD-3148
TS-52x240		2	H-3152x240mm.	SD-3152
TS-56x260		2	H-3156x260mm.	SD-3156
TS-60x280		2	H-3160x280mm.	SD-3160
TS-64x300		2	H-3164x300mm.	SD-3164
TS-68x320		2	H-3168x320mm.	-
TS-72x340		2	H-3172x340mm.	-
TS-76x360		2	H-3176x360mm.	-
TS-80x380		2	H-3180x380mm.	-

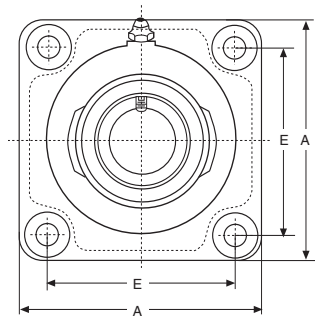
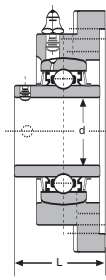

PILLOW BLOCKS - FOUR BOLT FLANGE UNITS WITH SET SCREWS

Consolidated No.	Bearing Insert No.	Dimensions (Metric / Inch)				Approx. Wgt. (lbs.)	Interchange		
		d	A	E	L		FAF	Sealmaster	SKF
FY-8	479203-008	.5000	3.0000	2.1250	1.2812	1.450	RCJC 1/2	SF-8	FY 1/2 TM
FY-10	479203-010	.6250	3.0000	2.1250	1.2812	1.450	RCJC 5/8	SF-10	FY 5/8 TM
FY-12	479204-012	.7500	3.3750	2.5000	1.3125	1.520	RCJC 3/4	SF-12	FY 3/4 TM
FY-20 SD	479204-D	20	3.3750	2.5000	1.3125	1.520	RCJ 20	SF-204	FY 20 SD
FY-14	479205-014	.8750	3.7500	2.7500	1.4218	2.100	RCJC 7/8	SF-14	FY 7/8 TM
FY-15	479205-015	.9375	3.7500	2.7500	1.4218	2.100	RCJC 15/16	SF-15	FY 15/16 TM
FY-25 SD	479205-D	25	3.7500	2.7500	1.4218	2.100	RCJ 25	SF-205	FY 25 SD
FY-100	479205-100	1.0000	3.7500	2.7500	1.4218	2.100	RCJC 1	SF-16	FY 1 TM
FY-102	479206-102	1.1250	4.2500	3.2500	1.6093	2.860	RCJC 1 1/8	SF-18	FY 1 1/8 TM
FY-30 SD	479206-D	30	4.2500	3.2500	1.6093	2.860	RCJ 30	SF-206	FY 30 SD
FY-103	479206-103	1.1875	4.2500	3.2500	1.6093	2.860	RCJC 1 3/16	SF-19	FY 1 3/16 TM
FY-104	479207-104	1.2500	4.6250	3.6250	1.7500	3.850	RCJC 1 1/4	SF-20	FY 1 1/4 TM
FY-106	479207-106	1.3750	4.6250	3.6250	1.7500	3.850	RCJC 1 3/8	SF-22	FY 1 3/8 TM
FY-35 SD	479207-D	35	4.6250	3.6250	1.7500	3.850	RCJ 35	SF-207	FY 35 SD
FY-107	479207-107	1.4375	4.6250	3.6250	1.7500	3.850	RCJC 1 7/16	SF-23	FY 1 7/16 TM
FY-108	479208-108	1.5000	5.1250	4.0000	1.9531	5.020	RCJC 1 1/2	SF-24	FY 1 1/2 TM
FY-40 SD	479208-D	40	5.1250	4.0000	1.9531	5.020	RCJ 40	SF-208	FY 40 SD
FY-110	479209-110	1.6250	5.3750	4.1250	2.0156	5.830	RCJC 1 5/8	SF-26	FY 1 5/8 TM
FY-111	479209-111	1.6875	5.3750	4.1250	2.0156	5.830	RCJC 1 11/16	SF-27	FY 1 11/16 TM
FY-112	479209-112	1.7500	5.3750	4.1250	2.0156	5.830	RCJC 1 3/4	SF-28	FY 1 3/4 TM
FY-45 SD	479209-D	45	5.3750	4.1250	2.0156	5.830	RCJ 45	SF-209	FY 45 SD
FY-115	479210-115	1.9375	5.6250	4.3750	2.0156	6.490	RCJC 1 15/16	SF-31	FY 1 15/16 TM
FY-50 SD	479210-D	50	5.6250	4.3750	2.0156	6.490	RCJ 50	SF-210	FY 50 SD
FY-200	479211-200	2.0000	6.3750	5.1250	2.2969	8.490	RCJC 2	SF-32	FY 2 TM
FY-55 SD	479211-D	55	6.3750	5.1250	2.2969	8.490	RCJ 55	SF-211	FY 55 SD
FY-203	479211-203	2.1875	6.3750	5.1250	2.2969	8.490	RCJC 2 3/16	SF-35	FY 2 3/16 TM
FY-60 SD	479212-D	60	6.8750	5.6250	2.8750	12.500	RCJ 60	SF-212	FY 60 SD
FY-204	479212-204	2.2500	6.8750	5.6250	2.8750	12.500	-	SF-38	FY 2 1/4 TM
FY-207	479212-207	2.4375	6.8750	5.6250	2.8750	12.500	RCJC 2 7/16	SF-39	FY 2 7/16 TM
FY-208	479213-208	2.5000	7.3750	5.8594	2.7500	12.500	-	SF-40	FY 2 1/2 TM
FY-65 SD	479213-D	65	7.3750	5.8594	2.7500	12.500	RCJ 65	SF-213	FY 65 SD

NOTE:

1.) Length dimension "L" may vary between all manufacturers.

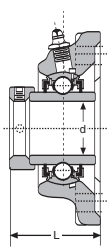

FY-..X

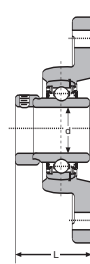
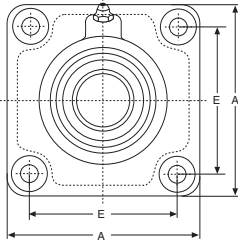

FYT-..X

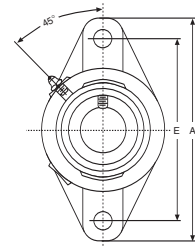

PILLOW BLOCKS - FOUR BOLT FLANGE UNITS WITH ECCENTRIC COLLAR

Consolidated No.	Bearing Insert No.	Dimensions (Inch)				Approx. Wgt. (lbs.)	Interchange		
		d	A	E	L		FAF	Sealmaster	SKF
FY-8X	477203-008	.5000	3.0000	2.1250	1.5781	1.170	RCJ 1/2	-	-
FY-10X	477203-010	.6250	3.0000	2.1250	1.5781	1.170	RCJ 5/8	-	-
FY-12X	477204-012	.7500	3.3750	2.5000	1.7969	1.610	RCJ 3/4	-	FY 3/4 WM
FY-14X	477205-014	.8750	3.7500	2.7500	1.4219	2.080	RCJ 7/8	-	FY 7/8 WM
FY-15X	477205-015	.9375	3.7500	2.7500	1.4219	2.080	RCJ 15/16	-	FY 15/16 WM
FY-100X	477205-100	1.0000	3.7500	2.7500	1.4219	2.080	RCJ 1	-	FY 1 WM
FY-102X	477206-102	1.1250	4.2500	3.2500	2.0000	2.970	RCJ 1 1/8	-	FY 1 1/8 WM
FY-103X	477206-103	1.1875	4.2500	3.2500	2.0000	2.970	RCJ 1 3/16	-	FY 1 3/16 WM
FY-104X	477207-104	1.2500	4.6250	3.6250	2.1250	3.850	RCJ 1 1/4	-	FY 1 1/4 WM
FY-106X	477207-106	1.3750	4.6250	3.6250	2.1250	3.850	RCJ 1 3/8	-	FY 1 3/8 WM
FY-107X	477207-107	1.4375	4.6250	3.6250	2.1250	3.850	RCJ 1 7/16	-	FY 1 7/16 WM
FY-108X	477208-108	1.5000	5.1250	4.0000	2.3125	5.060	RCJ 1 1/2	-	FY 1 1/2 WM
FY-110X	477209-110	1.6250	5.3750	4.1250	2.3125	5.720	RCJ 1 5/8	-	FY 1 5/8 WM
FY-111X	477209-111	1.6875	5.3750	4.1250	2.3125	5.720	RCJ 1 11/16	-	FY 1 11/16 WM
FY-112X	477209-112	1.7500	5.3750	4.1250	2.3125	5.720	RCJ 1 3/4	-	FY 1 3/4 WM
FY-114X	477210-114	1.8750	5.6250	4.3750	2.3125	6.710	RCJ 1 7/8	-	-
FY-115X	477210-115	1.9375	5.6250	4.3750	2.3125	6.710	RCJ 1 15/16	-	FY 1 15/16 WM
FY-200X	477211-200	2.0000	6.3750	5.1250	2.9687	8.490	RCJ 2	-	FY 2 WM
FY-203X	477211-203	2.1875	6.3750	5.1250	2.9687	8.490	RCJ 2 3/16	-	FY 2 3/16 WM
FY-204X	477212-204	2.2500	6.8750	5.3750	3.1875	9.900	RCJ 2 1/4	-	FY 2 1/4 WM
FY-207X	477212-207	2.4375	6.8750	5.3750	3.1875	9.350	RCJ 2 7/16	-	FY 2 7/16 WM

PILLOW BLOCKS - TWO BOLT FLANGE UNITS WITH ECCENTRIC COLLAR

FYT-8X	477203-008	.5000	3.8750	3.0000	1.6719	1.000	RCJT 1/2	SFT 8	-
FYT-10X	477203-010	.6250	3.8750	3.0000	1.6719	1.000	RCJT 5/8	SFT-10	-
FYT-12X	477204-012	.7500	4.4375	3.5312	1.7969	1.170	RCJT 3/4	SFT-12	-
FYT-14X	477205-014	.8750	5.0000	3.8906	1.8125	1.520	RCJT 7/8	SFT-14	FYT 7/8 WM
FYT-15X	477205-015	.9375	5.0000	3.8906	1.8125	1.520	RCJT 15/16	SFT-15	FYT 15/16 WM
FYT-100X	477205-100	1.0000	5.0000	3.8906	1.8125	1.520	RCJT 1	SFT-16	FYT 1 WM
FYT-102X	477206-102	1.1250	5.7031	4.5937	1.2812	2.200	RCJT 1 1/8	SFT-18	FYT 1 1/8 WM
FYT-103X	477206-103	1.1875	5.7031	4.5932	1.2812	2.200	RCJT 1 3/16	SFT-19	FYT 1 3/16 WM
FYT-104X	477207-104	1.2500	6.2969	5.1250	2.1250	3.090	RCJT 1 1/4	SFT-20	FYT 1 1/4 WM
FYT-106X	477207-106	1.3750	6.2969	5.1250	2.1250	3.090	RCJT 1 3/8	SFT-22	FYT 1 3/8 WM
FYT-107X	477207-107	1.4375	6.2969	5.1250	2.1250	3.090	RCJT 1 7/16	SFT-23	FYT 1 7/16 WM
FYT-108X	477208-108	1.5000	6.8125	5.6562	2.3125	3.600	RCJT 1 1/2	SFT-24	FYT 1 1/2 WM
FYT-110X	477209-110	1.6250	7.1562	5.8437	2.3125	4.520	RCJT 1 5/8	SFT-26	FYT 1 5/8 WM
FYT-111X	477209-111	1.6875	7.1562	5.8437	2.3125	4.520	RCJT 1 11/16	SFT-27	FYT 1 11/16 WM
FYT-112X	477209-112	1.7500	7.1562	5.8437	2.3125	4.520	RCJT 1 3/4	SFT-28	FYT 1 3/4 WM
FYT-114X	477210-114	1.8750	7.5000	6.1875	2.6250	5.620	RCJT 1 7/8	SFT-30	-
FYT-115X	477210-115	1.9375	7.5000	6.1875	2.6250	5.620	RCJT 1 15/16	SFT-31	FYT 1 15/16 WM
FYT-200X	477211-200	2.0000	8.5000	7.2500	2.9687	7.830	RCJT 2	SFT-32	FYT 2 WM
FYT-203X	477211-203	2.1875	8.5000	7.2500	2.9687	7.830	RCJT 2 3/16	SFT-35	FYT 2 3/16 WM

NOTE:

1.) Length dimension "L" may vary between manufacturers.

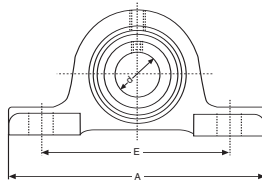

SYH...X

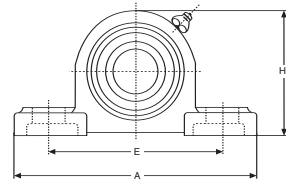
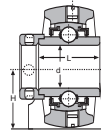

SY--

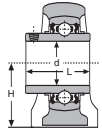

PILLOW BLOCKS - BALL BEARING UNITS WITH ECCENTRIC COLLAR

Consolidated No.	Bearing Insert No.	Dimensions (Metric / Inch)						Approx. Wgt. (lbs.)	Interchange			
		d	H	H1	E	A	L		FAF	Sealmaster (New No.)	Sealmaster (Old No.)	SKF
SYH-8X	477203-008	.5000	1.0625	2.1250	3.5000	4.7500	1.4687	1.280	RAK 1/2	NPL-8	S-508M	-
	477203-010	.6250	1.0625	2.1250	3.5000	4.7500	1.4687	1.280	RAK 5/8	NPL-10	S-510M	-
SYH-12X	477204-012	.7500	1.2500	2.5000	3.8750	5.2500	1.7187	1.960	RAK 3/4	NPL-12	S-512M	SYH 3/4 WM
SYH-14X	477205-014	.8750	1.3125	2.6875	4.1250	5.5000	1.7500	2.350	RAK 7/8	NPL-14	S-514M	SYH 7/8 WM
SYH-15X	477205-015	.9375	1.3125	2.6875	4.1250	5.5000	1.7500	2.350	RAK 15/16	NPL-15	S-515M	SYH 15/16 WM
SYH-100X	477205-100	1.0000	1.3125	2.6875	4.1250	5.5000	1.7500	2.350	RAK 1	NPL-16	S-516M	SYH 1 WM
SYH-102X	477206-102	1.1250	1.5625	3.1562	4.7500	6.3125	1.9062	3.170	RAK 1 1/8	NPL-18	S-518M	SYH 1 1/8 M
SYH-103X	477206-103	1.1875	1.5625	3.1562	4.7500	6.3125	1.9062	3.170	RAK 1 3/16	NPL-19	S-519M	SYH 1 3/16 WM
SYH-104X	477207-104	1.2500	1.8125	3.6250	5.0000	6.5625	2.0000	3.700	RAK 1 1/4	NPL-20	S-520M	SYH 1 1/4 WM
SYH-106X	477207-106	1.3750	1.8125	3.6250	5.0000	6.5625	2.0000	3.700	RAK 1 3/8	NPL-22	S-522M	SYH 1 3/8 WM
SYH-107X	477207-107	1.4375	1.8125	3.6250	5.0000	6.5625	2.0000	3.700	RAK 1 7/16	NPL-23	S-523M	SYH 1 7/16 WM
SYH-108X	477208-108	1.5000	1.9375	3.9375	5.5000	7.1250	2.2187	5.170	RAK 1 1/2	NPL-24	S-524M	SYH 1 1/2 WM
SYH-110X	477209-110	1.6250	2.0625	4.1875	5.7500	7.5000	2.2187	5.720	RAK 1 5/8	NPL-26	S-526M	SYH 1 5/8 WM
SYH-111X	477209-111	1.6875	2.0625	4.1875	5.7500	7.5000	2.2187	5.720	RAK 1 11/16	NPL-27	S-527M	SYH 1 11/16 WM
SYH-112X	477209-112	1.7500	2.0625	4.1875	5.7500	7.5000	2.2187	5.720	RAK 1 3/4	NPL-28	S-528M	SYH 1 3/4 WM
SYH-114X	477210-114	1.8750	2.1875	4.4375	6.2500	8.0000	2.4687	6.930	RAK 1 7/8	NPL-30	S-530M	-
SYH-115X	477210-115	1.9375	2.1875	4.4375	6.2500	8.0000	2.4687	6.930	RAK 1 15/16	NPL-31	S-531M	SYH 1 15/16 WM
SYH-200X	477211-200	2.0000	2.4375	4.9062	7.1250	9.1250	2.8125	8.820	RAK 2	NPL-32	S-532M	SYH 2 WM
SYH-203X	477211-203	2.1875	2.4375	4.9062	7.1250	9.1250	2.8125	8.820	RAK 2 3/16	NPL-35	S-535M	SYH 2 3/16 WM
SYH-204X	477212-204	2.2500	2.6875	5.3750	7.5000	9.5000	3.0625	11.820	RAK 2 1/4	NPL-36	S-536M	SYH 2 1/4 WM
SYH-207X	477212-207	2.4375	2.6875	5.3750	7.5000	9.5000	3.0625	11.820	RAK 2 7/16	NPL-39	S-539M	SYH 2 7/16 WM

PILLOW BLOCKS - BALL BEARING UNITS WITH SET SCREWS

SY-8	479203-008	.5000	1.1875	2.5500	3.7500	5.0000	1.2200	1.600	YAK 1/2	NP-8	-	-
	SY-10	479203-010	.6250	1.1875	2.5500	3.7500	5.0000	1.2200	1.600	YAK 5/8	NP-10	-
SY-12	479204-012	.7500	1.3125	2.5500	3.7500	5.0000	1.2200	1.500	YAK 3/4	NP-12	-	SY 3/4 TM
	SY-20 SD	479204-D	20	1.3125	2.5500	3.7500	5.0000	1.2200	1.500	YAK 20	NP-204	-
SY-14	479205-014	.8750	1.4375	2.7900	4.1250	5.5000	1.3300	2.000	YAK 7/8	NP-14	-	SY 7/8 TM
SY-15	479205-015	.9375	1.4375	2.7900	4.1250	5.5000	1.3300	2.000	YAK 15/16	NP-15	-	SY 15/16 TM
SY-25 SD	479205-D	25	1.4375	2.7900	4.1250	5.5000	1.3300	2.000	YAK 25	NP-205	-	SY 25 SD
SY-100	479205-100	1.0000	1.4375	2.7900	4.1250	5.5000	1.3300	2.000	YAK 1	NP-16	-	SY 1 TM
SY-102	479206-102	1.1250	1.6875	3.3000	4.7500	6.5000	1.5000	3.100	YAK 1 1/8	NP-18	-	SY 1 1/8 TM
SY-30 SD	479206-D	30	1.6875	3.3000	4.7500	6.5000	1.5000	3.100	YAK 30	NP-206	-	SY 30 SD
SY-103	479206-103	1.1875	1.6875	3.3000	4.7500	6.5000	1.5000	3.100	YAK 1 3/16	NP-19	-	SY 1 3/16 TM
SY-104	479207-104	1.2500	1.8750	3.6600	5.0000	6.5625	1.6800	3.900	YAK 1 1/4	NP-20	-	SY 1 1/4 TM
SY-105	479207-105	1.3125	1.8750	3.6600	5.0000	6.5625	1.6800	3.900	YAK 1 5/16	NP-21	-	SY 1 5/16 TM
SY-106	479207-106	1.3750	1.8750	3.6600	5.0000	6.5625	1.6800	3.900	YAK 1 3/8	NP-22	-	SY 1 3/8 TM
SY-35 SD	479207-D	35	1.8750	3.6600	5.0000	6.5625	1.6800	3.900	YAK 35	NP-207	-	SY 35 SD
SY-107	479207-107	1.4375	1.8750	3.6600	5.0000	6.5625	1.6800	3.900	YAK 1 7/16	NP-23	-	SY 1 7/16 TM
SY-108	479208-108	1.5000	1.9375	3.8500	5.3750	7.2500	1.9300	4.900	YAK 1 1/2	NP-24	-	SY 1 1/2 TM
SY-40 SD	479208-D	40	1.9375	3.8500	5.3750	7.2500	1.9300	4.900	YAK 40	NP-208	-	SY 40 SD
SY-110	479209-110	1.6250	2.1250	4.1700	5.7500	7.5000	1.9300	5.700	YAK 1 5/8	NP-26	-	SY 1 5/8 TM
SY-111	479209-111	1.6875	2.1250	4.1700	5.7500	7.5000	1.9300	5.700	YAK 1 11/16	NP-27	-	SY 1 11/16 TM
SY-112	479209-112	1.7500	2.1250	4.1700	5.7500	7.5000	1.9300	5.700	YAK 1 3/4	NP-28	-	SY 1 3/4 TM
SY-45 SD	479209-D	45	2.1250	4.1700	5.7500	7.5000	1.9300	5.700	YAK 45	NP-209	-	SY 45 SD
SY-115	479210-115	1.9375	2.2500	4.4800	6.2500	8.1250	2.0300	6.400	YAK 1 15/16	NP-31	-	SY 1 15/16 TM
SY-50 SD	479210-D	50	2.2500	4.4800	6.2500	8.1250	2.0300	6.400	YAK 50	NP-210	-	SY 50 SD
SY-200	479211-200	2.0000	2.5000	4.9600	6.7500	8.6250	2.1800	7.720	YAK 2	NP-32	-	SY 2 TM
SY-55 SD	479211-D	55	2.5000	4.9600	6.7500	8.6250	2.1800	7.720	YAK 55	NP-211	-	SY 55 SD
SY-203	479211-203	2.1875	2.5000	4.9600	6.7500	8.6250	2.1800	7.720	YAK 2 3/16	NP-35	-	SY 2 3/16 TM
SY-60 SD	479212-D	60	2.7500	5.3500	7.2500	9.4375	2.5600	11.500	YAK 60	NP-212	-	SY 60 SD
SY-65 SD	479213-D	65	3.0000	5.9000	8.0000	10.1250	2.6800	15.000	YAK 65	NP-213	-	SY 65 SD

NOTE:

1.) Length dimension "L" may vary between manufacturers.

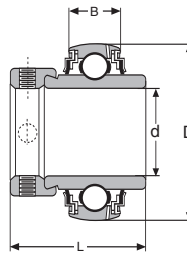

477200-...

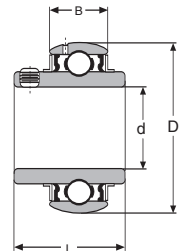

479200-...

PILLOW BLOCKS - BALL BEARING INSERTS WITH ECCENTRIC COLLAR

Consolidated No.	Dimensions (Metric / Inch)				Approx. Wgt. (lbs.)	FAF	Interchange	
	d	D	B	L			Sealmaster	SKF
477203-008	.5000	1.5748	.4724	1.4687	.330	G1008KRRB	-	-
477203-010	.6250	1.5748	.4724	1.4687	.320	G1010KRRB	-	-
477204-012	.7500	1.8504	.5512	1.7187	.450	G1012KRRB	-	YEL 204-012
477205-014	.8750	2.0472	.5906	1.7500	.590	G1014KRRB	-	YEL 205-014
477205-015	.9375	2.0472	.5906	1.7500	.550	G1015KRRB	-	YEL 205-015
477205-100	1.0000	2.0472	.5906	1.7500	.520	G1100KRRB	-	YEL 205-100
477206-102	1.1250	2.4409	.7087	1.9062	.890	G1102KRRB	-	YEL 206-102
477206-103	1.1875	2.4409	.7087	1.9062	.840	G1103KRRB	-	YEL-206-103
477207-104	1.2500	2.8346	.7480	2.0000	1.430	G1104KRRB	-	YEL 207-104
477207-106	1.3750	2.8346	.7480	2.0000	1.300	G1106KRRB	-	YEL 207-106
477207-107	1.4375	2.8346	.7480	2.0000	1.230	G1107KRRB	-	YEL 207-107
477208-108	1.5000	3.1496	.8268	2.2187	1.800	G1108KRRB	-	YEL 208-108
477209-110	1.6250	3.3465	.8661	2.2187	2.050	G1110KRRB	-	YEL 209-110
477209-111	1.6875	3.3465	.8661	2.2187	1.990	G1111KRRB	-	YEL 209-111
477209-112	1.7500	3.3465	.8661	2.2187	1.860	G1112KRRB	-	YEL 209-112
477210-114	1.8750	3.5433	.9055	2.4687	2.310	G1114KRRB	-	-
477210-115	1.9375	3.5433	.9055	2.4687	2.240	G1115KRRB	-	YEL 210-115
477211-200	2.0000	3.9375	.9843	2.8125	3.440	G1200KRRB	-	YEL 211-200
477211-203	2.1875	3.9375	.9843	2.8125	2.950	G1203KRRB	-	YEL 211-203
477212-204	2.2500	4.3307	1.0240	3.0625	4.470	G1204KRRB	-	YEL 212-204
477212-207	2.4375	4.3307	1.0240	3.0625	3.910	G1207KRRB	-	YEL 212-207

NOTE:
1.) The above inserts are for SYH...X, FY...X and FYT units.

WITH SET SCREWS

479203-008	.5000	1.5748	.6690	1.2200	.440	GY1008KRRB	2-08	-
479203-010	.6250	1.5748	.6690	1.2200	.440	GY1010KRRB	2-010	-
479204-012	.7500	1.8500	.6690	1.2200	.350	GY1012KRRB	2-012	YAR 204-012
479204 D	20	1.8500	.6690	1.2200	.350	GYE20KRRB	5204	479204 D
479205-014	.8750	2.0470	.7080	1.3380	.510	GY1014KRRB	2-014	YAR 205-014
479205-015	.9375	2.0470	.7080	1.3380	.440	GY1015KRRB	2-015	YAR 205-015
479205 D	25	2.0470	.7080	1.3380	.510	GYE25KRRB	5205	479205 D
479205-100	1.0000	2.0470	.7080	1.3380	.510	GY1100KRRB	2-1	YAR 205-100
479206-102	1.1250	2.4400	.7870	1.5000	.710	GY1102KRRB	2-12	YAR 206-102
479206 D	30	2.4400	.7870	1.5000	.710	GYE30KRRB	5206	479206 D
479206-103	1.1875	2.4400	.7870	1.5000	.710	GY1103KRRB	2-13	YAR 206-103
479207-104	1.2500	2.8340	.9050	1.6890	1.220	GY1104KRRB	2-14	YAR 207-104
479207-106	1.3750	2.8340	.9050	1.6890	1.220	GY1106KRRB	2-16	YAR 207-106
479207 D	35	2.8340	.9050	1.6890	1.220	GYE35KRRB	5207	479207 D
479207-107	1.4375	2.8340	.9050	1.6890	1.020	GY1107KRRB	2-17	YAR 207-107
479208-108	1.5000	3.1490	.9440	1.9370	1.540	GY1108KRRB	2-18	YAR 208-108
479208 D	40	3.1490	.9440	1.9370	1.540	GYE40KRRB	5208	479208-D
479209-110	1.6250	3.3460	.9640	1.9370	1.850	GY1110KRRB	2-110	YAR 209-110
479209-111	1.6875	3.3460	.9640	1.9370	1.850	GY1111KRRB	2-111	YAR 209-111
479209-112	1.7500	3.3460	.9640	1.9370	1.540	GY1112KRRB	2-112	YAR 209-112
479209 D	45	3.3460	.9640	1.9370	1.850	GYE45KRRB	5209	479209 D
479210-115	1.9375	3.5430	1.0236	2.0310	2.000	GY1115KRRB	2-115	YAR 210-115
479210 D	50	3.5430	1.0236	2.0310	2.000	GYE50KRRB	5210	479210 D
479211-200	2.0000	3.9370	1.1410	2.1880	2.650	GY1200KRRB	2-2	YAR 211-200
479211 D	55	3.9370	1.1410	2.1880	2.650	GYE55KRRB	5211	479211 D
479211-203	2.1875	3.9370	1.1410	2.1880	2.650	GY1203KRRB	2-23	YAR 211-203
479212-204	2.2500	4.3307	1.0230	2.5610	3.640	-	2-24	YAR 212-204
479212 D	60	4.3307	1.0230	2.5610	3.750	GYE60KRRB	5212	479212 D
479212-207	2.4375	4.3307	1.0230	2.5610	3.130	GY1207KRRB	2-27	YAR 212-207
479213 D	65	4.7244	1.0630	2.6890	5.600	-	-	479213 D

NOTE:
1.) The above inserts are for SY and FY units.
2.) Length dimension "L" may vary between manufacturer.

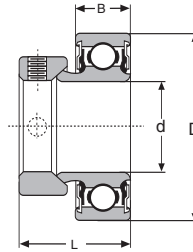

BALL BEARINGS - EXTENDED INNER RACE WITH ECCENTRIC LOCKING COLLAR AND CYLINDRICAL O.D.

Consolidated No.	Dimensions (Metric / Inch)				Approx. Wgt. (lbs.)	Interchange			
	d	D	B	L		FAF	MRC	ND	Sealmaster
RA-103-008	.5000	1.5748	.5118	1.1250	.340	RA008RR	RA-008-ATT	Z99AE008C	SL-8C
RA-103-009	.5625	1.5748	.5118	1.1250	.320	RA009RR	-	Z99AE009C	-
RA-103-010	.6250	1.5748	.5118	1.1250	.280	RA010RR	RA-010-ATT	Z99AE010C	SL-10C
RA-103	17	1.5748	.5118	1.1250	.250	RAE 17 RR	-	-	-
RA-104-012	.7500	1.8504	.5511	1.2187	.290	RA012RR	RA-012-ATT	Z99AE012C	SL-12C
RA-104	20	1.8504	.5511	1.2187	.280	RAE 20 RR	-	-	-
RA-105-013	.8125	2.0472	.5906	1.2187	.480	RA013RR	-	Z99AE013C	-
RA-105-014	.8750	2.0472	.5906	1.2187	.470	RA014RR	RA-014-ATT	Z99AE014C	SL-14C
RA-105-015	.9375	2.0472	.5906	1.2187	.440	RA015RR	RA-015-ATT	Z99AE015C	SL-15C
RA-105-100	1.0000	2.0472	.5906	1.2187	.410	RA100RR	RA-100-ATT	Z99AE100C	SL-16C
RA-105	25	2.0472	.5906	1.2187	.400	RAE 25 RR	-	-	-
RA-106-101	1.0625	2.4409	.6299	1.4062	.770	RA101RR	RA-101-ATT	Z99AE101C	-
RA-106-102	1.1250	2.4409	.6299	1.4062	.720	RA102RR	RA-102-ATT	Z99AE102C	SL-18C
RA-106-103	1.1875	2.4409	.6299	1.4062	.700	RA103RR	RA-103-ATT	Z99AE103C	SL-19C
RA-106-104	1.2500	2.4409	.6299	1.4062	.700	RA103RR2	RA-103-ATT2	Z99AE104BC	SL-20RC
RA-106	30	2.4409	.6299	1.4062	.650	RAE 30 RR	-	-	-
RA-107-104	1.2500	2.8346	.6693	1.5312	1.240	RA104RR	RA-104-ATT	Z99AE104C	SL-20C
RA-107-105	1.3125	2.8346	.6693	1.5312	1.190	RA105RR	RA-105-ATT	Z99AE105C	SL-21C
RA-107-106	1.3750	2.8346	.6693	1.5312	1.130	RA106RR	RA-106-ATT	Z99AE106C	SL-22C
RA-107-107	1.4375	2.8346	.6693	1.5312	1.090	RA107RR	RA-107-ATT	Z99AE107C	SL-23C
RA-107	35	2.8346	.6693	1.5312	1.050	RAE 35 RR	-	-	-
RA-108-108	1.5000	3.1496	.7086	1.7187	1.530	RA108RR	RA-108-ATT	Z99AE108C	SL-24C
RA-108-109	1.4375	3.1496	.7086	1.7187	1.430	RA109RR	RA-109-ATT	Z99AE109C	SL-25C
RA-108	40	3.1496	.7086	1.7187	1.400	RAE 40 RR	-	-	-
RA-109-110	1.6250	3.3465	.7480	1.7187	1.720	RA110RR	RA-110-ATT	Z99AE110C	-
RA-109-111	1.0625	3.3465	.7480	1.7187	1.620	RA111RR	RA-111-ATT	Z99AE111C	-
RA-109-112	1.7500	3.3465	.7480	1.7187	1.500	RA112RR	RA-112-ATT	Z99AE112C	-
RA-109	45	3.3465	.7480	1.7187	1.470	RAE 45 RR	-	-	-
RA-110-113	1.8125	3.5433	.7874	1.7187	1.940	RA113RR	-	Z99AE113C	-
RA-110-114	1.8750	3.5433	.7874	1.7187	1.830	RA114RR	-	Z99AE114C	-
RA-110-115	1.9375	3.5433	.7874	1.7187	1.700	RA115RR	RA-115-AZZ	Z99AE115C	-
RA-110	50	3.5433	.7874	1.7187	1.640	RAE 50 RR	-	-	-

NOTE:

1.) These bearings are not relubricable.

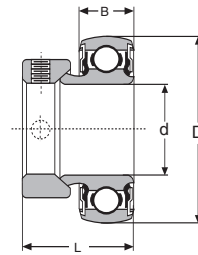

BALL BEARINGS - EXTENDED INNER RACE WITH ECCENTRIC LOCKING COLLAR AND SPHERICAL O.D.

Consolidated No.	Dimensions (Metric / Inch)				Approx. Wgt. (lbs.)	Interchange				
	d	D	B	L		FAF	MRC	ND	Sealmaster	SKF
RA-203-008	.5000	1.5748	.5118	1.1250	.340	RA008RRB	RA-008-BTT	Z99AE008	L-8C	YET 203-008
RA-203-009	.5625	1.5748	.5118	1.1250	.320	RA009RRB	-	Z99AE009	-	-
RA-203-010	.6250	1.5748	.5118	1.1250	.280	RA010RRB	RA-010-BTT	Z99AE010	L-10C	YET 203-010
RA-203	17	1.5748	.5118	1.1250	.250	RAE 17 RRB	-	-	-	*238203 D
RA-204-012	.7500	1.8504	.5511	1.2187	.290	RA012RRB	RA-012-BTT	Z99AE012	L-12C	YET 204-012
RA-204	20	1.8504	.5511	1.2187	.280	RAE 20 RRB	-	-	-	*238204D-2LS
RA-205-013	.8125	2.0472	.5906	1.2187	.480	RA013RRB	-	Z99AE013	-	YET 205-013
RA-205-014	.8750	2.0472	.5906	1.2187	.470	RA014RRB	RA-014-BTT	Z99AE014	L-14C	YET 205-014
RA-205-015	.9375	2.0472	.5906	1.2187	.440	RA015RRB	RA-015-BTT	Z99AE015	L-15C	YET 205-015
RA-205-100	1.0000	2.0472	.5906	1.2187	.410	RA100RRB	RA-100-BTT	Z99AE100	L-16C	YET 205-100
RA-205	25	2.0472	.5906	1.2187	.400	RAE 25 RRB	-	-	-	*238205D-2LS
RA-206-101	1.0625	2.4409	.6299	1.4062	.770	RA101RRB	RA-101-BTT	Z99AE101	-	YET 206-101
RA-206-102	1.1250	2.4409	.6299	1.4062	.720	RA102RRB	RA-102-BTT	Z99AE102	L-18C	YET 206-102
RA-206-103	1.1875	2.4409	.6299	1.4062	.700	RA103RRB	RA-103-BTT	Z99AE103	L-19C	YET 206-103
RA-206-104	1.2500	2.4409	.6299	1.4062	.700	RA103RRB2	RA-103-BTT2	Z99AE104B	L-20RC	YET 206-104
RA-206	30	2.4409	.6299	1.4062	.650	RAE 30 RRB	-	-	-	*238206D-2LS
RA-207-104	1.2500	2.8346	.6693	1.5312	1.240	RA104RRB	RA-104-BTT	Z99AE104	L-20C	YET 207-104
RA-207-105	1.3125	2.8346	.6693	1.5312	1.190	RA105RRB	RA-105-BTT	Z99AE105	L-21C	YET 207-105
RA-207-106	1.3750	2.8346	.6693	1.5312	1.130	RA106RRB	RA-106-BTT	Z99AE106	L-22C	YET 207-106
RA-207-107	1.4375	2.8346	.6693	1.5312	1.090	RA107RRB	RA-107-BTT	Z99AE107	L-23C	YET 207-107
RA-207	35	2.8346	.6693	1.5312	1.050	RAE 35 RRB	-	-	-	*238207D-2LS
RA-208-108	1.5000	3.1496	.7086	1.7187	1.530	RA108RRB	RA-108-BTT	Z99AE108	L-24C	YET 208-108
RA-208-109	1.4375	3.1496	.7086	1.7187	1.430	RA109RRB	RA-109-BTT	Z99AE109	L-25C	-
RA-208	40	3.1496	.7086	1.7187	1.400	RAE 40 RRB	-	-	-	*238208D-2LS
RA-209-110	1.6250	3.3465	.7480	1.7187	1.720	RA110RRB	RA-110-BTT	Z99AE110	-	YET 209-110
RA-209-111	1.0625	3.3465	.7480	1.7187	1.620	RA111RRB	RA-111-BTT	Z99AE111	-	YET 209-111
RA-209-112	1.7500	3.3465	.7480	1.7187	1.500	RA112RRB	RA-112-BTT	Z99AE112	-	YET 209-112
RA-209	45	3.3465	.7480	1.7187	1.470	RAE 45 RRB	-	-	-	*238209D-2LS
RA-210-113	1.8125	3.5433	.7874	1.7187	1.940	RA113RRB	-	Z99AE113	-	-
RA-210-114	1.8750	3.5433	.7874	1.7187	1.830	RA114RRB	-	Z99AE114	-	-
RA-210-115	1.9375	3.5433	.7874	1.7187	1.700	RA115RRB	RA115-BZZ	Z99AE115	-	YET 210-115
RA-210	50	3.5433	.7874	1.7187	1.640	RAE 50 RRB	-	-	-	*238210D-2LS

*Foreign Manufacturer.

NOTE:

- 1.) These bearings are not relubricable.
- 2.) "B" dimension may vary between manufacturers.

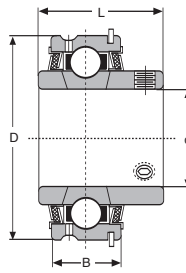

BALL BEARING - WITH SNAP RING AND EXTENDED INNER RACE WITH SET SCREWS - CYLINDRICAL O.D.

Consolidated No.	Dimensions (Metric/Inch)				Approx. Wgt. (lbs.)	Interchange			
	d	D	B	L		FAF	FED	McGill	Sealmaster
ER-8	.5000	1.8504	.6250	1.2187	.560	ER-8	WR-08	ER-8	ER-8
ER-9	.5625	1.8504	.6250	1.2187	.560	-	WR-09	ER-9	ER-9
ER-10	.6250	1.8504	.6250	1.2187	.560	ER-10	WR-10	ER-10	ER-10
ER-11	.6875	1.8504	.6250	1.2187	.560	-	WR-11	ER-11	ER-11
ER-12	.7500	1.8504	.6250	1.2187	.560	ER-12	WR-12	ER-12	ER-12
ER-204	20	1.8504	.6250	1.2187	.560	-	-	-	ER-204
ER-14	.8750	2.0472	.7500	1.3750	.680	ER-14	WR-14	ER-14	ER-14
ER-15	.9375	2.0472	.7500	1.3750	.680	ER-15	WR-15	ER-15	ER-15
ER-16	1.0000	2.0472	.7500	1.3750	.680	ER-16	WR-16	ER-16	ER-16
ER-205	25	2.0472	.7500	1.3750	.680	-	-	-	ER-205
ER-17	1.0625	2.4409	.8750	1.5000	.930	ER-17	WR-17	ER-17	ER-17
ER-18	1.1250	2.4409	.8750	1.5000	.930	-	WR-18	ER-18	ER-18
ER-19	1.1875	2.4409	.8750	1.5000	.930	ER-19	WR-19	ER-19	ER-19
ER-206	30	2.4409	.8750	1.5000	.930	-	-	-	ER-206
ER-20	1.2500	2.8346	.9375	1.6875	1.370	ER-20	WR-20	ER-20	ER-20
ER-21	1.3125	2.8346	.9375	1.6875	1.370	-	WR-21	ER-21	ER-21
ER-22	1.3750	2.8346	.9375	1.6875	1.370	ER-22	WR-22	ER-22	ER-22
ER-23	1.4375	2.8346	.9375	1.6875	1.370	ER-23	WR-23	ER-23	ER-23
ER-207	35	2.8346	.9375	1.6875	1.370	-	-	-	ER-207
ER-24	1.5000	3.1496	1.0937	1.9375	2.000	ER-24	WR-24	ER-24	ER-24
ER-25	1.5625	3.1496	1.0937	1.9375	2.000	-	WR-25	ER-25	ER-25
ER-208	40	3.1496	1.0937	1.9375	2.000	-	-	-	ER-208
ER-26	1.6250	3.3465	1.0937	1.9375	2.310	-	WR-26	ER-26	ER-26
ER-27	1.6875	3.3465	1.0937	1.9375	2.310	ER-27	WR-27	ER-27	ER-27
ER-28	1.7500	3.3465	1.0937	1.9375	2.310	ER-28	WR-28	ER-28	ER-28
ER-209	45	3.3465	1.0937	1.9375	2.310	-	-	-	ER-209
ER-30	1.8750	3.5433	1.1250	2.0312	2.430	ER-30	WR-30	ER-30	ER-30
ER-31	1.9375	3.5433	1.1250	2.0312	2.430	ER-31	WR-31	ER-31	ER-31
ER-210	50	3.5433	1.1250	2.0312	2.430	-	-	-	ER-210
ER-32	2.0000	3.9370	1.1875	2.1875	3.000	ER-32	WR-32	ER-32	ER-32
ER-34	2.1250	3.9370	1.1875	2.1875	3.000	-	WR-34	ER-34	ER-34
ER-35	2.1875	3.9370	1.1875	2.1875	3.000	ER-35	WR-35	ER-35	ER-35
ER-211	55	3.9370	1.1875	2.1875	3.000	-	-	-	ER-211
ER-36	2.2500	4.3307	1.2500	2.5625	4.000	-	WR-36	ER-36	ER-36
ER-38	2.3750	4.3307	1.2500	2.5625	4.000	-	WR-38	ER-38	ER-38
ER-39	2.4375	4.3307	1.2500	2.5625	4.000	ER-39	WR-39	ER-39	ER-39
ER-212	60	4.3307	1.2500	2.5625	4.000	-	-	-	ER-212
ER-40	2.5000	4.9213	1.3750	2.7500	5.560	-	WR-40	ER-40	ER-40
ER-43	2.6875	4.9213	1.3750	2.7500	5.560	-	WR-43	ER-43	ER-43
ER-214	70	4.9213	1.3750	2.7500	5.560	-	-	-	ER-214
ER-46	2.8750	5.1181	1.5000	3.0625	6.370	-	-	-	ER-46
ER-47	2.9375	5.1181	1.5000	3.0625	6.370	ER-47	-	-	ER-47
ER-215	75	5.1181	1.5000	3.0625	6.370	-	-	-	ER-215
ER-48	3.0000	5.5118	1.6875	3.2500	7.850	-	-	-	ER-48
ER-51	3.1875	5.5118	1.6875	3.2500	7.850	-	-	-	ER-51
ER-216	80	5.5118	1.6875	3.2500	7.850	-	-	-	ER-216
ER-52	3.2500	5.9055	1.9375	3.3750	9.500	-	-	-	ER-52
ER-54	3.3750	5.9055	1.9375	3.3750	9.500	-	-	-	ER-54
ER-55	3.4375	5.9055	1.9375	3.3750	9.500	-	-	-	ER-55
ER-63	3.9375	7.4803	2.5000	4.6250	22.000	-	-	-	ER-63
ER-64	4.0000	7.4803	2.5000	4.6250	22.000	-	-	-	ER-64

NOTE:

1.) Bearings are furnished complete with snap ring. They are dimensionally interchangeable with Sealmaster and McGill.

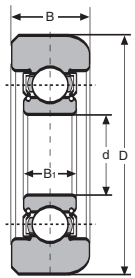

Type A

MAST GUIDE BEARINGS

Consolidated No.	Dimensions (Inch)		Dimensions (Metric)		Approx. Wgt. (lbs.)	Style No.	Interchange				
	b1	D	B	d			BCA	McGill	MRC	ND	NSK
MG 305-2RS-1	17	3.0000	1.0000	25	1.400	A	MG 305 DD	BB 849	305 SZZ3	99605 JMR 41Z8	X 421
MG 305-2RS-2	17	2.9375	1.0000	1	1.300	A	MG 305 DDA	-	305 SZZ6	-	-
MG-305-2RS-3	26	3.0000	1.0000	25	1.500	A	-	-	-	-	-
MG 306-2RS-1	19	3.5000	1.0000	30	1.900	A	MG 306 DD	-	306 SZZ5	-	X 555
MG 307-2RS-1	21	3.9900	1.1250	35	2.700	A	MG 307 FFH	BB 2005-2	307 SZZ10	99607 DTY 1Z8	X 376 RS
MG 307-2RS-2	21	3.7250	1.0000	35	2.800	A	MG 307 FFK	-	307 SZZ9	-	X 549 RS
MG 307-2RS-3	21	4.0000	1.1875	35	2.900	A	-	BB 816	307 SZZ4	99607 BTY 1ZF	-
MG 307-2RS-4	21	4.0000	1.1250	35	2.800	A	MG 307 FFA	-	307 SZZ18	-	-
MG 308-2RS-1	23	4.4860	1.2500	40	3.800	A	MG 308 FFA	BB 1747	308 SZZ5	-	-
MG 309-2RS-1	25	5.0025	1.2500	45	4.750	A	MG 309 DDA	BB 1652	309 SZZ4	-	X 501 RS
MG 309-2RS-2	27	5.0025	1.2500	45	4.950	A	-	-	309 SZZ5	-	-
MG-309-2RS-3	27	5.0015	1.2500	45	4.800	A	-	-	-	-	-

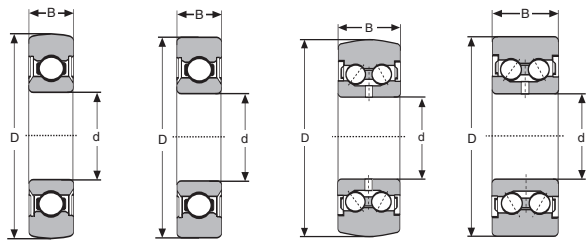

361200-2RS

361200-2RSX

305800-ZZ

305700-ZZ

YOKE TYPE TRACK ROLLERS - SINGLE ROW SEALED - CROWNED O.D.

Consolidated No.	Dimensions (Metric)			Approx. Wgt. (lbs.)	Interchange		
	d	D	B		FAG	INA	SKF
361200-2RS	10	32	9	.090	567400	LR200NPPU	361200R
361201-2RS	12	35	10	.110	567401	LR201NPPU	361201R
361202-2RS	15	40	11	.160	567402	LR202NPPU	361202R
361203-2RS	17	47	12	.240	567403	LR203NPPU	361203R
361204-2RS	20	52	14	.350	567404	LR204NPPU	361204R
361205-2RS	25	62	15	.530	567405	LR205NPPU	361205R
361206-2RS	30	72	16	.750	567406	LR206NPPU	361206R
361207-2RS	35	80	17	.950	567407	LR207NPPU	361207R
361208-2RS	40	85	18	1.000	-	LR208NPPU	361208R
361209-2RS	45	90	19	1.103	-	LR209NPPU	-

YOKE TYPE TRACK ROLLERS - SINGLE ROW SEALED - CYLINDRICAL O.D.

361200-2RSX	10	32	9	.090	-	LR200NPP	-
361201-2RSX	12	35	10	.110	-	LR201NPP	-
361202-2RSX	15	40	11	.160	-	LR202NPP	-
361203-2RSX	17	47	12	.240	-	LR203NPP	-
361204-2RSX	20	52	14	.350	-	LR204NPP	-
361205-2RSX	25	62	15	.530	-	LR205NPP	-
361206-2RSX	30	72	16	.750	-	LR206NPP	-
361207-2RSX	35	80	17	.950	-	LR207NPP	-
361208-2RSX	40	85	18	1.000	-	LR208NPP	-
361209-2RSX	45	90	19	1.103	-	LR209NPP	-

DOUBLE ROW SHIELDED - CROWNED O.D.

305800-ZZ	10	32	14	.140	542800	LR5200KDDU	305800C-2Z
305801-ZZ	12	35	15.9	.180	542801	LR5201KDDU	305801C-2Z
305802-ZZ	15	40	15.9	.240	542802	LR5202KDDU	305802C-2Z
305803-ZZ	17	47	17.5	.370	542803	LR5203KDDU	305803C-2Z
305804-ZZ	20	52	20.6	.510	542804	LR5204KDDU	305804C-2Z
305805-ZZ	25	62	20.6	.750	542805	LR5205KDDU	305805C-2Z
305806-ZZ	30	72	23.8	1.100	-	LR5206KDDU	305806C-2Z
305807-ZZ	35	80	27	1.450	-	LR5207KDDU	305807C-2Z
305808-ZZ	40	85	30.2	1.650	-	LR5208KDDU	305808C-2Z

DOUBLE ROW SHIELDED - CYLINDRICAL O.D.

305700-ZZ	10	32	14	.140	-	LR5200KDD	-
305701-ZZ	12	35	15.9	.180	542701	LR5201KDD	305701C-2Z
305702-ZZ	15	40	15.9	.240	542702	LR5202KDD	305702C-2Z
305703-ZZ	17	47	17.5	.370	542703	LR5203KDD	305703C-2Z
305704-ZZ	20	52	20.6	.510	542704	LR5204KDD	305704C-2Z
305705-ZZ	25	62	20.6	.750	542705	LR5205KDD	305705C-2Z
305706-ZZ	30	72	23.8	1.100	-	LR5206KDD	305706C-2Z
305707-ZZ	35	80	27	1.450	-	LR5207KDD	305707C-2Z
305708-ZZ	40	85	30.2	1.650	-	LR5208KDD	305708C-2Z

NOTE:

- 1.) Single row sealed yoke type track rollers are equipped with steel cages. They are lubricated with a lithium base grease - operating temperature -30° to 110°C. These bearings are not relubricable.
- 2.) Double row shielded yoke type track rollers - angular contact design - contact angle of 25°. They are equipped with two cages made from polyamide 66 material.
- 3.) Double row yoke type track rollers are lubricated with a lithium base grease - operating temperature -30° to 110°C. These bearings can be relubricated, if necessary, through a lubrication hole in the inner race.



Our Service Is...

Making our products readily available to you through a nationwide system of warehouses and sales offices. **Consolidated** is ready to fulfill your daily or long term requirements for bearings and related products. We offer the following:

Same Day Shipping Service - All orders that can be filled are shipped the same day they are received.

Emergency Shipment Service – Our staff is available to serve your requirements 24 hours a day, throughout the year including holidays. Emergency phone numbers are listed in our current price schedule.

Overseas Air Service – If stock is available, **Consolidated** will arrange airfreight shipments from our overseas suppliers. Shipments are normally delivered within 10 days.

Direct Phone Order Service – Your calls reach our order desks directly. No voice mail and no delays. WATS numbers for all warehouse locations are listed on the back page of our current price schedule.

Stock Availability Service – With our computerized inventory control system, we can provide you with an immediate answer concerning stock availability from all of our nine (9) warehouse locations. For items not available, precise delivery dates can usually be given.

Technical Service – Our engineering staff can provide you with up-to-date technical information regarding all types of bearing applications.

24-Hour Fax Service – Fax numbers for all warehouse locations are indicated on the back page of our current price schedule.

Bearing Modification Service – Our Cedar Knolls facility is equipped to modify cylindrical roller and needle bearings to various internal clearances – C/3, C/4, W/23, C/5 or custom clearances to meet your special requirements.