Rolling Bearing Damage

Recognition of damage and bearing inspection

FAG

Rolling Bearings

FAG Bearings Corporation

Publ. No. WL 82 102/2 ED

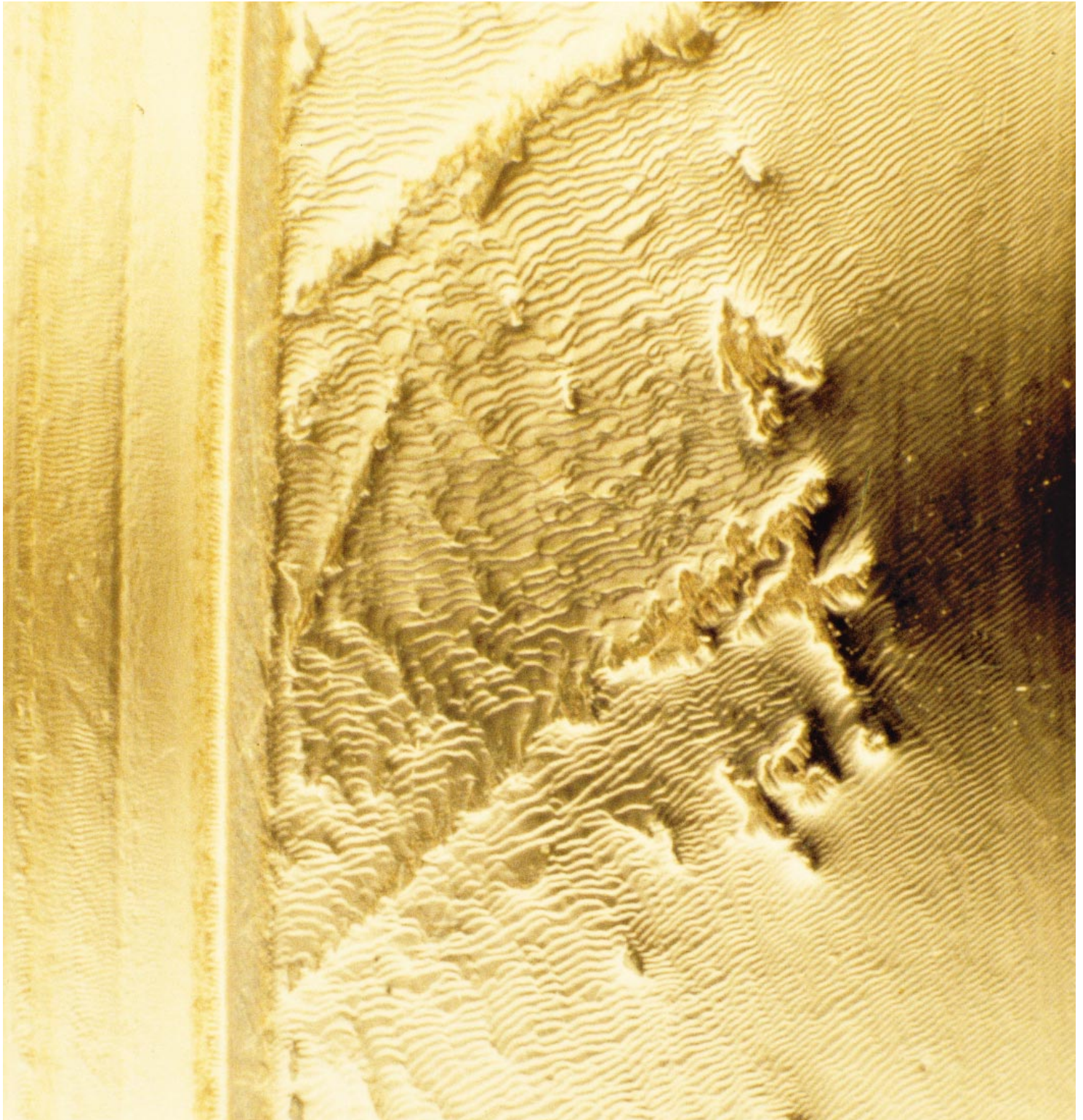

Rolling Bearing Damage

Recognition of damage and bearing
inspection

Publ. No. WL 82 102/2 ESi

FAG SOUTH EAST ASIA PTE LTD

Macpherson Road, P O Box 79

Singapore 9134

2 Kim Chuan Drive

Singapore 1953

Tel: 282 7021

Fax: 287 1780

Tlx: RS61108 fagsea

Tlgr: fagasia

Preface

Rolling bearings are machine elements found in a wide field of applications. They are reliable even under the toughest conditions and premature failure is very rare.

The first sign of rolling bearing damage is primarily unusual operating behaviour of the bearings. The examination of damaged bearings reveals a wide and varied range of phenomena. Inspection of the bearings alone is normally not enough to pinpoint the cause of damage, but rather the inspection of the mating parts, lubrication, and sealing as well as the operating and environmental conditions. A set procedure for examination facilitates the determination of the cause of failure.

This brochure is essentially a workshop manual. It provides a survey of typical bearing damage, its cause and remedial measures. Along with the examples of damage patterns the possibility of recognising the bearing damage at an early stage are also presented at the start.

Bearings which are not classified as damaged are also inspected within the scope of preventive maintenance which is frequently carried out. This brochure therefore contains examples of bearings with the running features common to the life in question.

Cover page: What may at first appear to be a photo of sand dunes taken at a high altitude is in fact the wave-shaped deformation-wear-profile of a cylindrical roller thrust bearing. There is less than just 1 micron from peak to valley. At a slow speed mixed friction occurs in the areas stressed by sliding contact. Rippling results from the stick-slip effects.

	Page		Page
1 Unusual operating behaviour indicating damage	4	3.3.4.2 Scratches on rolling element outside diameters	44
1.1 Subjective damage recognition	4	3.3.4.3 Slippage tracks	45
1.2 Bearing monitoring with technical devices	4	3.3.4.4 Score marks	46
1.2.1 Wide-spread damage	4	3.3.5 Damage due to overheating	47
1.2.2 Damage in certain spots	6	3.4 Assessment of lip contact	48
1.3 Urgency of bearing exchange – remaining life	7	3.4.1 Damage to lip and roller faces in roller bearings	48
2 Securing damaged bearings	9	3.4.1.1 Scoring due to foreign particles	48
2.1 Determination of operating data	9	3.4.1.2 Seizure in lip contact	49
2.2 Extraction and evaluation of lubricant samples	9	3.4.1.3 Wear in the lip contact area	50
2.3 Inspection of bearing environment	10	3.4.1.4 Lip fractures	51
2.4 Assessment of bearing in mounted condition	10	3.4.2 Wear of cage guiding surfaces	52
2.5 Dismounting damaged bearing	10	3.4.3 Damage to seal running areas	53
2.6 Seat check	10	3.4.3.1 Worn sealing lip tracks	53
2.7 Assessment of complete bearing	10	3.4.3.2 Discolouration of sealing track	53
2.8 Dispatch to FAG or assessment of individual parts of bearing	10	3.5 Cage damage	54
3 Evaluation of running features and damage to dismantled bearings	11	3.5.1 Wear due to starved lubrication and contamination	54
3.1 Measures to be taken	14	3.5.2 Wear due to excess speed	54
3.1.1 Marking separate parts	14	3.5.3 Wear due to roller skewing	55
3.1.2 Measurements taken with complete bearing	14	3.5.4 Wear in ball bearing cages due to tilting	55
3.1.3 Dismantling bearing into separate parts	14	3.5.5 Fracture of cage connections	56
3.1.4 Assessment of bearing parts	14	3.5.6 Cage fracture	56
3.2 The condition of the seats	15	3.5.7 Damage due to incorrect mounting	57
3.2.1 Fretting corrosion	15	3.6 Sealing damage	58
3.2.2 Seizing marks or sliding wear	16	3.6.1 Wear of sealing lips	58
3.2.3 Uneven support of bearing rings	17	3.6.2 Damage due to incorrect mounting	59
3.2.4 Lateral grazing tracks	18	4 Other means of inspection at FAG	60
3.3 Pattern of rolling contact	19	4.1 Geometric measuring of bearings and bearing parts	60
3.3.1 Source and significance of tracks	19	4.2 Lubricant analyses and lubricant inspections	63
3.3.1.1 Normal tracks	19	4.3 Material inspection	65
3.3.1.2 Unusual tracks	21	4.4 X-ray micro structure analysis	66
3.3.2 Indentations in raceways and rolling element surfaces	27	4.5 Scanning electron microscope investigations	67
3.3.2.1 Fractures	27	4.6 Component tests	69
3.3.2.2 Corrosion damage	34	4.7 Calculation of load conditions	71
3.3.2.3 False brinelling	36		
3.3.2.4 Rolling element indentations	37		
3.3.2.5 Craters and fluting due to passage of electric current	38		
3.3.2.6 Rolling element edge running	39		
3.3.3 Ring fractures	40		
3.3.3.1 Fatigue fractures as a result of raceway fatigue	40		
3.3.3.2 Axial incipient cracks and through cracks of inner rings	40		
3.3.3.3 Outer ring fractures in circumferential direction	41		
3.3.4 Deep scratches and smear marks on the contact surfaces	42		
3.3.4.1 Wear damage with poor lubrication	42		

Unusual operating behaviour indicating damage

Subjective damage recognition · Bearing monitoring with technical devices

1 Unusual operating behaviour indicating damage

Gradual deterioration of the operating behaviour is normally the first sign of bearing damage. Spontaneous damage is rare, for example that caused by mounting errors or a lack of lubrication, which leads to immediate machine downtime. Depending on the operating conditions, a few minutes, or under some circumstances even a few months, may pass from the time damage begins to the moment the bearing actually fails. The case of application in question and the effects of bearing damage on the machine operation are taken as a basis when selecting the type of bearing monitoring to be provided.

1.1 Subjective damage recognition

In the vast majority of bearing applications it is sufficient when machine operators watch out for uneven running or unusual noise in the bearing system, see table 1.

1.2 Bearing monitoring with technical devices

Bearings which could be hazardous when damaged or which could lead to long production down-times require on the other hand accurate and constant monitoring. Two examples are jet engine turbines and paper-making machines. For monitoring to be reliable, its extent must be based on the type of damage which may be expected.

1.2.1 Wide-spread damage

A sufficient supply of clean lubricant is the main precondition for trouble-free operation. Undesirable changes can be detected by:

1: Recognition of damage by operating staff

Symptoms	Sources of trouble	Examples	
Uneven running	Damaged rings or rolling elements	Motor vehicles: more and more wheel wobbling increased tilting clearance vibration of steering system	
	Contamination	Fans: growing vibration	
	Excessive bearing clearance	Saw mills: more knocks and blows in connecting rods	
Reduced working accuracy	Wear due to contaminants or insufficient lubrication	Lathe: gradual development of chatter marks on workpiece	
	Damaged rings or rolling elements	Grinders: wavy ground surface	
	Change in adjustment (clearance or preload)	Cold rolling mill: Periodic surface defects on rolled material such as stretcher strains, ghost lines etc.	
Unusual running noise: whining or squealing noise	Insufficient operating clearance		
	rumbling or irregular noise	Excessive clearance	Electric motors Gears (the bearing noise is hard to identify since it is generally drowned by the noise of the gears)
		Damaged contact areas Contamination Unsuitable lubricant	
gradual change in running noise	Change in operating clearance due to temperature Damaged running track (e.g. due to contamination or fatigue)		

Unusual operating behaviour indicating damage

Bearing monitoring with technical devices

2: March of temperature with intact main spindle bearings in a machine tool.

Test condition: $n \cdot d_m = 750\,000 \text{ min}^{-1} \cdot \text{mm}$.

3: March of temperature with disturbed floating bearings. Test condition: $n \cdot d_m = 750\,000 \text{ min}^{-1} \cdot \text{mm}$.

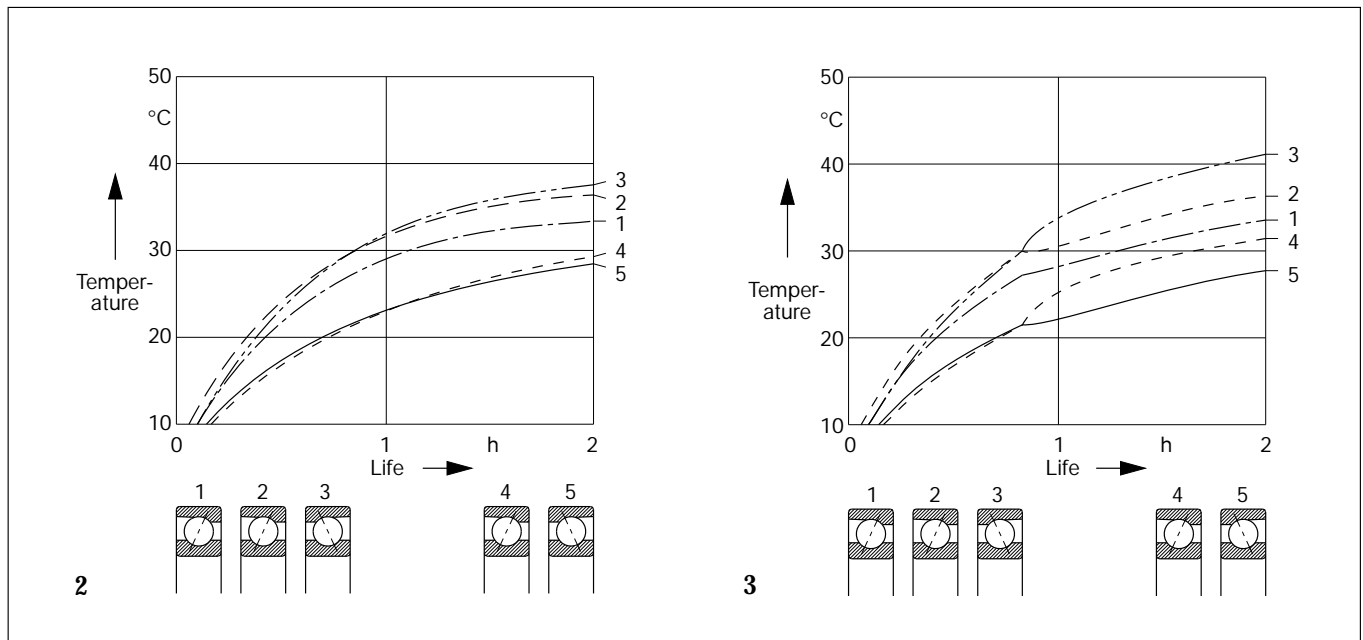

– Monitoring lubricant supply

- oil level window
- measuring oil pressure
- measuring oil flow

– Measuring abraded matter in lubricant

- at intervals
 - magnetic plug
 - spectral analysis of lubricant samples
 - inspection of oil samples in the lab
- continuously
 - magnetic signal transmitter
 - finding amount of particles flowing through with an online particle counter

– Measuring temperature

- generally with thermocouples

A very reliable and relatively easy way of recognising damage caused by inadequate lubrication is by measuring the temperature.

Normal temperature behaviour:

- reaching a steady state temperature in stationary operation, fig. 2.

Disturbed behaviour:

- sudden rise in temperature caused by lack of lubricant or by the occurrence of excessive radial or axial preload on the bearings, fig. 3.
- uneven march of temperature with maximum values tending to rise due to general deterioration of lubrication condition, e.g. with attained grease service life, fig. 4.

Measuring the temperature is not suitable, however, to register local damage at an early stage, e.g. fatigue.

4: March of temperature as a function of time with failing grease lubrication. Test condition:

$n \cdot d_m = 200\,000 \text{ min}^{-1} \cdot \text{mm}$.

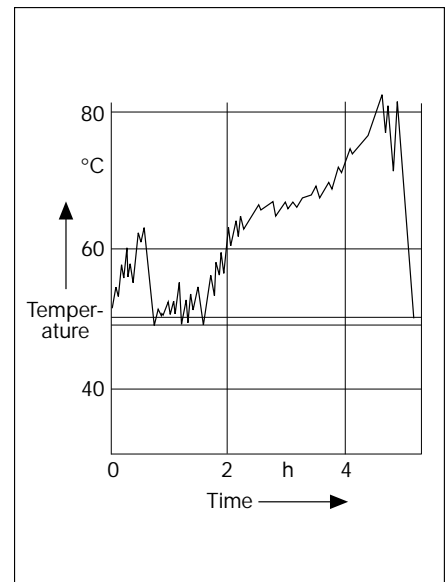

Unusual operating behaviour indicating damage

Bearing monitoring with technical devices

1.2.2 Damage in certain spots

Should bearing damage be restricted to specific locations such as indentations caused by rolling elements, standstill corrosion or fractures, it can be recognised at the earliest with vibration measurements. Shock waves which originate from the cycling of local indentations can be recorded by means of path, speed and acceleration pick-ups. These signals can be processed further at little or great expense depending on the operating conditions and the accuracy of the expected confidence factor. The most common are:

- measuring effective value
- measuring shock value
- signal analysis by envelope detection.

Experience has shown that the latter procedure is particularly reliable and practical in use. The damaged bearing components can even be pinpointed with a special type of signal processing, figs. 5 and 6. Please refer to our Publication WL 80 136 "Diagnosis of rolling bearings in machines and plants >FAG Rolling Bearing Analyser<" for more information.

6: Inner ring damage to a spherical roller bearing in a paper making machine found by means of the envelope detection procedure.

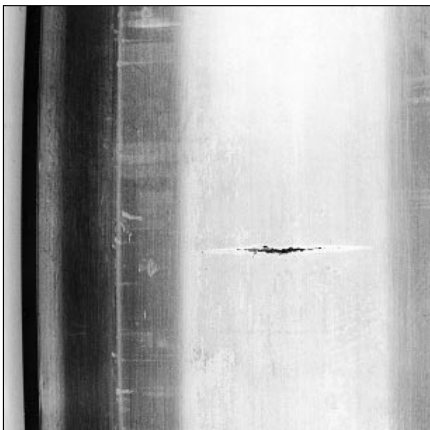

5: Frequency spectrum of envelope signal between 0 and 200 Hz, below: undamaged bearing; above: damaged bearing

n_{IR} Inner ring speed [min^{-1}]

f_{IR} Frequency of inner ring signal (cycling frequency) [Hz]

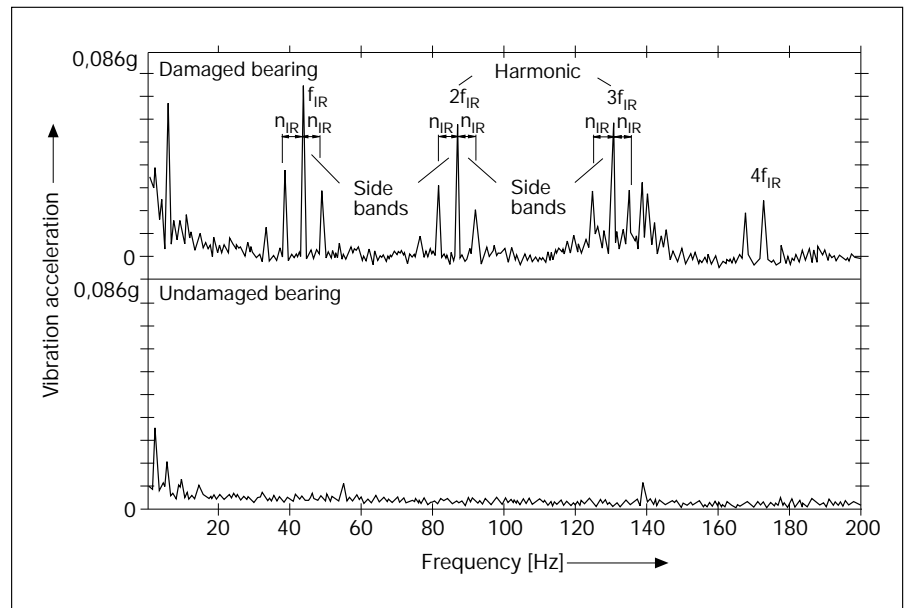

7: March of temperature and shock value as a function of time stopping lubrication. Spindle bearing B7216E.TPA; P/C = 0.1; n = 9000 min^{-1} ; Lubricating oil ISO VG100.

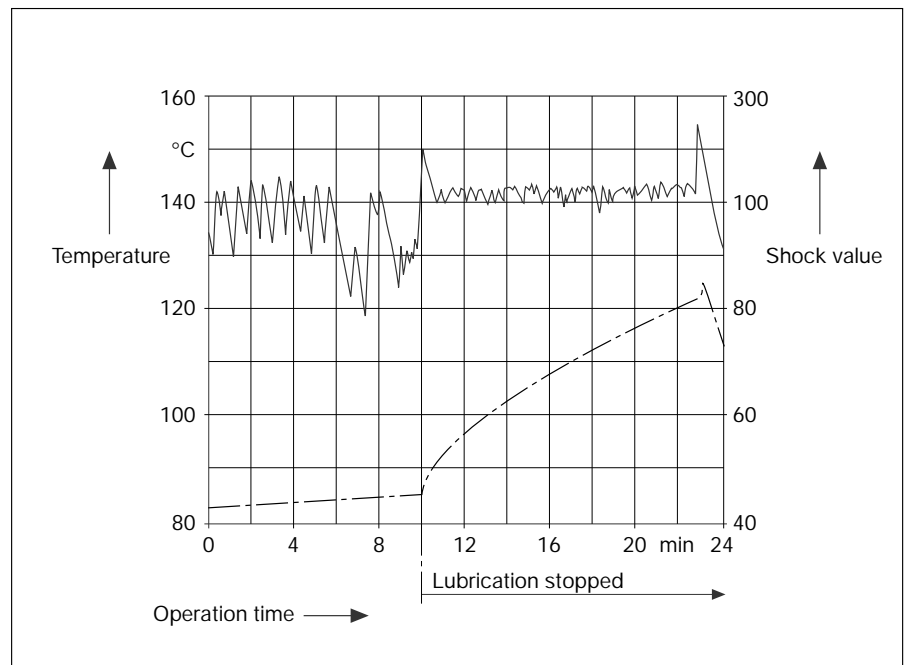

Unusual operating behaviour indicating damage

Bearing monitoring with technical devices · Urgency of bearing exchange

The vibration measuring procedures are very suitable for detecting fatigue damage. It is easiest with bearings with point contact (ball bearings) and with more sophisticated evaluation procedures such as envelope detection, for example, damage to roller bearings is found just as reliably. They are less suitable, however, for observing the lubrication condition. A fault in the lubricant supply can be reliably spotted by temperature measuring, as described above. This is particularly well illustrated in figure 7. The shock value is far less sensitive than the temperature sensor. Hence, in the case of expensive technical plants, temperature and vibration measurements complement one another ideally.

1.3 Urgency of bearing exchange – remaining life

Once bearing damage has been detected, the question arises as to whether the bearing must be exchanged immediately or whether it is possible to leave it in operation until the machine's next scheduled standstill. There are several conditions which must be given consideration before making any decision. If, for example, reduced working accuracy of a machine tool is reason to suspect bearing damage, the urgency of bearing exchange primarily depends on how long parts can continue to be produced without lacking in quality. Bearings which block suddenly at a high speed due to hot running caused by an interruption in lubricant supply going unrecognised, must be replaced immediately, of course.

In lots of cases a machine may remain in operation without the quality of the product suffering despite damage. How long it may do so depends on the bearing load, speed, lubrication, and lubri-

cant cleanliness. Extensive examinations have been made on ball bearings on the progress of damage under various loads. The main results are as follows:

8: Development of fatigue damage on the inner ring raceway of an angular contact ball bearing. The periodic intervals between inspections from damage begin on, are given in percentage of the nominal life L_{10} .

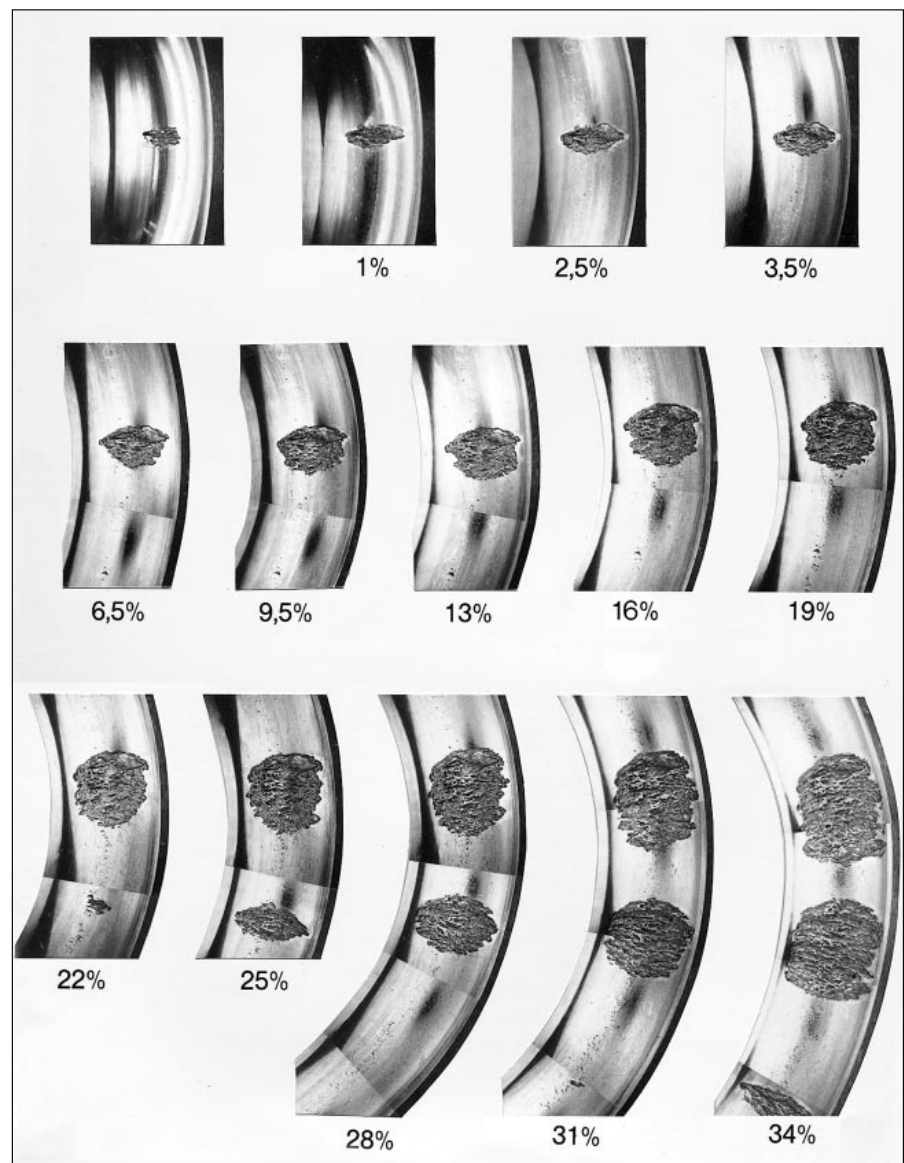

Unusual operating behaviour indicating damage

Urgency of bearing exchange

- With a moderate load, damage develops very slowly so that it is normally not necessary to replace the bearing prior to the next scheduled standstill.
- With an increasing load, damage grows far more quickly.
- The damage develops slowly first but as it becomes larger it spreads faster.

Figures 8 (page 7), 9 and 10 illustrate these findings.

9: Size of damage based on the running time after damage recognition (when approx. 0.1% of track circumference is flaked)

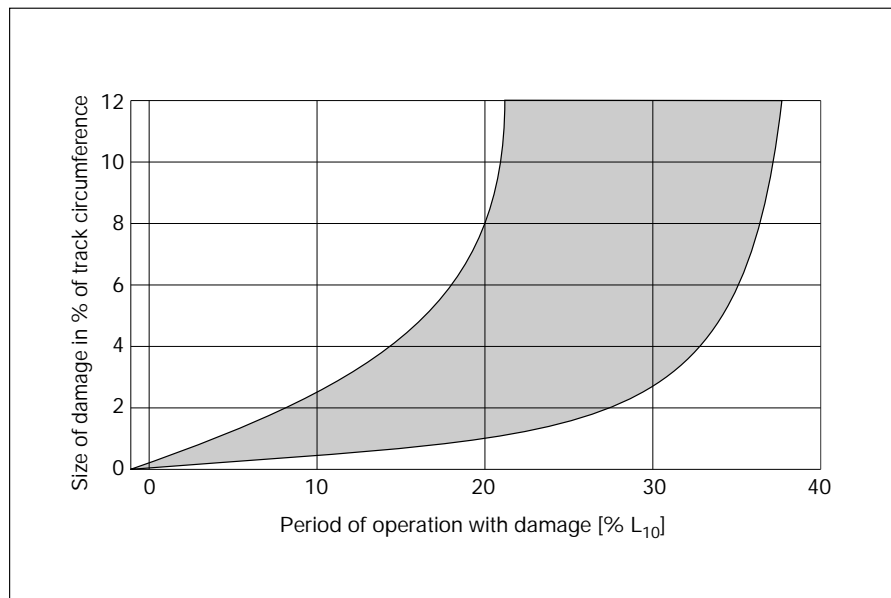

10: Mean remaining running time of angular contact ball bearings after recognition of fatigue damage based on stress condition until 1/10 of the track circumference is damaged. Operating condition prior to first signs of fatigue damage: Utmost cleanliness in EHD lubricating gap.

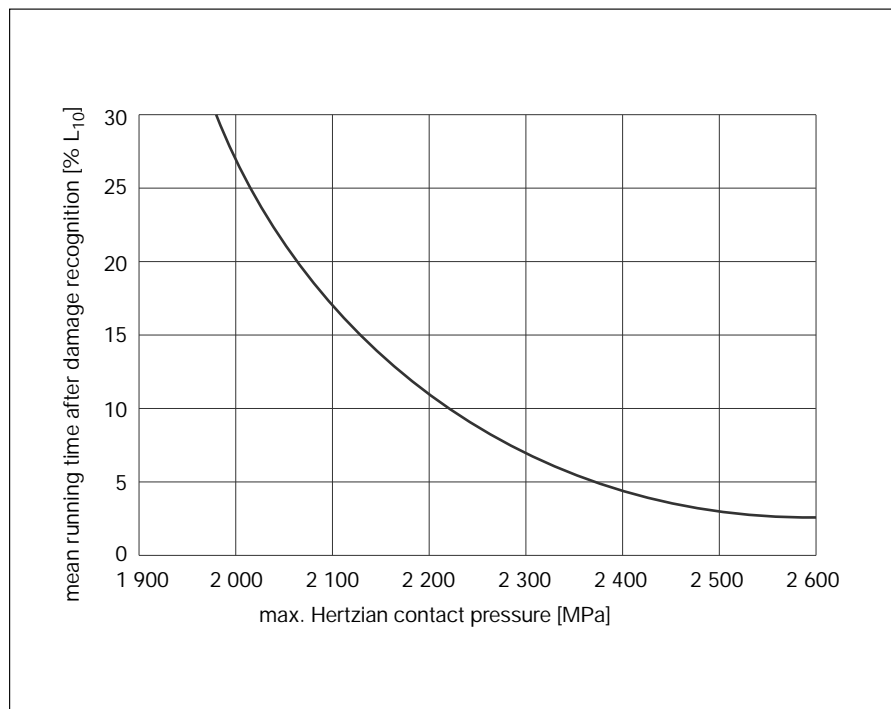

2 Securing damaged bearings

Should a bearing be removed from a machine due to damage the cause of the latter must be clarified as well as the means to avoid future failure. For the most reliable results possible it is practical to follow a systematic procedure when securing and inspecting the bearing. By the way, several of the points listed below should be given consideration when inspecting bearings dismantled during preventive maintenance.

Recommended sequence of measures:

- Determine operating data, evaluate records and charts from bearing monitoring devices
- Extract lubricant samples
- Check bearing environment for external influence and other damage
- Assessment of bearing in mounted condition
- Mark mounting position
- Dismount bearing
- Mark bearings and parts
- Check bearing seats
- Assessment of complete bearing
- Examination of individual bearing parts or dispatch to FAG

Important factors required for finding the cause of damage may be lost forever if the procedure selected is not suitable. Faults made when the damaged bearing is being secured can also disguise the damage pattern or at least make it extremely difficult to correctly explain the damage features.

2.1 Determination of operating data

Not only the bearing itself is examined when rolling bearing damage is being inspected but the environmental and application conditions are also checked in advance (with an assembly drawing if possible).

- Case of application: machine (device), bearing location, attained life, how many similar machines and how many failures in these machines
- Bearing construction: locating bearing, floating bearing floating bearing arrangement adjusted bearings (loose, rigid; with spacers, via fitting washers)
- Speed: constant, changing (inner ring and outer ring) acceleration, deceleration or retardation
- Load: axial, radial, combined, tilting moment constant, changing (collective) oscillating (acceleration, oscillation amplitude) centrifugal force point load, circumferential load (which ring is rotating?)
- Mating parts: shaft seat, housing seat (fits) fastening parts (e.g. type of locknut, elastic bolts etc.)
- Environmental conditions: external heat, cooling special media (e.g. oxygen, vacuum, radiation) vibrations in standstill dust, dirt, dampness, corrosive agents electric or magnetic fields
- Lubrication: lubricant, lubricant quantity lubricant supply relubrication interval date of last relubrication interval/last oil change
- Sealing contact, non-contact
- History of damaged bearing: first mounting or replacement bearing changes in bearing location/machine in the past failure frequency so far calculated L_{10} life

life normally attainable particularities during operational period up to now repairs on other machine parts (construction measures, welding) machine trouble due to other machine elements (e.g. seal damage, loss of oil) distance and means of transport of the machine or bearings packaging

- Evaluate records and charts from bearing monitoring devices if available

2.2 Extraction and evaluation of lubricant samples

Lubricants can reveal diverse indications of damage causes in rolling bearings. Suitable test samples are a must (only with open bearings), please refer to DIN 51750, ASTM Standard D270-65 and 4057-81.

- Grease lubrication:
 - Documentation of grease distribution and colour in the bearing environment
 - Extraction of samples from different places in the bearing and bearing environment with corresponding marking
- Oil lubrication:
 - Remove samples from the oil flow near the bearing or from the middle of the supply container
 - Extract samples during machine operation or directly after in order to obtain a typical distribution of foreign matter
 - Do not remove samples from the bottom or from directly behind filters (wrong concentration of particles)

Securing damaged bearings

- Independent of the oil samples, filter residue should also be kept for inspection (indication of history prior to damage)
- General
 - How often had the bearing been relubricated or had the oil been changed? When was either last carried out?
 - Check oil or grease for any pieces broken off the bearing or other components
 - Use clean vessels for the samples. They should be made of suitable material (glass, for example)
 - There should be enough room left in the vessel for stirring the oil sample in the laboratory
 - The analysis of the samples may take place at the customer's, in an external lubricant laboratory or at FAG. Points of interest are generally the degree of contamination and its type (sand, steel, soft little parts, water, cooling liquid) as well as an analysis of the lubricity (eg. ageing, consolidation, colour, coking, share of additives). If possible, a sample of fresh grease or oil should be handed on and examined as well (in the case of unknown lubricants, effects of heat)

2.3 Inspection of bearing environment

- Could surrounding parts have grazed against bearing parts anywhere?
- Are any other parts close to the bearing damaged (consequential or primary damage)?
- Cleanliness within and externally to seals (any foreign matter in the bearing space?)
- Loosening force of bearing fastening parts (was the bearing forced to deform? Are the bolts loose?)

2.4 Assessment of bearing in mounted condition

- Are there any ruptured or chipped areas?
- Are the seals damaged, particularly deformed or hardened?
- Is the bearing deformed at the visible areas?
- Can scratches by foreign matter be detected?
- Does the bearing run easily or tightly in mounted condition? (fit effect)

2.5 Dismounting damaged bearing

- Great care should be given not to distort the damage pattern when dismounting a damaged bearing. If this is not possible damaged caused when dismounting should be marked and noted down. The following procedure should be observed if possible:
- Do not apply dismounting force via the rolling elements
 - High dismounting force could be an indication of disturbed floating bearing function
 - Do not open sealed bearings
 - Do not destroy or damage heat-sensitive parts (lubricant, seal, cage) by heating too much
 - Mark bearing (mounting location, mounting direction)

2.6 Seat check

- Shaft and housing dimensions (detrital preload, seats too loose)
- Form tolerances of seats (oval deformation)
- Roughness of seats (excessive material loss)
- Fretting corrosion (varying degrees indicate uneven support, load direction)

2.7 Assessment of complete bearing

The bearings should always be handed over uncleaned, i.e. with lubricant remains, for assessment.

The following should be checked:

- General condition (cleanliness of bearing and condition of fitting surfaces, i.e. traces of mounting, fretting corrosion, ring fractures, dimensional accuracy, seizing marks, discolouration)
- Condition of seals and dust shields. Photograph or description of place and extent of any grease escape.
- Condition of cage
- Manual rotation test (indication of contamination, damage or preload)
- Measure bearing clearance (displaceability of rings in radial and axial direction), whereby bearings are loaded equally and rotated!

2.8 Dispatch to FAG or assessment of individual parts of bearing

The causes of failure basically possible can be detected very often by customers themselves or by an FAG employee on the site. Whether more specific examinations are required or not depends on the distinctness of each damage feature. The procedure for examining individual bearing parts is described in detail below.

If it is quite obvious that an examination is to be made at FAG the parts should be prepared for dispatch as follows:

- neither dismantle the bearing nor clean it. On no account should cold cleanser or gasoline be used for rinsing (otherwise lubrication hints disappear, corrodibility).

- Avoid contamination after dismantling. Pack the bearings separately in clean foil if possible, since paper and cloths remove oil from the grease.
- Select sufficiently strong and thick packaging to prevent damage arising during transport.

3 Evaluation of running features and damage to dismantled bearings

Bearing damage may not always imply a complete failure of a rolling bearing but also implies a reduction in the efficiency of the bearing arrangement. In this context it should be remembered that the earlier the particular bearing is dismantled the sooner the source of trouble can be detected.

A bearing arrangement can only function smoothly if the operating and environmental conditions and the components of the arrangement (bearings, mating parts, lubrication, sealing) are correctly coordinated. The cause of bearing damage does not always lie in the bearing alone. Damage which originates from bearing material and production faults is very rare. Prior to inspecting bearing damage by means of individual parts the possible damage sources should be studied based on the facts found according to Section 2. The operating

conditions or external features of the bearing frequently provide an indication of the cause of damage. The table in fig. 12 illustrates the main damage features in rolling bearings with their typical causes.

This summary cannot take all types of damage into account but just provide a rough outline. It should also be kept in mind that a number of damage patterns are exclusively or almost only found with certain types of bearings or under special application conditions. In many cases one bearing may reveal several damage features concurrently. It is then frequently difficult to determine the primary cause of failure and a systematic clarification of diverse damage hypothesis is the only answer. The systematic procedure described below is recommended for such cases.

11: Causes of failure in rolling bearings (Source: antriebstechnik 18 (1979) No. 3, 71-74). Only about 0.35% of all rolling bearings do not reach expected life.

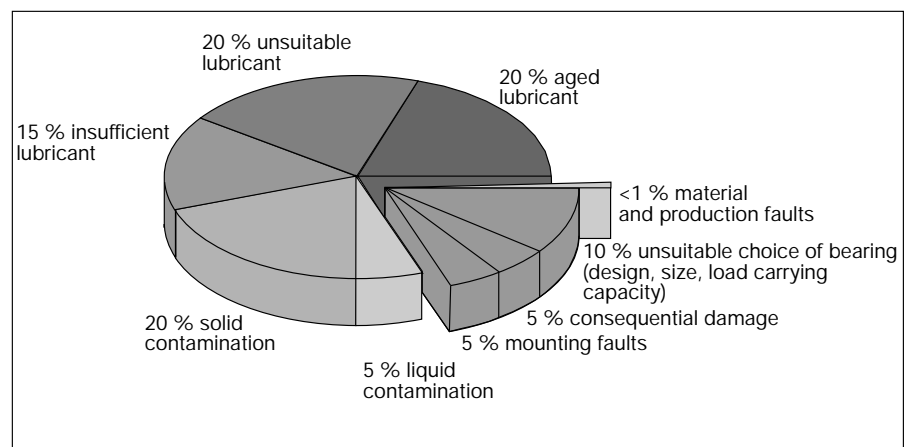

Evaluation of running features and damage to dismantled bearings

12: Rolling bearing damage symptoms and their causes

Symptom	Damaged area of bearing					Typical causes of rolling bearing damage						
	Seats	Rolling contact areas	Lip and roller face areas	Cage	Sealing	Mounting						
						Incorrect mounting procedure or tools	Dirt	Fit too tight, too much preload	Fit too loose, too little preload	Poor support of rings	Misalignment or shaft deflection	
a) Unusual running behaviour												
Uneven running						■	■		■			
Unusual noise						■	■	■	■	■	■	
Disturbed temperature behaviour								■			■	
b) Appearance of dismantled bearing parts												
1 Foreign particle indentations		■					■					
2 Fatigue		■				■	■	■		■	■	
3 Stationary vibration marks		■										
4 Molten dents and flutes		■										
5 Skidding		■							■			
6 Rolling element indentations, scuffing		■	■			■						
7 Seizing marks		■	■	■								
8 Wear		■	■	■	■		■					
9 Corrosion		■	■	■	■							
10 Overheating damage	■	■	■	■	■			■				
11 Fractures	■	■	■	■		■		■		■		
12 Fretting corrosion (false brinelling)	■								■	■		

Symptom	Typical causes of rolling bearing damage									
	Operational stress			Environmental influence				Lubrication		
	Load too high or too low	Vibrations	High speeds	Dust, dirt	Aggressive media, water	External heat	Current passage	Unsuitable lubricant	Insufficient lubricant	Excess lubricant
a) Unusual running behaviour										
Uneven running		■		■	■		■	■		
Unusual noise	■	■		■	■		■	■	■	
Disturbed temperature behaviour	■		■			■		■	■	■
b) Appearance of dis-mounted bearing parts										
1 Foreign particle indentations				■						
2 Fatigue	■			■		■		■	■	
3 Stationary vibration marks		■								
4 Molten dents and flutes							■			
5 Skidding	■								■	
6 Rolling element indentations, scuffing	■									
7 Seizing marks	■		■					■	■	
8 Wear				■				■	■	
9 Corrosion					■			■		
10 Overheating damage			■			■		■	■	■
11 Fractures										
12 Fretting corrosion (false brinelling)		■								

Evaluation of running features and damage to dismantled bearings

Measures to be taken

3.1 Measures to be taken

3.1.1 Marking separate parts

- When there are several bearings from the same type of bearing location number all bearing parts and keep a record of their arrangement in the location.
- Mark lateral arrangement of bearing parts to one another and in their mounting position.
- Mark radial mounting direction of the rings with regard to external forces.

3.1.2 Measurements taken with complete bearing

- Noise inspection
- Inspection of radial/axial clearance
- Inspection of radial/axial runout
- Inspection of frictional moment

3.1.3 Dismantling bearing into separate parts

- Determine grease quantity if grease has escaped from sealed bearings.
- Remove dust shields and seals carefully from sealed bearings avoiding deformations as much as possible.
- Assess grease distribution in the bearing.
- Take grease sample; take several samples if there is an irregular lubricant pattern.
- If dismantling cannot be non-destructive, those parts which are assumed to have had no influence on the cause of damage should be destroyed (e.g. cut or turn off the retaining lip at the small cone diameter of tapered roller bearing).
- Should damage be inevitable during the dismantling procedure it should be marked and taken note of.

3.1.4 Assessment of bearing parts

A good look at the main running and mounting features is taken first without using any devices.

A microscopic inspection of the bearing parts is recommended and often a must for the majority of bearings.

The following procedure for assessing bearing parts is usually suitable:

Assessment of:

- Seats (axial mating surfaces, inner ring bore, outer ring outside diameter)
- Raceways
- Lips
- Sealing seat surface/contact surface
- Rolling elements (outside diameter and face in the case of rollers)
- Cages
- Seals

Other inspections may also be required in order to clarify the cause of damage. These include lubricant analyses, measurements, electron micro-scopical tests, etc. In FAG's laboratories for product research and development you will find competent employees ready to assist (refer to section 4).

It must often be decided whether a bearing can be used again or whether it has to be replaced. There is no doubt about the procedure to be followed when the damage is quite obvious. Such damage, however, is seldom. The bearing assessment often provides an indication of the operating condition nevertheless. When unusual symptoms and their causes are detected extensive damage can frequently be avoided.

The following sections contain descriptions of symptoms, advice concerning their significance and cause and, where appropriate, preventive measures.

3.2 The condition of the seats

Diverse conclusions can be drawn from the condition of the seats about the supporting quality of the bearing rings on the shaft and in the housing. Ring movements against the seats cause noise which is often disturbing. They also lead to fretting corrosion and wear which in turn leads to lubricant contamination by corrosive and abrasive particles. In addition to this, the ring support continues to deteriorate and fretting corrosion can make dismantling difficult. A few examples are provided below.

3.2.1 Fretting corrosion

Symptoms:

Brownish-black spots on the seats, occasionally with brown abraded matter near bearing or in the lubricant as well. Wear at the fitting surfaces (bore, outside diameter), fatigue fracture possible in the case of rotating parts (usually the shaft), disturbance of floating bearing function possible in the case of stationary parts (usually the housing), fig. 13. With such fretting corrosion conclusions can frequently be made regarding the position and size of the load zone, fig. 14, and creeping of the rings.

Causes:

- Micromotion between fitted parts where fits are too loose in relation to the acting forces, but no creeping of rings
- Form disturbance of fitting surfaces
- Shaft deflection, housing deformation
- Floating bearing function at ring with circumferential load

Remedial measures:

- Provide floating bearing function at ring with point load
- Use bearing seats which are as tight as possible
- Make shaft (housing) more rigid to bending
- Coat bearing seats

- Use dimensionally stable rings for high operating temperatures (prevents fit loosening due to ring expansion as a result of changes in steel structure)
- Improve roundness of seats
- Check and improve, if required, the surface quality of the seats

13: Fretting corrosion in bore of a cylindrical roller bearing inner ring with seat too loose



14: Fretting corrosion reveals the size of the load zone at the stationary outer ring



Evaluation of running features and damage to dismantled bearings

Condition of seats

3.2.2 Seizing marks or sliding wear

Symptoms:

Cold welding at the fitting surfaces (inner ring bore, outer ring outside diameter) and axial mating surfaces or also shiny contact areas where surface roughness is good, figs. 15, 16.

Wear of fitting surface and face, fig. 17, perhaps reduction in preload or clearance enlargement.

Causes:

- Rotary motion between ring and shaft/housing with loose fits under circumferential load; with static load and unbalance also
- Axial support of rings insufficient
- Sluggish movement of floating bearing

Remedial measures:

- Use bearing seats which are as tight as possible
- Extend axial mating surfaces
- Secure axial support
- Keep fitting surfaces dry
- Improve floating bearing function

16: Seizing marks in the inner ring bore as a result of inner ring creeping on the shaft



15: Seizing marks on the outside diameter as a result of outer ring creeping in the housing



17: Circumferential scoring and cold welding at the inner ring faces as a result of inner ring creeping on the shaft



3.2.3 Uneven support of bearing rings

Symptoms:

Seating marks not in the area of the expected load zone.

Machining structure of fitting surfaces worn in some areas and completely untouched in others, figs. 18, 19. Later fatigue damage and fractures due to uneven load distribution and bending of rings. Lip fractures result from too little support of tapered roller bearing cones, fig. 20, and plastic setting phenomenon from contact surfaces which are too small.

Causes:

- Unsuitable design
- Inaccurate machining

Remedial measures:

- Change mating parts constructively keeping uniform housing rigidity in mind; if necessary use other bearings
- Check production of mating parts

18: Outer ring outside diameter, fretting corrosion at "tough points" (e.g. ribs) in the housing

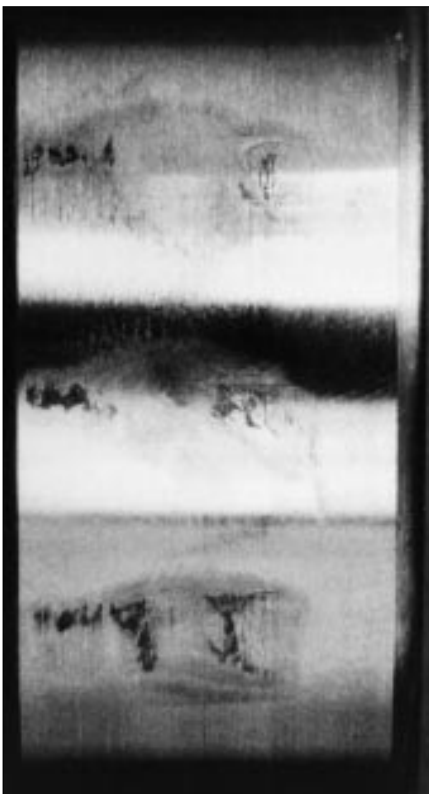

19: Outer ring outside diameter, only half its width supported

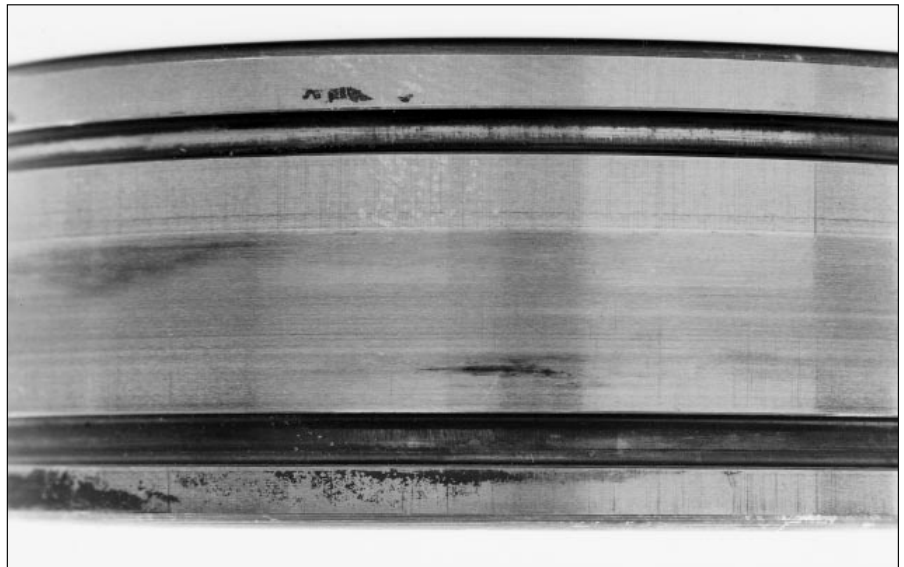

20: Lip fracture of a tapered roller bearing cone due to insufficient axial support of face



Evaluation of running features and damage to dismantled bearings

Condition of seats

3.2.4 Lateral grazing tracks

Symptoms:

Circumferential scratch marks/wear on the faces of the bearing rings or seals, figs. 21, 22.

Causes:

- Insufficient fixation of the bearings in the housing or on the shaft
- Large amount of external contamination with narrow gap between bearing and mating part
- Loose mating parts
- Axial clearance too large

Remedial measures:

- Adjust parts correctly
- Ensure lubricant cleanliness
- Check axial clearance and make it closer perhaps

21: Circumferential scoring and cold welding at the faces due to grazing by a mating part

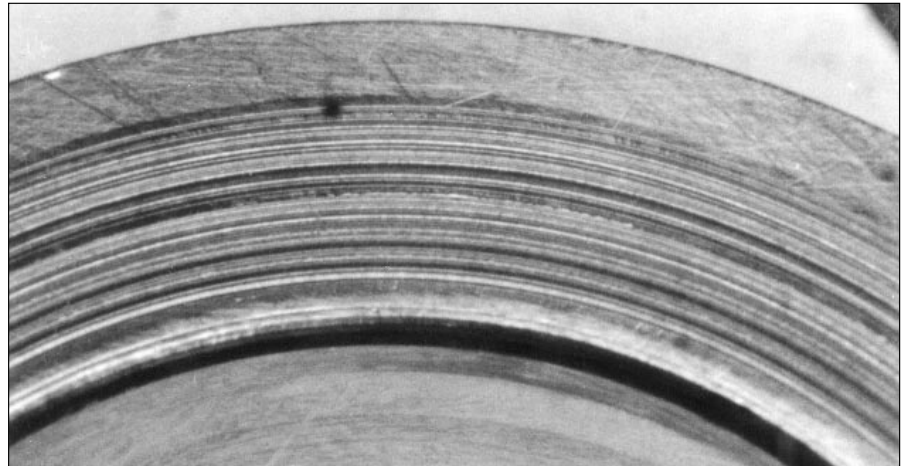

22: Seal damage due to lateral grazing



3.3 Pattern of rolling contact

3.3.1 Source and significance of tracks

Regardless of the occurrence of damage, there are changes in the contact surfaces between rings and rolling elements called tracks to be found on every bearing which has been in operation. These tracks arise from the roughening or smoothing of the surface structure originally produced. They are also characterised by indentations made by cycled foreign particles which are often microscopically small. Conclusions can therefore be drawn from the tracks about the quality of lubrication, lubricant cleanliness and the direction of load as well as its distribution in the bearing.

3.3.1.1 Normal tracks

Under rotary motion and load the rolling elements leave tracks on the raceways which are bright in appearance

when the lubricant film separates well. The individual pattern of the tracks is, however, largely dependent on the illumination of the surface but it should be possible to recognise almost all the machining structure particularly when working with a magnifying glass and microscope (compare with non-contact areas at the edge of the raceway!). Individual indentations of small foreign particles are inevitable. When lubrication is particularly good they are the only indication of the position of the load zones in the bearing, fig 23.

When temperatures are above approximately 80 °C discolouration of the raceways or rolling elements is a frequent feature. It originates from chemical reactions of the steel with the lubricant or its additives and has no negative effect on the service life of the bearing. Quite the contrary: These surface features frequently indicate effective wear protection of an additive.

Usually brown or blue colours result. However, no obvious conclusions can be drawn from the colour about the operating temperature which led to its origin. Very different shades of colour have at times been observed on the rolling elements of a bearing although the operating conditions are very similar.

This oil discolouration should on no account be confused with the tempering colours which are found on faulty bearings in rare cases and which arise as a result of much higher temperatures, see section 3.3.5.

Tracks in the form of equatorial lines are sometimes found on balls as well. They appear on angular contact ball bearings when the balls always have the same rotary axis. Any significant reduction in life does not derive from them, fig. 24.

23: Normal track, surface structure still visible, just small indentations by foreign particles



24: Ball with equatorial circumferential lines



Evaluation of running features and damage to dismantled bearings

Pattern of rolling contact

25: Radial load of a radial bearing, e.g. deep groove ball bearing. Under point load and with a sufficiently rigid housing, the track on the stationary ring is shorter than half the raceway circumference in so far as there is no radial preload. Under circumferential load, the track spreads over the entire raceway circumference.

- a: Point load for the outer ring, circumferential load for the inner ring
- b: Point load for the inner ring, circumferential load for the outer ring

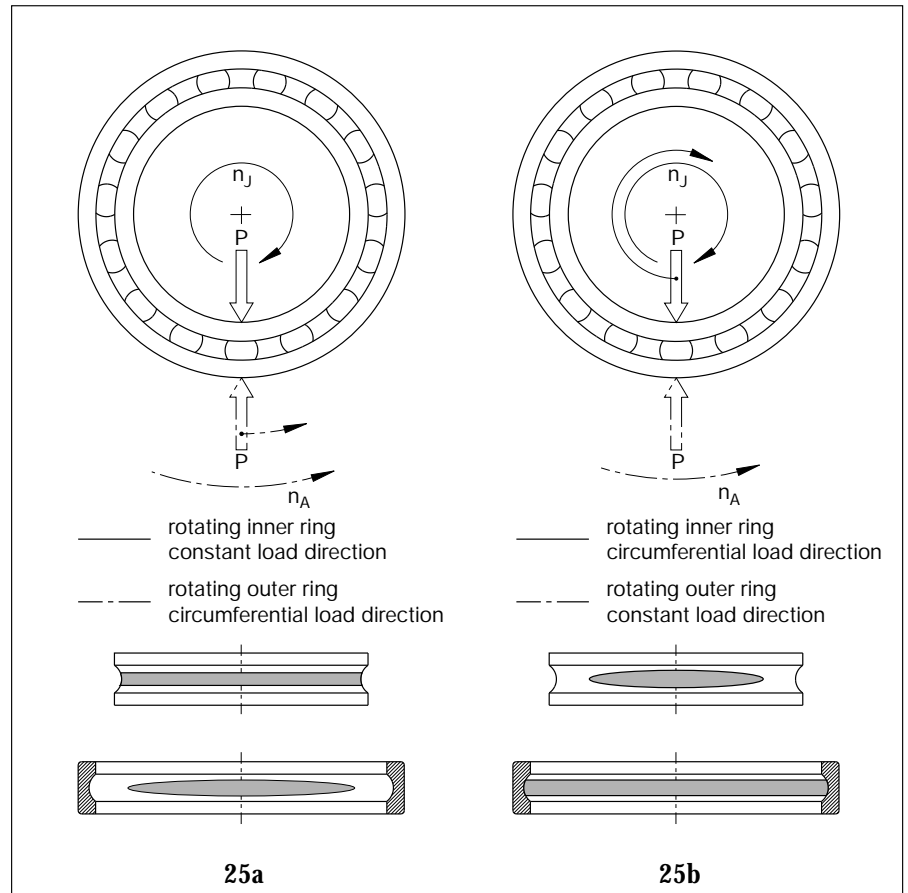

26: Axial load of a radial bearing, e.g. deep groove ball bearing. On the inner and outer rings the tracks spread off-centre over the entire raceway circumference.

27: Combined radial-axial load of a deep groove ball bearing. In the case of the inner ring (circumferential load) there is a constant wide track over the entire raceway circumference. The track on the outer ring (point load) is wider in the radial load zone than on the rest of the circumference.

The arrangement of the tracks is based on the direction of the external load and the cycling conditions (point load or circumferential load, axial load, combined load), figs. 25 to 27. A "target-actual" comparison would also reveal important information on unexpected load conditions, e.g. a disturbed floating bearing function. In the case of radial load exclusively, the origination of tracks in circumferential direction on the stationary ring depends mainly on the amount of load, the size of the bearing clearance, and the rigidity of the mating parts. The greater the load and smaller the clearance as well as the softer the housing, the longer the load zone is and thus the track also.

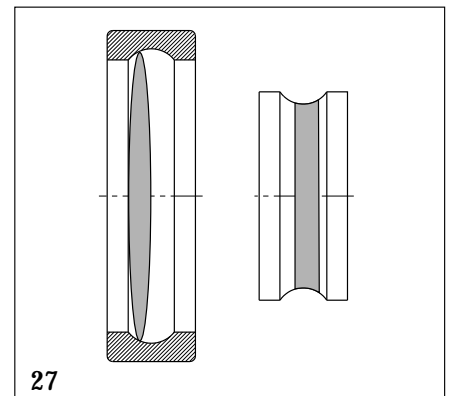
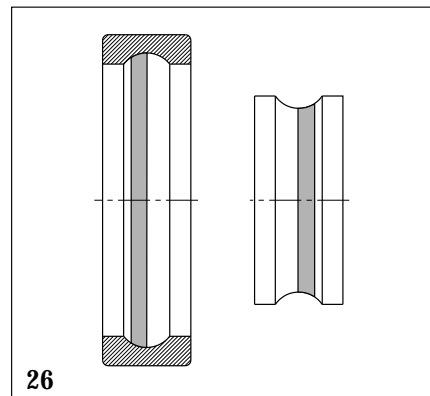

3.3.1.2 Unusual tracks

Whether tracks are considered normal or unusual depends greatly on the case of application. Bearings could have perfectly normal tracks, for example, which are an indication of mainly radial load. If, however, the bearings should be operating under axial preload, the tracks would be an indication of incorrect bearing mounting. Therefore, in order to assess the tracks correctly the conditions of application should be known. Some fundamental symptoms can, however, always be assessed by means of the tracks.

- Tracks in the case of **inadequate lubrication**

Symptoms:

The visual pattern of the tracks and the surface as observed by microscope, that is, roughness, make it possible to draw conclusions about the quality of lubrication. Dull roughened tracks arise from a non-separating lubricant film under moderate load.

The thinner the lubricant film the greater the influence on the surface. We refer to poor surface separation in this case, fig. 28.

When the specific load is high in the contact areas, the tracks are bright, pressure-polished and frequently shiny and are a clear contrast to the uncycled part of the raceways, fig. 29.

Causes:

- Insufficient lubricant quantity available in the bearing
- The viscosity of the lubricant is insufficient for the operating temperature and speed (see catalogue "FAG Rolling Bearings", adjusted rating life calculation)

Remedial measures:

- Improve lubricant supply
- Adapt lubricant viscosity to operating conditions
- Use lubricant with approved additives
- Use bearing parts with surface coating

28: Track with surface wear



29: Pressure-polished track



Evaluation of running features and damage to dismantled bearings

Pattern of rolling contact

- Tracks in the case of **contamination in bearing or lubricant**

We must first differentiate between solid and liquid contamination.

Symptoms with solid contamination:

Indentations are the result of foreign particles being cycled on the raceway. By means of the indentations, microscopic inspection of the tracks allows the differentiation between particles made of soft material, hardened steel and hard minerals, figs. 30, 31, 32. Foreign particles which are particularly large and hard are a hazard to the life. You can find more detail on this in the description of fatigue damage, please refer also to "Fatigue resulting from the cycling of foreign particles" in section 3.3.2.1. A large amount of small hard foreign particles leads to roughening as in fig. 28 and accelerates abrasive wear.

Symptoms with liquid contamination:

Water is one of the main liquid contaminants. It can be taken up by the lubricant in some small amounts. It degrades the effect of lubrication, however, and often leads to tracks like those illustrated in fig. 29. When there are large amounts of moisture in the bearing dull tracks arise. Pressure-polished tracks with fatigue damage result also from corrosion or high load, please refer to "Fatigue as a result of poor lubrication" in section 3.3.2.1.

Causes:

- Inadequate sealing
- Mounting conditions not clean
- Production residues, e.g. foundry sand
- Temperature differences (condensation of water)
- Dirty oil

Remedial measures:

- Improve sealing constructively
- Clean mounting and well washed mating parts, coat if necessary
- Rinse out entire oil system before taking into operation (before first bearing rotation!)

30: Indentations of soft foreign particles

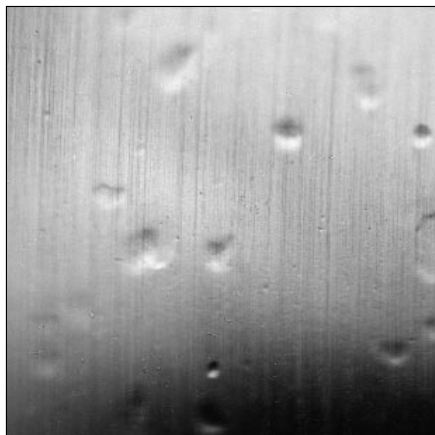

31: Indentations of foreign particles made of hardened steel

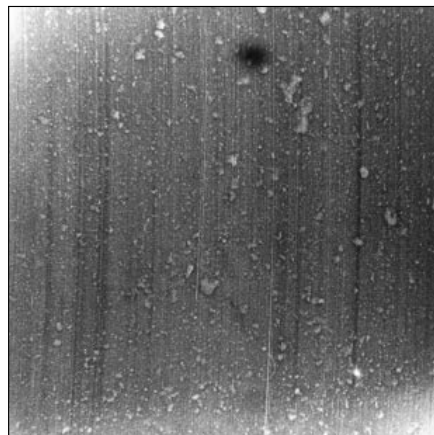

32: Indentations of hard mineral foreign particles

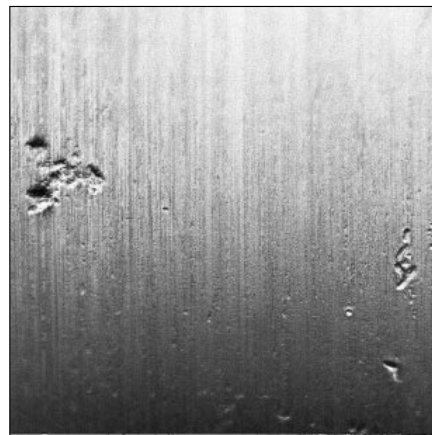

• Tracks with detrimental radial preload

Symptoms:

Circumferential tracks appear on both rings in the case of detrimental radial preload, fig. 33. Hot run damage can arise in extreme cases, section 3.3.5.

Causes:

- Fit interference at shaft/housing too large
- Temperature difference too great between inner and outer rings
- Bearing clearance too small

33: Deep groove ball bearing under detrimental radial preload. The tracks extend over the entire circumference, even on the point loaded ring.

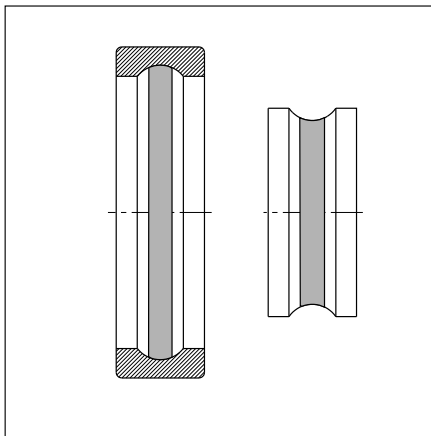

• Tracks with oval deformation

Symptoms:

Several separate track areas form on the circumference of the stationary ring, fig. 34.

Causes:

- Oval housing or shaft, e.g. due to diverse rigidity throughout the circumference during machining or due to tap holes near the bearing seats
- Different housing rigidity in circumferential direction with high interference of the outer ring
- Storing thin-walled bearings in vertical position

34: Oval deformation of a deep groove ball bearing. Two opposed radial load zones formed in the raceway of the ovaly deformed outer ring (point load).

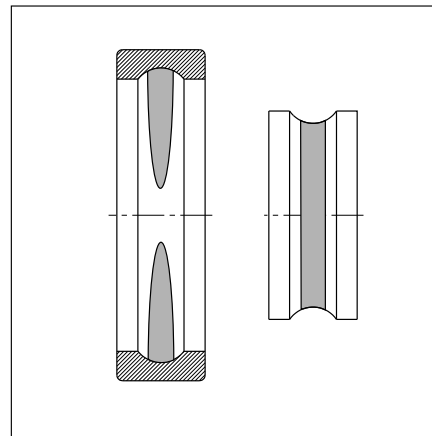

Evaluation of running features and damage to dismantled bearings

Pattern of rolling contact

- Tracks with detrimental axial preload

Symptoms:

Only the locating bearing of a locating-floating bearing arrangement may have distinctive tracks, as illustrated in fig. 35b, as they originate under axial load (fig. 26). At the most, a slight axial load share (preferably none at all) should be detected on the floating bearing.

Causes:

- Disturbed floating bearing function (wrong fit, radial-acting heat expansion, tilting, fretting corrosion)
- Unexpectedly high axial-acting heat expansion

Remedial measures:

- Check fit and form accuracy of mating parts
- Change mounting and operating conditions
- Use bearing with axial displaceability: cylindrical roller bearing N, NU, NJ

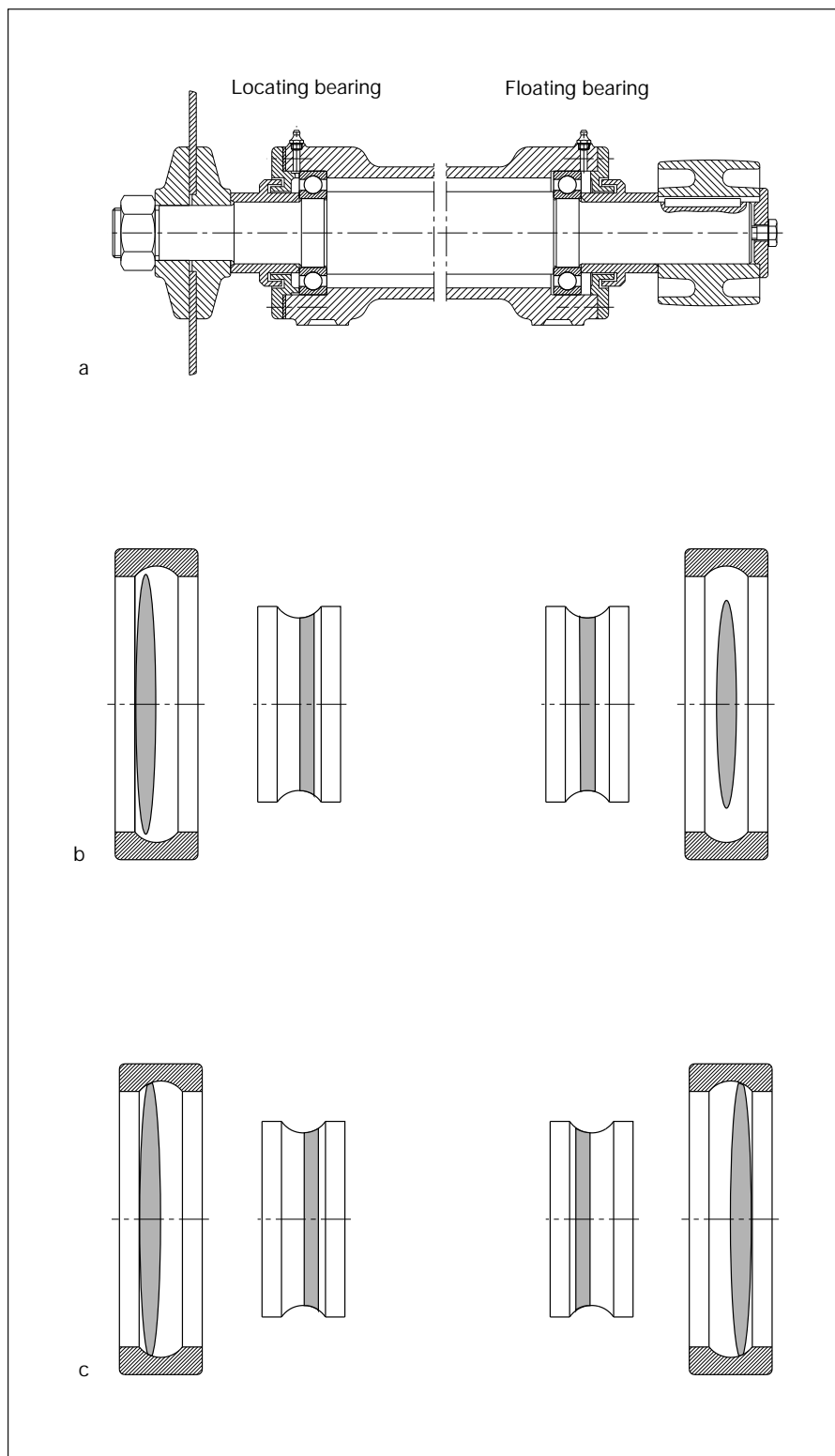

35: Locating-floating bearing arrangement with two deep groove ball bearings.

a: The deep groove ball bearing on the work end is designed as the locating bearing, the bearing on the drive end as the floating bearing.

b: Tracks on bearings in working order. The locating bearing shows the characteristics of a bearing under combined load, the floating bearing those of a bearing under mainly/purely radial load.

c: Tracks on bearings under detrimental axial preload (outer ring of floating bearing does not move). Each bearing shows the characteristics of a combined load. The detrimental axial preload is clear from the symmetric tracks of both bearings.

Evaluation of running features and damage to dismounted bearings

Pattern of rolling contact

36: Flaking in one of the tracks on the outer ring of a self-aligning ball bearing caused by detrimental axial preload



37: Development of tracks in the case of a self-aligning ball bearing with rotating inner ring under detrimental axial preload and radial load

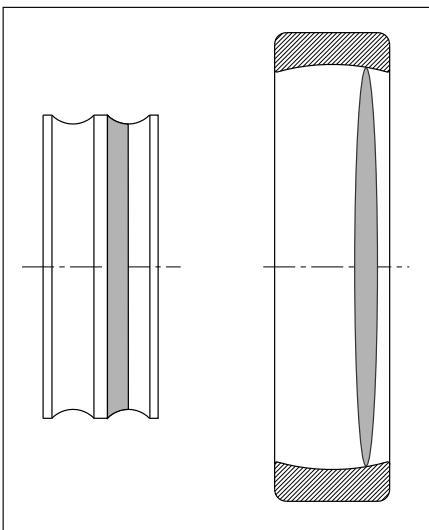

Evaluation of running features and damage to dismantled bearings

Pattern of rolling contact

• Tracks with misalignment

Symptoms:

In the case of ball bearings the track of the stationary ring does not run vertically but diagonally to the axial direction, figs. 38 and 39. With roller bearings the track is more distinct on one edge of the raceway than on the other under tilting, fig. 40.

Causes:

- Shaft deflection
- Misaligned housing halves or plummer block housings
- Out-of-square abutment surfaces
- Dirt between abutment surfaces and bearing rings during mounting
- Too much bearing clearance in combination with moment load

Remedial measures:

- Observe mounting specifications regarding permissible tilting, see FAG Catalogue
- Ensure cleanliness during mounting
- Set suitable bearing clearance

38: Misaligned bearings

a: Tilting of the inner rings relative to the outer rings in the case of misaligned housing seats

b: Tilting of the inner rings relative to each other in the case of shaft deflection

c: Tracks of a misaligned deep groove ball bearing with rotating inner ring

d: Tracks of a misaligned deep groove ball bearing with rotating outer ring

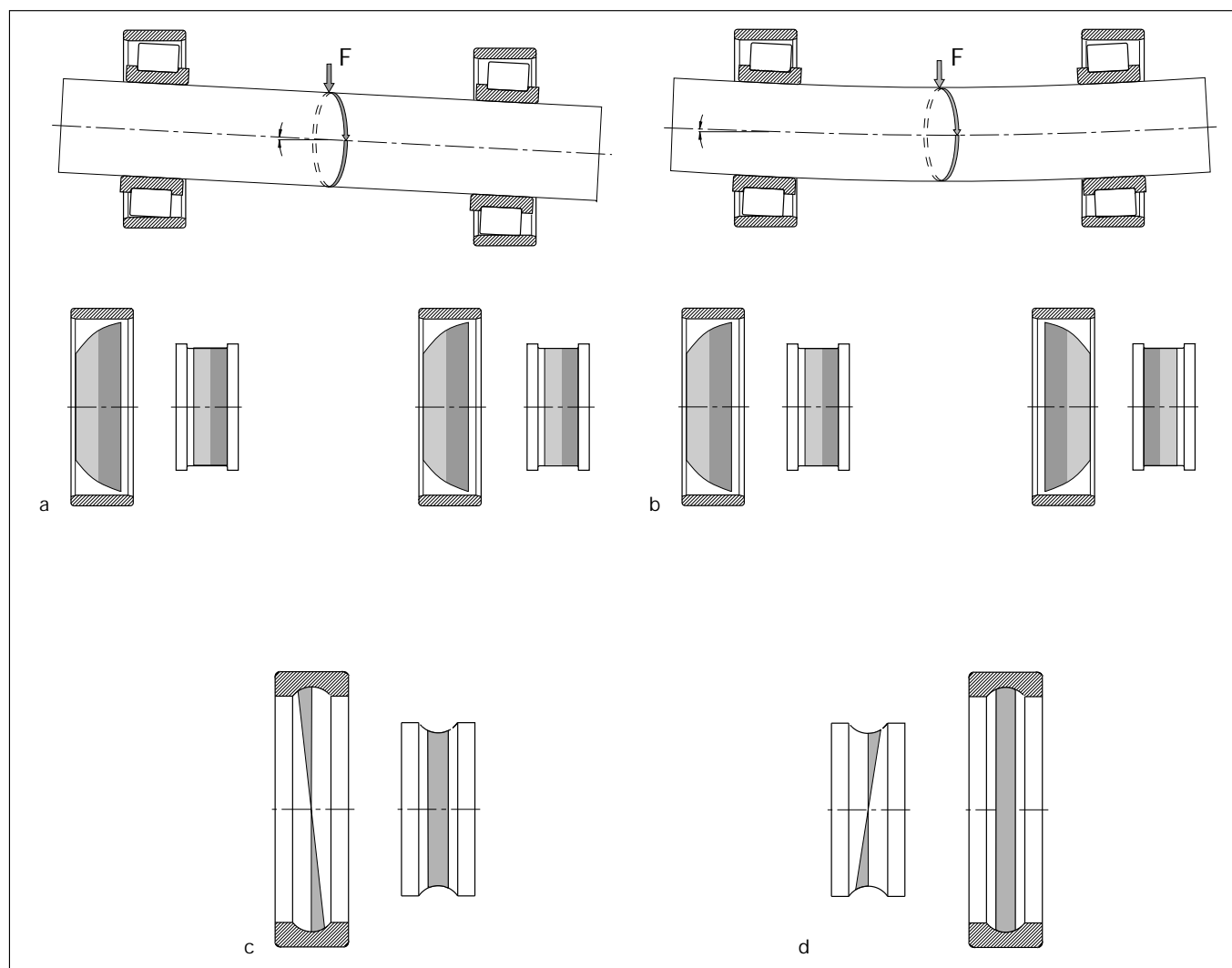

Evaluation of running features and damage to dismantled bearings

Pattern of rolling contact



39: Oblique track in inner ring of deep groove ball bearing

3.3.2 Indentations in raceways and rolling element surfaces

On damaged bearing parts indentations are often found in the contact areas which could have the most diverse causes. Since they generally occur evenly distributed in large numbers, the indentations originating from the cycling of foreign particles were taken into consideration when assessing tracks (section 3.3.1). In the subsequent paragraphs reference is made mainly to those which are locally restricted to the ring.

40: Tilted track on a tapered roller bearing



3.3.2.1 Fractures

During cycling, the material of the raceways and rolling elements is subject to a continuous pulsating stress. This leads to failure patterns like those resulting from the fatigue of mating parts under bending stress: fatigue fractures develop. In rolling bearings these fractured areas run largely parallel to the surface and lead to material flaking and are referred to as fatigue damage, flaking, pittings, spalling, grey stippiness, micro pittings, steel pittings etc.

Evaluation of running features and damage to dismantled bearings

Pattern of rolling contact

• Classical fatigue

Even with very favourable operating conditions, i.e. hydrodynamic separating lubricating film, utmost cleanliness and moderate temperatures, fatigue damage can develop on rolling bearing parts depending on the stress. Endurance strength is assumed where the index of stress is

$$f_{s^*} = C_0/P_{0^*} \geq 8$$

(C_0 = static load rating, P_{0^*} = equivalent load). When the stress is greater, which means the f_{s^*} value is smaller, fatigue damage can be expected after a more or less long operating period.

Such damage due to classical fatigue with cracks starting below the surface seldom occurs. Fatigue damage starts far more often at the surface of the components in rolling contact as a result of inadequate lubrication or cleanliness. The causes are no longer detectable when damage has advanced.

Symptoms:

Subsurface cracks of raceway and rolling elements, material flaking (relatively deep pitting), undamaged areas of the raceway indicate good lubrication in the early stage of damage, (see fig. 23), while more or less a lot of indentations by cycled fractured parts (see fig. 31) can be detected depending on how far damage has progressed, figs. 41 to 43.



41: Classical fatigue can be recognized by pitting in the raceway of a deep groove ball bearing inner ring. Material flakes off the entire raceway when damage advances.



42: Advanced fatigue damage on deep groove ball bearing

43: Fatigue damage in the outer ring raceway of a tapered roller bearing

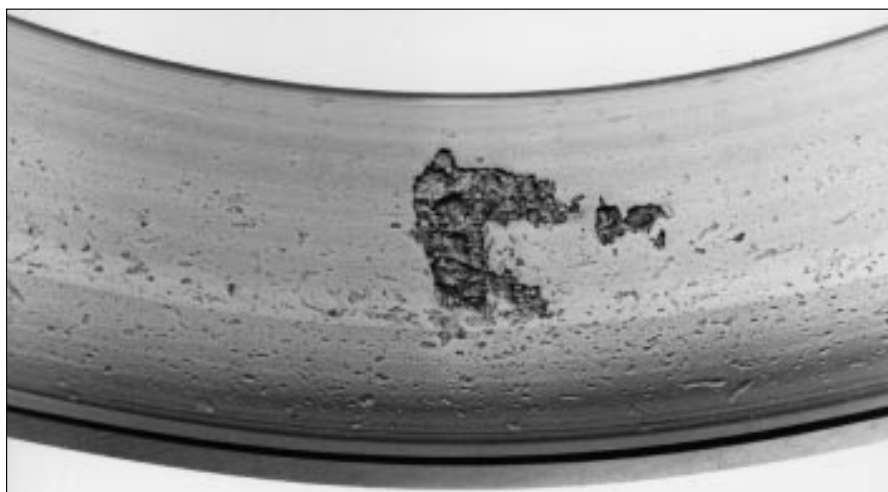

Evaluation of running features and damage to dismounted bearings

Pattern of rolling contact

• Fatigue as a result of **foreign particle cycling**

There is a great reduction in the fatigue life when rough contaminants are present in the bearing, fig. 44. The harmfulness of damage caused by foreign particles in actual cases of application depends on their hardness, size, and amount as well as the size of the bearing. With regard to fatigue ball bearings react more sensitively to contamination than roller bearings, and bearings with small rolling elements more sensitively than those with large ones. The rolled-up material plays a very important role where the indentation of foreign particles is concerned. It is particularly under stress during subsequent cycling and is responsible for the first incipient cracks, SEM fig. in section 4.

Symptoms:

Material flaking; V-shaped spreading behind the foreign particle indentation in cycling direction (V pitting), fig. 45.

Cause:

Damaged raceway, indentations by hard particles (foundry sand, grinding agent) are particularly dangerous.

Remedial measures:

- Wash housing parts thoroughly, and coat perhaps
- Cleanliness and caution required when mounting
- Improve sealing
- Use dirt-protected bearing construction
- Cleanliness of lubricant important
- Rinsing procedure with filtering prior to putting unit into operation

44: Reduction in life due to different contaminants

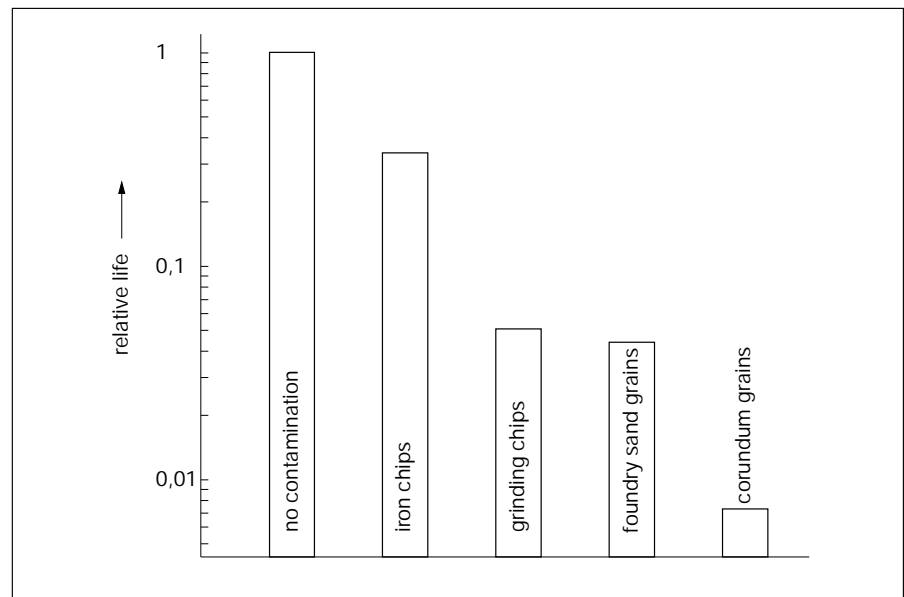

45: Fatigue damage caused by foreign particle indentation spreads itself in the cycling direction forming a V shape

a: Damage at the time of detection

b: Damage after about 1,000 operating hours

c: Damage after about 1,200 operating hours

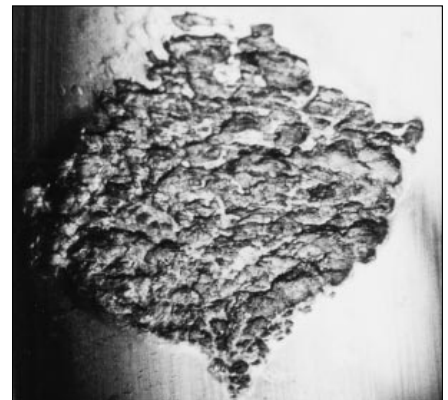

Evaluation of running features and damage to dismantled bearings

Pattern of rolling contact

• Fatigue as a result of **static overload**

Like foreign particle indentations, rolling element indentations develop due to the bearing's high static overload and their rolled-up edges lead to failure.

Symptoms:

At the early stage evenly edged indentations at rolling element spacing from which fractures arise, often only on part of the circumference.

Only on one ring sometimes. Usually asymmetric to centre of raceway.

Causes:

- Static overload, shock impact
- Mounting force applied via rolling element

Remedial measure:

- Mounting according to specification
- Avoid high impact forces, do not overload

• Fatigue as a result of **incorrect mounting**

Symptoms:

Fatigue near the small shoulder in the case of angular contact ball bearings, outside the contact angle area, fig. 46.

Causes:

- Insufficient adjustment

- Setting phenomenon of axial contact areas or in thread of clamping bolts
- Radial preload

Remedial measures:

- Rigid surrounding parts
- Correct mounting

46: Fatigue damage in groove bottom of an angular contact ball bearing's inner ring as a result of insufficient adjustment force



Evaluation of running features and damage to dismantled bearings

Pattern of rolling contact

- Fatigue as a result of **misalignment**

Symptoms:

- Track asymmetric to bearing centre, fig. 40
- Fatigue on the edges of raceway/rolling elements, fig. 47
- Circumferential notches on the entire or part of ball surface caused by plastic deformation and therefore having smooth edges. In extreme cases the bottoms of the notches may have cracks, fig. 48.

Causes:

Due to housing misalignment or shaft bending the inner ring tilts as opposed to the outer ring and high moment loads result. In ball bearings this leads to a constraining force in the cage pockets in the raceways as well as the balls running on the shoulder edge. In the case of roller bearings, the raceway is asymmetrically loaded; when tilting of the rings is extreme, the edges of the raceways and rolling elements also carry the load causing excess stress in those positions, please refer to "Tracks with misalignment" in section 3.3.1.2.

Remedial measures:

- Use self-aligning bearings
- Correct misalignment
- Strengthen shaft

47: Fatigue may occur at the edge of the raceway of a misaligned tapered roller bearing due to local overload.

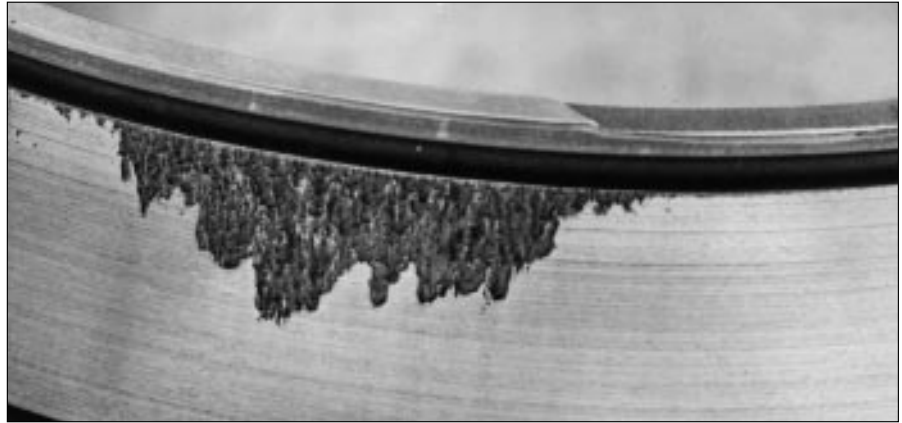

48: Fatigue at the raceway edge in the case of ball bearings, e.g. with high moment load (edge running); left raceway edge, right ball.

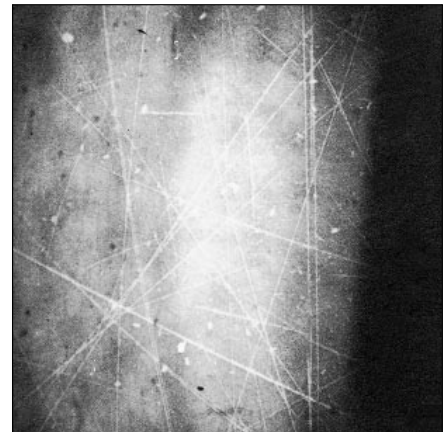

Evaluation of running features and damage to dismantled bearings

Pattern of rolling contact

- Fatigue as a result of **poor lubrication**

Symptoms:

Depending on the load, diverse damage patterns arise in the case of poor lubrication. When load is low and slippage also occurs tiny superficial fractures develop. Since they grow in large numbers, they appear like spots on the raceway, fig. 49. We refer to the terms grey stippiness or micro pittings. When the load is very high and the lubricant has, for example, thinned down due to water penetration, mussel-shaped pittings develop when the raceways (fig. 29) are also pressure polished, fig. 50.

When loads are very high and lubrication is poor very distinct heating zones develop in the raceway where, in turn, incipient cracks arise when cycling continues.

Causes:

- Poor lubrication condition as a result of
 - insufficient lubricant supply
 - operating temperature too high
 - water penetrates
- causing more friction and material stress on the raceway surface
- Slippage at times

Remedial measures:

- Increase lubricant quantity
- Use lubricant with a higher viscosity, if possible with tested EP additives
- Cool lubricant/bearing position
- Use softer grease perhaps
- Prevent penetration of water

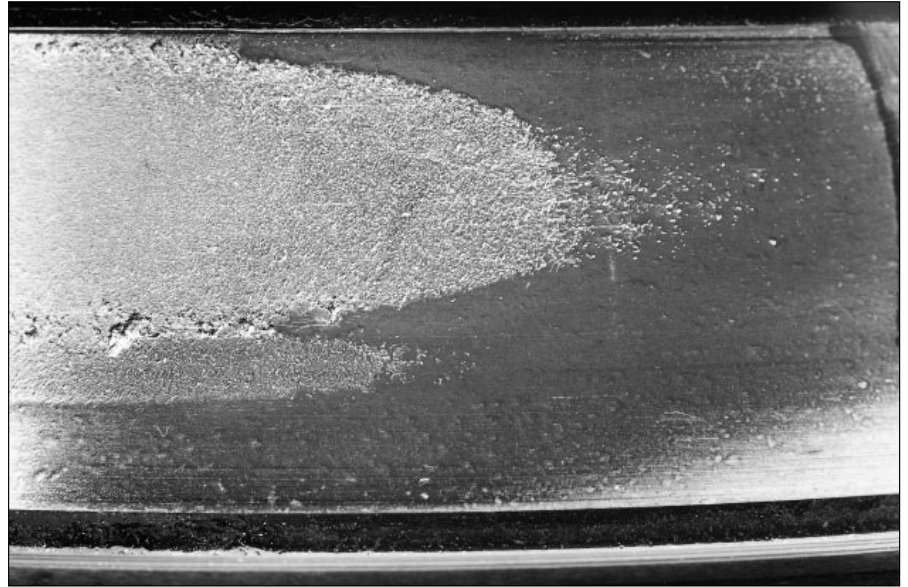

49: Micro pittings



50: Mussel-shaped fatigue

Evaluation of running features and damage to dismantled bearings

Pattern of rolling contact

• Fatigue as a result of wear

Symptoms:

Local flaking, e.g. on the rolling elements of tapered roller bearing, figs. 51 and 52. Striped track, fig. 68.

Causes:

Change in geometry of components in rolling contact due to wear in the case of contaminated lubricant, for example due to the penetration of foreign particles when sealing is damaged. Local overload results, partly in connection also with insufficient adjustment of tapered roller bearings.

Remedial measures:

- Replace lubricant on time
- Filter lubricating oil
- Improve sealing
- Replace worn seals on time
- Special heat treatment for rings and rollers

• Fatigue due to fracture in case layer

Symptoms:

Raceway peeling in thick chunks in the case of case-hardened bearing parts.

Causes:

- Fracture or separation of case layer
- Load too high or case layer thickness too thin for given load, e.g. due to wrong design load

Remedial measures:

- Adjust thickness of case layer to suit load conditions
- Avoid overloading

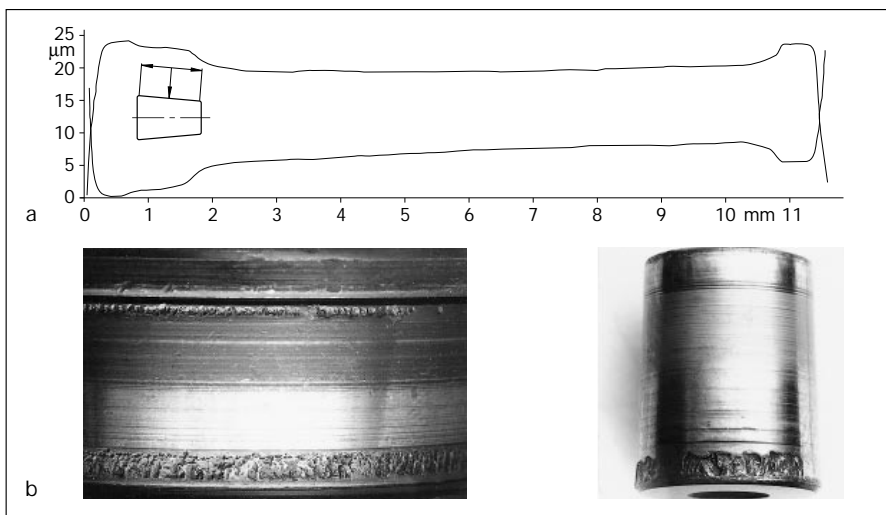

51: Wear in diverse areas can change the geometry of the components in rolling contact to such an extent that local overload leads to fatigue

a: Cross profile of a roller;

b: Inner ring raceway and roller with fatigue damage.

52: Failure mechanism as in fig. 51 but with wear of the raceway edges, cross profile of the roller see fig. 69.

Evaluation of running features and damage to dismantled bearings

Pattern of rolling contact

3.3.2.2 Corrosion damage

- Corrosion due to humidity (rust)

Symptoms:

Brownish discolouration of the complete bearing surface, usually unevenly distributed in the form of individual pits, fig. 53.

In many cases there are also spots of rust with pits at the rolling element pitch (standstill corrosion). Capillary effect causes humidity to concentrate on

the contact areas when standstill is for a long period, fig. 54. This leads to wear at a later stage and premature fatigue originating at the rust pits.

Causes:

- Incorrect storage in warehouse (relative air humidity > 60%)
- Extreme temperature variations (condensation moisture)
- Sealing failure (accelerated by the abrasive action of dirt, fig. 87)
- Unsuitable lubricant

Remedial measures:

- Suitable storage according to the specifications of rolling bearing manufacturer
- Improvement in seals (additional shields perhaps)
- Use lubricant with corrosion inhibitors
- Relubricate frequently in the case of grease lubrication, particularly prior to standstill periods



53: Corrosion of the outer ring of a deep groove ball bearing, the corrosion protection of which was destroyed by humidity

54: Corrosion pits in the raceway at rolling element pitch



Evaluation of running features and damage to dismounted bearings

Pattern of rolling contact

- Corrosion due to aggressive media

Symptoms:

Usually black etching pits, fig. 55.

Causes:

- Incorrect storage in warehouse (storage of aggressive chemicals in same area)
- Sealing failure
- Unsuitable lubricant

Remedial measures:

- Storage in accordance with rolling bearing manufacturer's specifications
- Improvement in seals
- Use lubricant with corrosion inhibitors

55: Surface damage due to attack of aggressive media. The etching pits are usually black.



Evaluation of running features and damage to dismantled bearings

Pattern of rolling contact

3.3.2.3 False brinelling

Symptoms:

Marks on the raceway surface at the rolling element pitch, figs. 56 and 57. No raised edges as opposed to marks due to incorrect mounting (see section 3.3.2.4 "Rolling element indentations"). Surfaces in the indentations frequently brown in colour (corrosion) and particularly with ball bearings badly roughened (machining structure missing). Scratches in the axial direction may also be detected with ball bearings. When the bearing rotates a little occasionally, several patches due to false brinelling arise.

Causes:

Vibrations in stationary machines which lead to micromotion in the contact areas of the components in rolling contact.

Remedial measures:

- Eliminate or absorb vibrations
- Avoid standstill of sensitive machines, leave running; use safety devices during transport which unload or preload the bearings.
- Use suitable lubricant (additives).
- Select larger radial clearance for rotating loads.

56: On the inner ring of a cylindrical roller bearing, marks due to false brinelling have developed on the raceway at rolling element pitch.

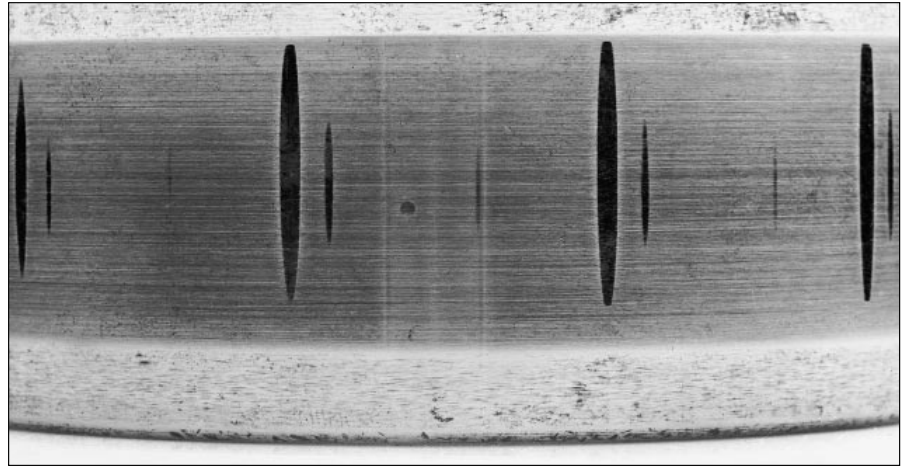

57: False brinelling on the ball bearing



Evaluation of running features and damage to dismantled bearings

Pattern of rolling contact

3.3.2.4 Rolling element indentations

Symptoms:

Indentations at the rolling element pitch in the raceways of non-separable bearings, fig. 58. Fatigue sometimes arising therefrom, see also "Fatigue as a result of static overload" in section 3.3.2.1.

The indentations may also have occurred during dismounting: check cycling features (shiny edges), determine mounting direction.

Causes:

- Static overload/shock impacts
- Mounting or dismounting forces applied via rolling elements (incorrect mounting order, unsuitable accessories)

Remedial measures:

Mount the ring with the tight fit first. When both rings have a tight fit mount them together with a suitable disk.

58: Ball indentations in the shoulders of a deep groove ball bearing. The mounting tool was attached to the ring with a loose fit and the forces were therefore applied via the balls.



Evaluation of running features and damage to dismantled bearings

Pattern of rolling contact

3.3.2.5 Craters and fluting due to passage of electric current

- Craters

Symptoms:

Craters in the raceway due to local melting at the contact area of the parts in rolling contact, sometimes several craters in a row or whole chains around the circumference. The surface in the craters is partly formed like welding beads, fig. 59.

Causes:

Sparking over current, for example during welding or due to earth contact failure

Remedial measures:

Do not direct current through the bearing during electro welding (earthing).

- Fluting

Symptoms:

Brownish marks parallel to the axis on a large part of the raceway or covering the entire raceway circumference, fig. 60.

Causes:

Constant passage of alternating or direct current, even low currents cause marks.

Remedial measures:

- Prevent currents from flowing through the bearing (earthing, insulation).
- Use current insulated bearings.

59: Current sparkover led to the formation of craters in the raceway of a cylindrical roller bearing.



60: Fluting in the outer ring raceway of a deep groove ball bearing was caused by the constant passage of current.



Evaluation of running features and damage to dismounted bearings

Pattern of rolling contact

3.3.2.6 Rolling element edge running

Symptoms:

In the case of balls, arch-shaped notches on the surface or what one could describe as "woolen balls" of notches, edges rounded since they are plastically deformed, figs. 61, 62. Circumferential notches near the faces in the case of rollers. Not to be confused with scratches by foreign particles, see section 3.3.4.2 "Scratches on rolling element outside diameters".

Causes:

- Excessive (axial) load
- Moment load too high
- Operating clearance too large
- Tilting

Remedial measures:

- Avoid overloading
- Use bearing with higher load carrying capacity
- Reduce operating clearance
- Avoid tilting

61: Ball with extreme edge tracks caused by long-term constant load



62: Ball with "woolen balls" of notches caused by long-term changing load

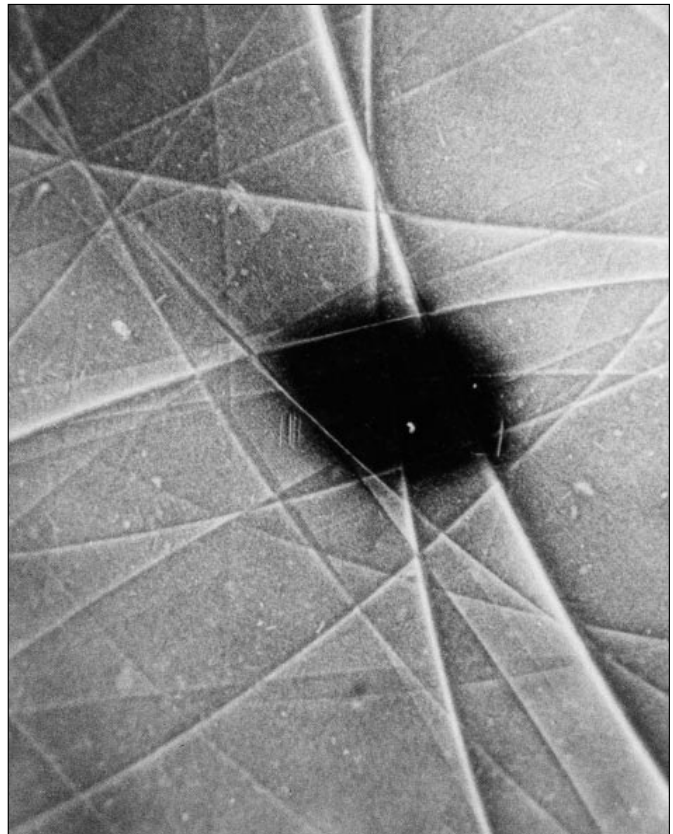

Evaluation of running features and damage to dismantled bearings

Pattern of rolling contact

3.3.3 Ring fractures

3.3.3.1 Fatigue fractures as a result of raceway fatigue

Symptoms:

Generally large-area fatigue damage in the raceway; frequently steps (lines of rest) in the fracture area, fig.63

Causes:

Well-advanced fatigue damage

Remedial measures:

See section 3.3.2.1 "Fractures"

63: Outer ring fracture of a deep groove ball bearing in the axial direction as a result of fatigue

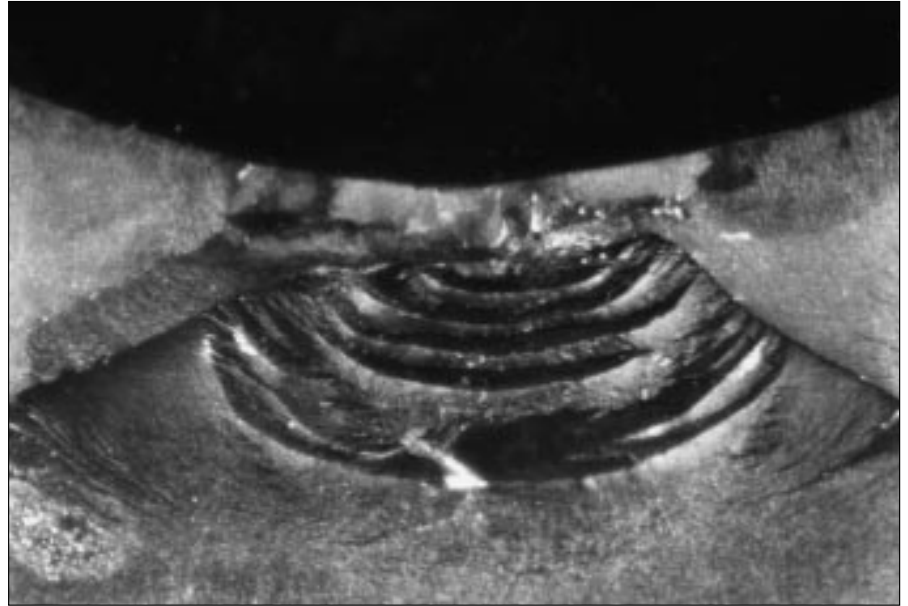

3.3.3.2 Axial incipient cracks and through cracks of inner rings

Symptoms:

Ring partly or completely cracked in the axial direction. Fractured edges slightly rounded: indicates that the fracture originated during operation and was cycled. Sharp-edged crack flanks indicate that fracture occurred during dismounting. In the case of long periods of operation with cracks, the latter's edges may be partly broken off, fig. 64.

Causes:

- Bearing slippage
- Fractures in the raceway
- Rotation of inner ring on the shaft
- Unsuitable lubrication
- Fit too tight on the shaft
- Shaft groove
- Out-of-roundness
- Grazing against surrounding parts

Remedial measures:

- Improve lubrication (additives, increase oil quantity)
- Find remedial measure for damage to raceway
- Select suitable fit
- Avoid grazing of surrounding parts
- Provide for better seating conditions
- Special heat treatment for rings

64: Axial through crack of a spherical roller bearing's inner ring



3.3.3.3 Outer ring fractures in circumferential direction

Symptoms:

Usually the crack spreads evenly in the circumferential direction. Several fractured pieces often originate. With axial load, these fractures occur as a rule a little beyond the middle of the raceway. Fatigue damage is often the cause. The outer ring outside surface normally

shows an irregular load carrying pattern, fig. 65.

Causes:

Poor support of the rings in the housing

Remedial measures:

Constructive improvement in mounting required

65: Crack in outer ring in circumferential direction



Evaluation of running features and damage to dismantled bearings

Pattern of rolling contact

3.3.4 Deep scratches and smear marks on the contact surfaces

In addition to local fractures, cracks, and other dents in the raceway or rolling element surfaces, large-area surface damage also frequently arises as a result of sliding in the bearing which leads to wear. In addition to the cycling conditions, the extent of this damage is essentially influenced by the intensity and cleanliness of the lubrication.

3.3.4.1 Wear damage with poor lubrication

Symptoms:

The contact areas are dull and roughened, figs. 28 and 66. Abraded matter turns the lubricant dark in colour; also yellow in the case of brass cages. The grease is also solidified. In many cases, however, moisture leads to the lubricant consistency growing watery. Either preload is reduced or the bearing clearance is enlarged. If foreign particles are the cause of wear, the rolling element surfaces will be particularly badly scored, fig. 67. Under adverse conditions, roller bearing raceways may be unevenly worn throughout their circumference. The appearance of the raceways is then stripy, fig. 68 and 69. This type of wear leads to fatigue damage, please refer to "Fatigue as a result of wear" in section 3.3.2.1.

Causes:

- Non-load-carrying lubricant film
- Contaminants in lubricant (fine, hard particles, e.g. dust, or also water)
- Insufficient adjustment of bearings in the case of uneven wear of tapered roller bearings

66: Worn, roughened raceway



67: Wear traces can usually first be detected on the surfaces of the rolling elements

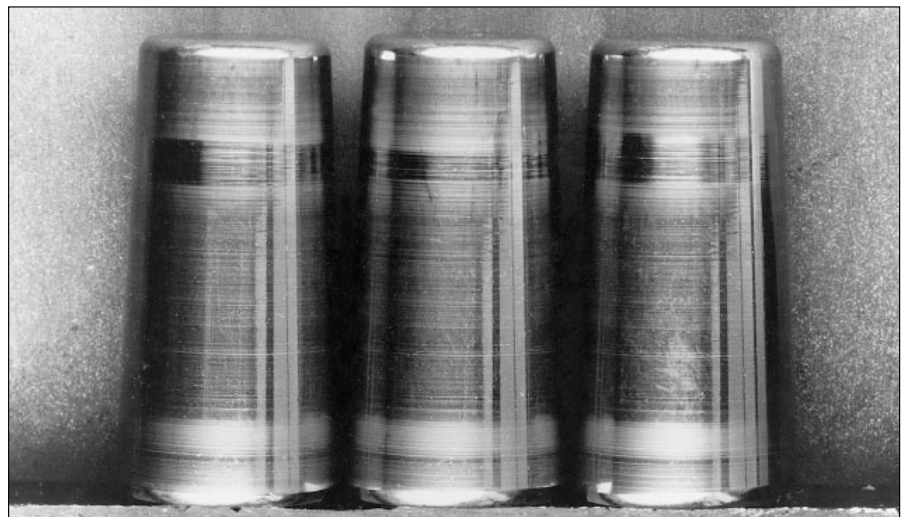

Evaluation of running features and damage to dismantled bearings

Pattern of rolling contact

Remedial measures:

- Use lubricant with higher load carrying capacity, e.g. with more viscosity or EP additives
- Shorten lubricant change intervals
- Improve sealing
- Filter lubricant
- Ensure correct adjustment of bearings

68: Formation of stripes as a result of wear in certain areas.
a: Roller

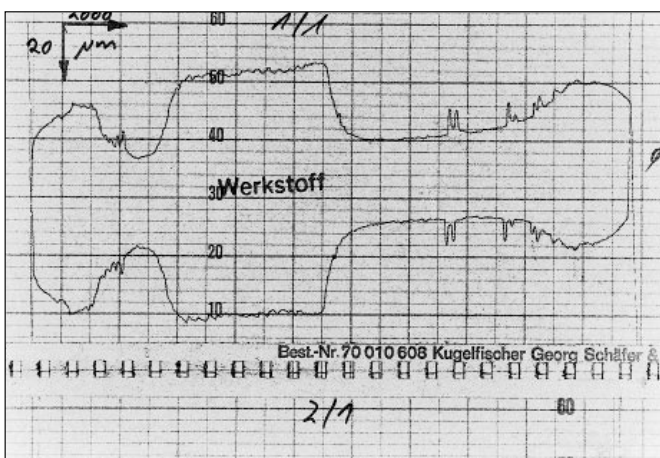
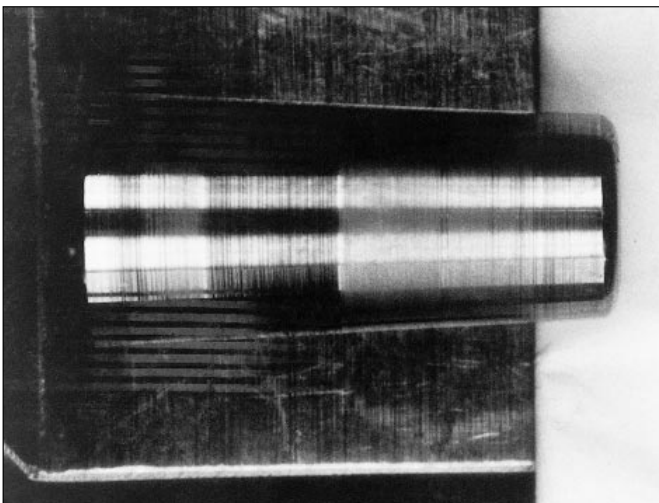

b: Raceway



69: Chart for fig. 68a

Evaluation of running features and damage to dismantled bearings

Pattern of rolling contact

3.3.4.2 Scratches on rolling element outside diameters

Symptoms:

Circumferential notches in the contact areas of rolling elements. Parallel rings in the case of rollers, figs. 70 and 71, and usually like "balls of wool" in the case of balls, fig. 72. Not to be confused with edge tracks (see section 3.3.2.6). Edge running forms tracks with smooth edges due to plastic deformation; scratches have sharp edges. Hard particles are frequently pressed into the cage pockets which cause the scratches, fig. 73.

Cause:

Contaminated lubricant; hard particles become fixed in the cage pockets and act like the grains in a grinding wheel.

Remedial measures:

- Ensure clean mounting conditions
- Improve sealing
- Filter lubricant



70: Deep scratches on rollers as a result of foreign particles in the cage

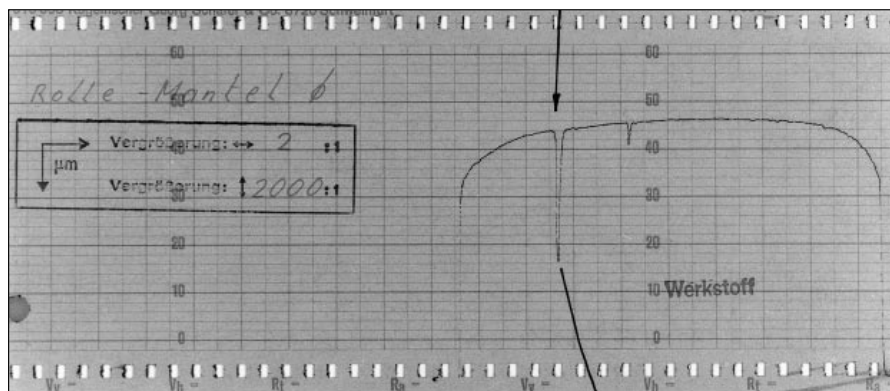

71: Chart for fig. 70.

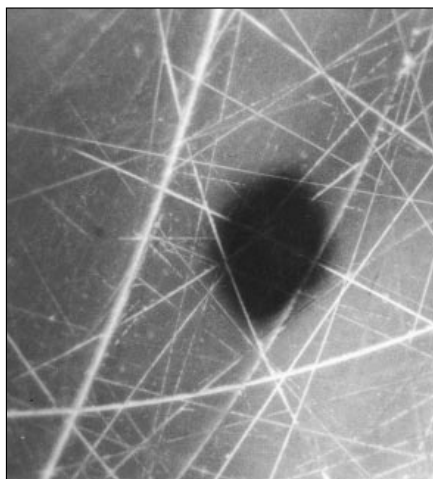

72: Scratches on the ball surface resembling a ball of wool

73: Embedding of foreign material in the cage crosspiece of a cylindrical roller bearing

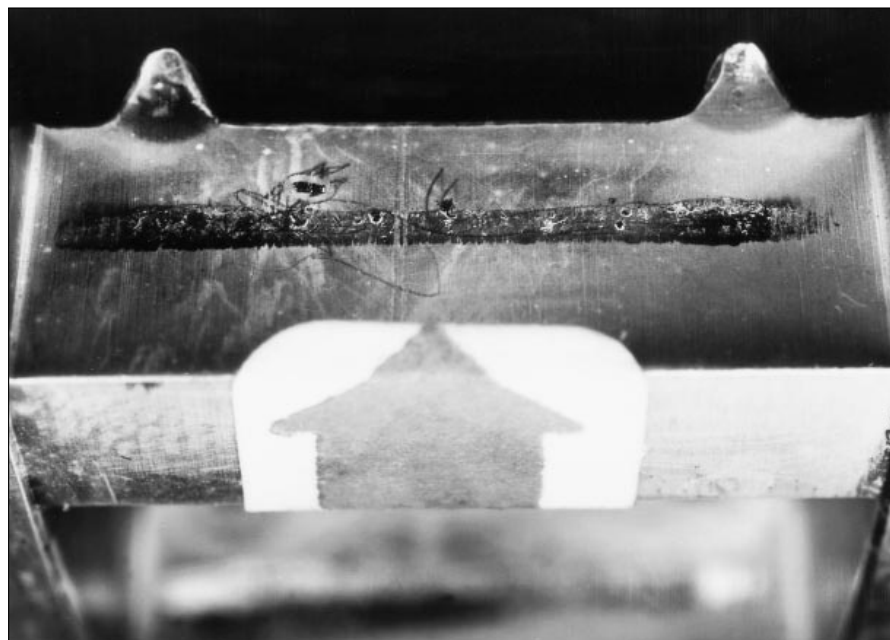

3.3.4.3 Slippage tracks

Symptoms:

Rolling element sliding, particularly in the case of large and heavy rollers e.g. in cageless bearings. Roughening of the raceways or rolling elements. Material often rolled up and with smear marks. Usually not evenly distributed on the surface but in spots, figs. 74 and 75. Found frequently in connection with micro pittings, see "Fatigue as a result of poor lubrication" in section 3.3.2.1.

Causes:

- The rolling elements slide on the raceways when load is low and lubrication is poor. Also due sometimes to load zones which are too short, where the rolling elements brake in the unloaded zone in the cage pockets and subsequently accelerate again when entering the load zone.
- Fast changes in speed.

Remedial measures:

- Use bearings with lower load carrying capacity
- Preload bearings, e.g. with springs
- Reduce bearing clearance
- Ensure sufficient load during the trial run also
- Improve lubrication



74: Slippage tracks on cylindrical rollers



75: Slippage damage on the inner ring of a cylindrical roller bearing

Evaluation of running features and damage to dismantled bearings

Pattern of rolling contact

3.3.4.4 Score marks

Symptoms:

Material displacement at rolling element pitch parallel to the axis in raceways and rolling elements of separable cylindrical roller bearings or tapered roller bearings. Sometimes several sets of such marks displaced to one another by a few degrees on the circumference. Frequently found on just about 1/3 of the circumference and not on the whole circumference, fig. 76.

Causes:

During mounting the single ring and the ring with the rolling element set are

not concentric to one another or are misaligned and are shoved together forcefully. This can be particularly dangerous with large moving masses (large shaft is shoved with the bearing inner ring and rolling elements into the outer ring which has already been pressed into the housing).

Remedial measures:

- Use suitable mounting aids
- Avoid misalignment
- If possible assemble parts with a slow rotating movement

76: Score marks in the raceway of a cylindrical roller bearing inner ring caused by out-of-square insertion into the rolling element set



3.3.5 Damage due to overheating

Symptoms:

Bearing parts badly discoloured*). Raceway/rolling elements plastically deformed to a large extent. Temperature surge. Bearing seizure frequent, fig. 77. Hardness well below 58 HRC.

Causes:

Usually no longer detectable from damage pattern resulting from overheated bearings. Possible causes:

- Bearing clearance in operating condition too low, particularly with high speed bearings

- Inadequate lubrication
- Radial preload due to external heating
- Overlubrication
- Impeded running due to cage fracture

Remedial measures:

- Increase bearing clearance
- In the case of external heating ensure sufficiently slow heating up and cooling down, that is, uniform heating of complete bearing
- Avoid lubricant pile-up
- Improve lubrication

*) Note on discolouration:

Tempering colours are related to overheating damage. Brown and blue shades develop depending on how high the temperature is and how long it takes effect. They resemble greatly the oil discolouration which appears far more frequently (see section 3.3.1.1). Therefore conclusions regarding an excess operating temperature may on no account be drawn from discolouration alone. The spreading of the discolouration may serve to differentiate between tempering colours and oil discolourating: while the latter is frequently found only on the rolling elements and directly in the track area the former usually covers a large part of the free bearing surfaces. However, the only answer to the occurrence of extremely high operating temperatures is a hardness inspection.

77: The rollers left deep impressions in the raceway of a seized, overheated cylindrical roller bearing.

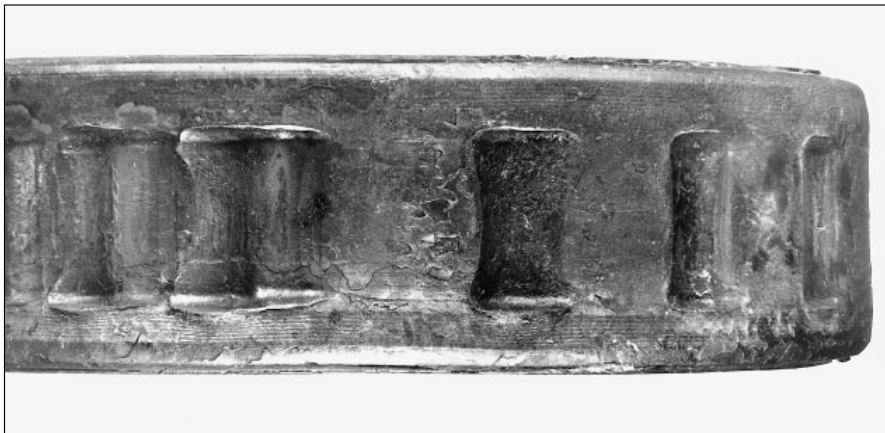

Evaluation of running features and damage to dismantled bearings

Lip contact

3.4 Assessment of lip contact

Fig. 78 illustrates a well run-in lip surface.

3.4.1 Damage to lip and roller faces in roller bearings

3.4.1.1 Scoring due to foreign particles

Symptoms:

Arc-shaped scratches in the lip surface or roller face (particularly frequent with tapered roller bearings), figs. 79 and 80. Their depth into the lip area depends on the rolling element radius the foreign particle became stuck in.

Causes:

Hard foreign particles in lubricant which are drawn into the area of contact between roller face and lip.

Remedial measures:

Improve lubricant cleanliness.

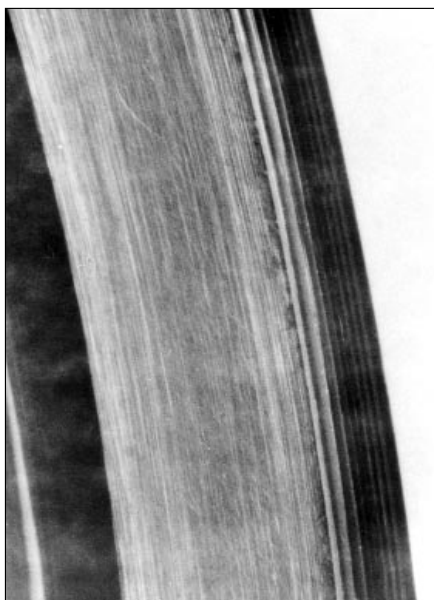

78: Normal run-in lip contact track in a tapered roller bearing

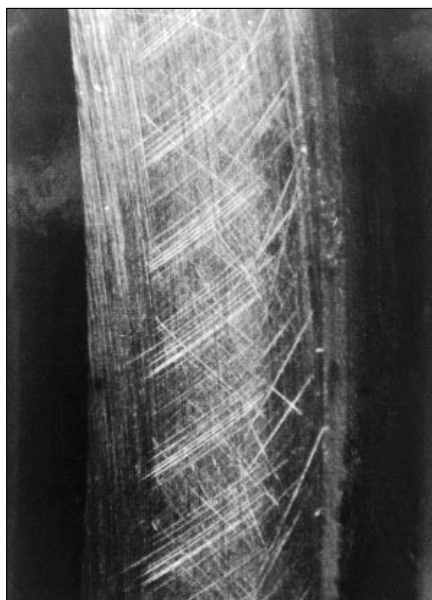

79: Lip area scoring due to foreign particles

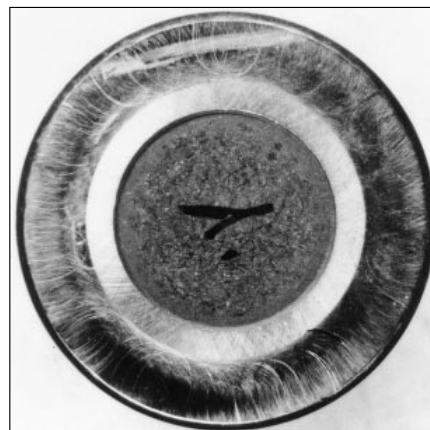

80: Scoring on the face of a tapered roller

3.4.1.2 Seizure in lip contact

Symptoms:

Partial or large-area welding and deep scratches in the lip and roller face areas, figs. 81 and 82. Also lubricant coking in this area. Frequently related to very high loads.

Causes:

- Inadequate lubrication with high loads and high speeds (quantity or operating viscosity of lubricant too low)
- Inadequate lubrication with high loads and low speeds when there is no hydrodynamic lubricating film between roller face and lip
- Too high preload of tapered roller bearings
- Detrimental preload due to heat expansion
- Skewing of rollers for example in the case of raceway wear, ring tilting or insufficient adjustment, fig. 81
- Axial load too high on cylindrical roller bearings
- Axial preload of inner ring too high for out-of-square mating surfaces.

Remedial measures:

- Improve lubrication (increase viscosity, EP additives, increase lubricant quantity)
- Ensure correct adjustment of bearings

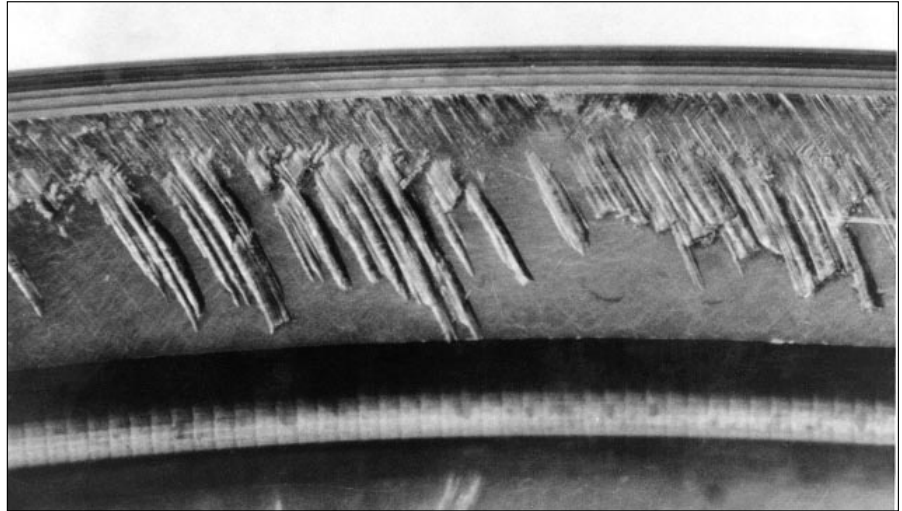

81: Skewing rollers caused seizure marks at the lip when in contact with its edges.

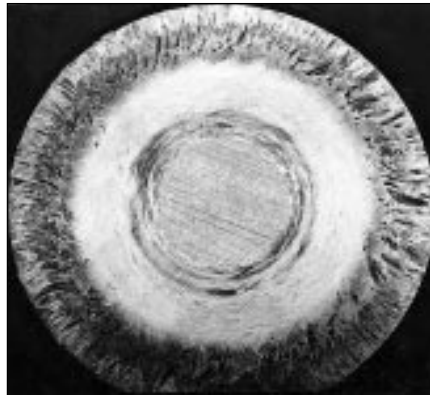

82: Seizure can arise at the roller face and lip when the lubricant supply is inadequate and loads are high.

Evaluation of running features and damage to dismantled bearings

Lip contact

3.4.1.3 Wear in the lip contact area

Symptoms:

In the case of roller bearings poor lubrication conditions are first revealed by the sliding contact roller face/lip. In serious cases the previously mentioned seizure phenomena result. In all cases, however, the contact areas have wear characteristics. This can be clearly seen in the cross profile chart of the lip or roller faces, fig. 83. Rims frequently develop at the roller faces also. In the case of tapered roller bearings a reduction in preload or extended axial clearance results. This leads, for example in transmissions with load direction inversion, to increased running noise. The amount of wear in the lip contact area enters only about 1/3 of the axial clearance in the case of tapered roller bearings due to the geometric conditions. Lip wear is also an indication for wear in the raceway or roller outside diameter.

Causes:

- Inadequate lubrication (type, quantity)
- Contaminated lubricant

Remedial measures:

- Ensure utmost cleanliness
- Choose suitable lubricant (viscosity, EP additives) and ensure sufficient supply

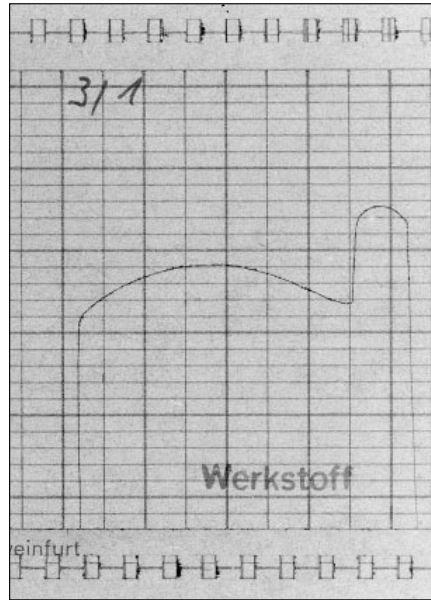

83: Cross profile chart of a worn tapered roller face



84: Rim formation at the tapered roller

3.4.1.4 Lip fractures

Symptoms:

Supporting lips are completely or partly broken off or cracked, fig. 85.

Causes:

- Axial load unacceptably high
- Lip insufficiently supported, fig. 20
- Axial shock load

- Subsequent damage of cage and rolling element fracture
- Mounting damage

Remedial measures:

- Ensure good lip support design
- Keep load within the limits assumed for designing
- Observe mounting specifications

85: Lip broken off a barrel roller bearing. The inner ring was driven onto the shaft with a hammer.



Evaluation of running features and damage to dismantled bearings

Lip contact

3.4.2 Wear of cage guiding surfaces

Symptoms:

Wear may result when cages – particularly brass cages – are guided at the lips of bearing rings. The surface is usually badly roughened and seizure also results (cage material clings to lip). A shoulder develops at the lip when there is a lot of wear since the cage is not as a rule in contact with its entire width, fig. 86. Similar wear characteristics are also found at the side edges of the corresponding cage, see section 3.5.1. It is particularly hazardous for the inner ring lip contact of high-speed bearings.

Causes:

- Insufficient lubricant supply to contact areas, often inadequate drainage of the lubricant
- Contaminated lubricant
- Speed too high for the bearings applied
- Excess tilting during assembly
- Unexpectedly high operating temperature in the case of outer ring guided brass cages (different heat expansion steel/brass)

Remedial measures:

- Improve lubrication (greater flow, more cleanliness)
- Use bearings designed for operating conditions in question
- Coat cage

86: Bad contact marks on the cage guiding surface of an outer ring lip with smeared on material



3.4.3 Damage to seal running areas

3.4.3.1 Worn sealing lip tracks

Symptoms:

At the area of the sealing lip contact a circumferential groove, usually shiny, develops in the lip. Also in conjunction frequently with worn sealing lips and damage to the bearing as a result of penetrating contaminants. Corrosion in the sealing area is found in several cases as well, fig. 87.

Causes:

- Extreme amount of external dirt, particularly in moist environment.
- Lip runs dry.

Remedial measures:

- Use preseals, e.g. flinger rings.
- Lubricate sealing lip.

3.4.3.2 Discolouration of sealing track

Symptoms:

Brown or blue colour in the area of sealing lip contact, particularly in the case of shaft seals. Excess heating leads to hardening and intense wear of the sealing, see section 3.6.1.

Causes:

- Intense heating of lip and shaft area due to overlapping or to a high press-on force of the sealing
- Sealing lip area of contact not sufficiently lubricated

Remedial measures:

- Lubricate sealing lip
- Reduce press-on force insofar as permissible for the sealing effect

87: Corrosion in the area of the sealing track at the lip of an angular contact ball bearing

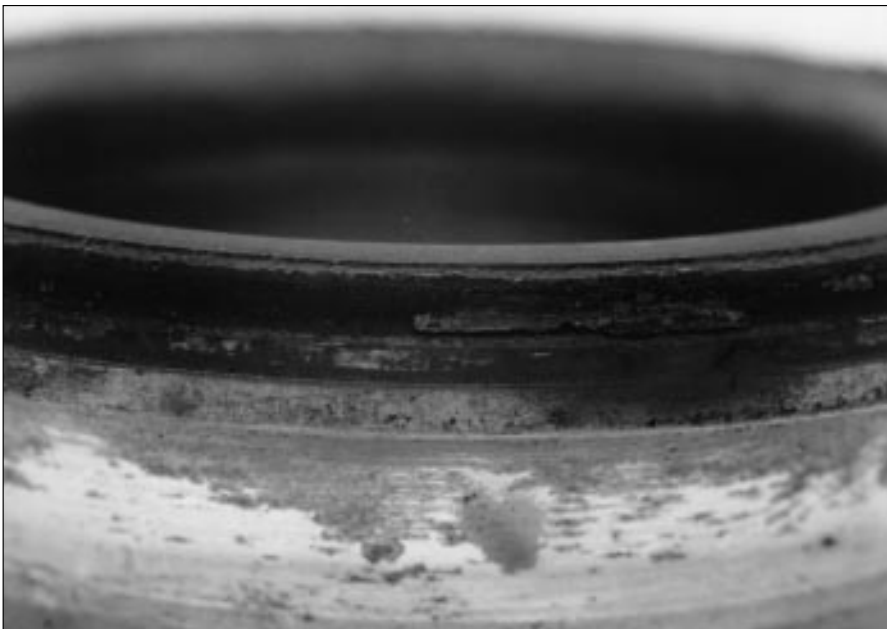

Evaluation of running features and damage to dismantled bearings

Cage damage

3.5 Cage damage

3.5.1 Wear due to starved lubrication and contamination

Symptoms:

In the case of cages with lip guidance wear in the side edges, for those guided by rolling elements wear in the pockets. Subsequent damage due to advanced wear could cause rolling element guidance to develop into lip guidance and abrade there also or vice versa. Wear is generally in the axial direction to a large extent symmetric in the pockets or in the case of cylindrical roller bearings at both side edges, fig. 88.

Causes:

- Lubricant contaminated with hard foreign particles
- Too little or unsuitable lubricant

Remedial measures:

- Ensure clean assembly conditions
- Filter lubricant
- Increase lubricant flow through and/or apply a different viscosity

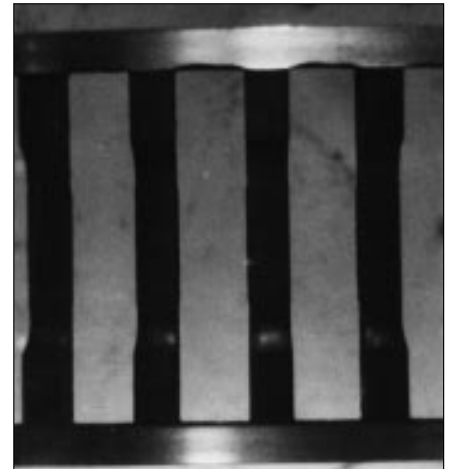

88: Wear of cage side edges

3.5.2 Wear due to excess speed

Symptoms:

Wear of cage outside diameter due to grazing at the bearing outer ring, fig. 89.

Causes:

- Excess speed
- Unsuitable cage construction selected

Remedial measures:

- Use different type of cage

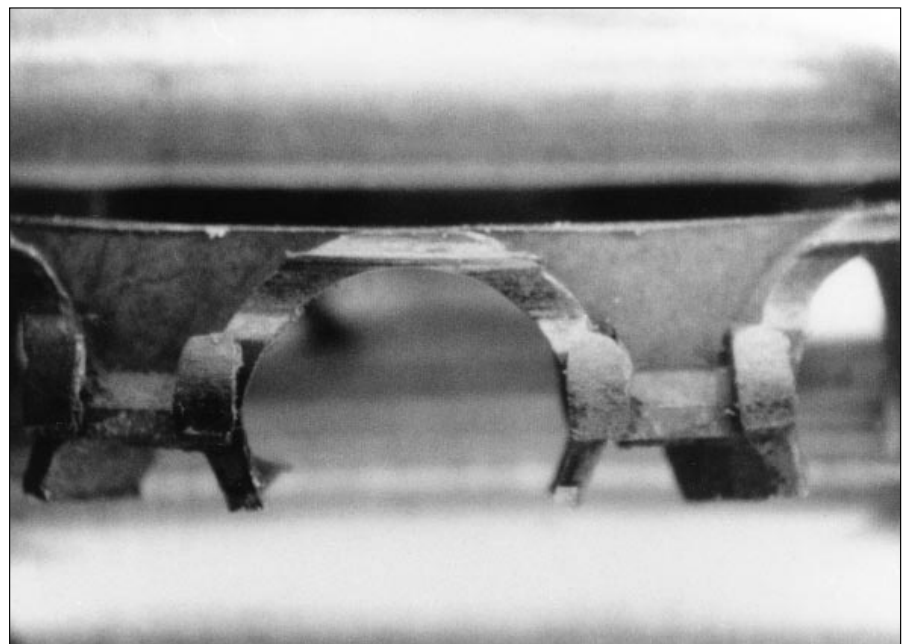

89: Wear of cage outside diameter due to grazing at the bearing outer ring

3.5.3 Wear due to roller skewing

Symptoms:

Roller skewing results when roller bearings carry low loads or badly tilt or when tapered roller bearings are not sufficiently adjusted. If the skewing forces cannot be accommodated by the lips, wear areas which are diagonally opposite one another develop due to the unpermissibly high load in the cage pockets. This can lead to fractures between cross-piece and side edge in the advanced stage of damage, fig. 90.

Causes:

- Unpermissible tilting of bearings, partly due to misalignment
- Faulty adjustment of clearance in the bearings

Remedial measures:

- Adjust bearings correctly
- Use self-aligning bearings, avoid misalignment

90: Diagonal wear in cage pockets of roller bearings

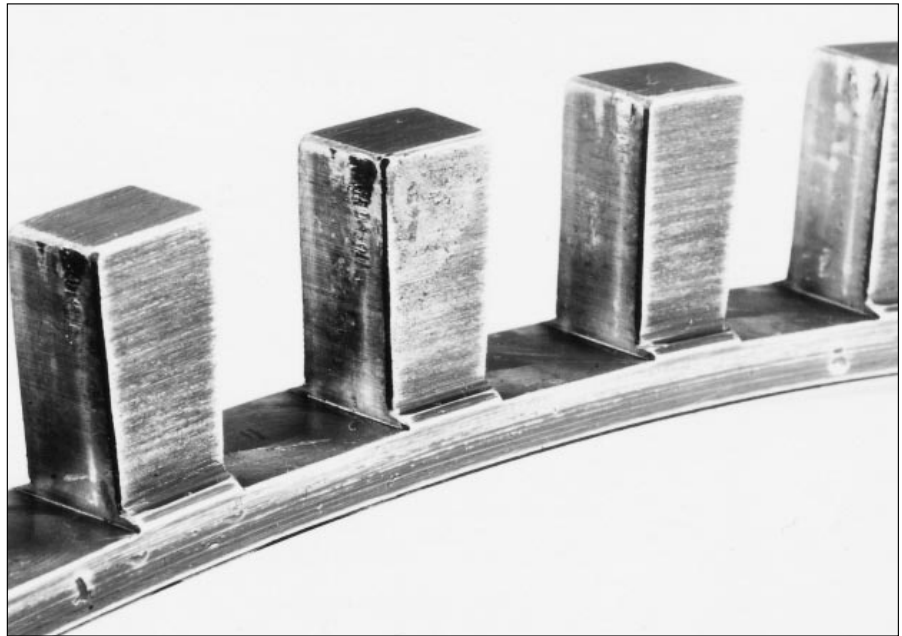

3.5.4 Wear in ball bearing cages due to tilting

Symptoms:

Intense wear at the webs between the cage pockets, deformation or fracture may occur, fig. 91 (tracks, compare with fig. 38).

Causes:

- Excess tilting of bearing rings to one another, e.g. ball bearings with combined load. Varying circumferential velocity of balls as a result.
- Stress in cage area high, particularly with poor lubrication

Remedial measures:

- Avoid tilting as much as possible
- Apply eventually self-aligning bearings or bearings with polyamide cages
- Special design: long hole pockets

91: Bearing rings tilting towards one another led to high constraining forces between balls and cage which, in turn, led to web fracture.



Evaluation of running features and damage to dismantled bearings

Cage damage

3.5.5 Fracture of cage connections

Symptoms:

- Loosening of riveted joints, rivet fracture (fig. 92)
- Breaking off of cage prongs

Causes:

- Vibrations or shocks which superimpose the normal cage stress, e.g. vibrating units or vehicles
- Tilting in the case of deep groove ball bearings

Remedial measures:

- Use of solid cage rather than pressed cage
- Use of window-type cage particularly when stress is great

92: Fractured cage-rivet connections may result from vibration stress.

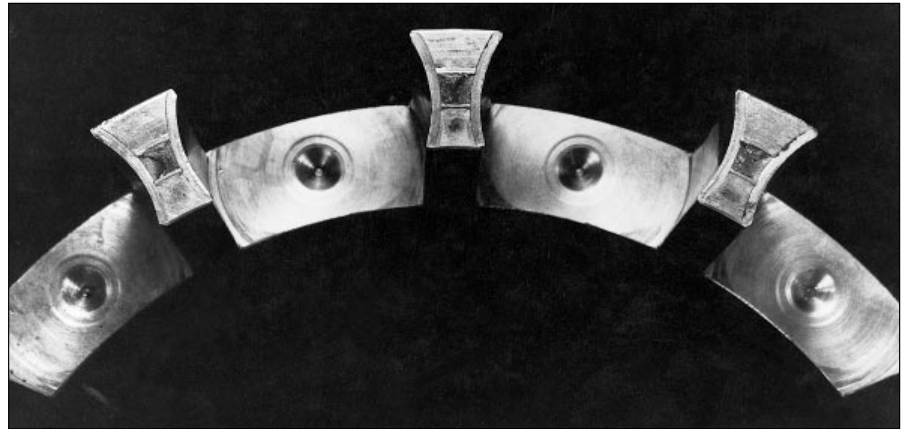

3.5.6 Cage fracture

Symptoms:

Fracture of cage side edges (fig. 93), crosspiece fracture more seldom

Causes:

- Mounting damage
- Kinematically permissible speed exceeded
- As a result of wear and due to poor lubrication (see section 3.5.1)
- Moment load too high or tilting of ball bearings (see section 3.5.4)
- In the case of tapered roller bearing pairs which have a large clearance, also when axial loads reverse quickly

Remedial measures:

- Mount carefully
- Filter lubricant
- Increase lubricant flow through and/or use different viscosity
- Avoid tilting as much as possible
- Operate bearing pair preloaded if possible

93: Disruptive fracture at the side edge of a spherical roller bearing cage



3.5.7 Damage due to incorrect mounting

Symptoms:

Initial fusing in the case of plastic cages, grooves or warping in the case of metal cages, figs. 94 and 95.

Causes:

- Incorrect heating of the bearings for mounting
- Unsuitable mounting aids

Remedial measures:

Mount according to manufacturer's specifications (see for example FAG Publication WL 80 100 "Mounting and Dismounting of Rolling Bearings").

94: Melted faze of plastic cage in the case of incorrect bearing heating on a heating plate



95: Metal cage with dents

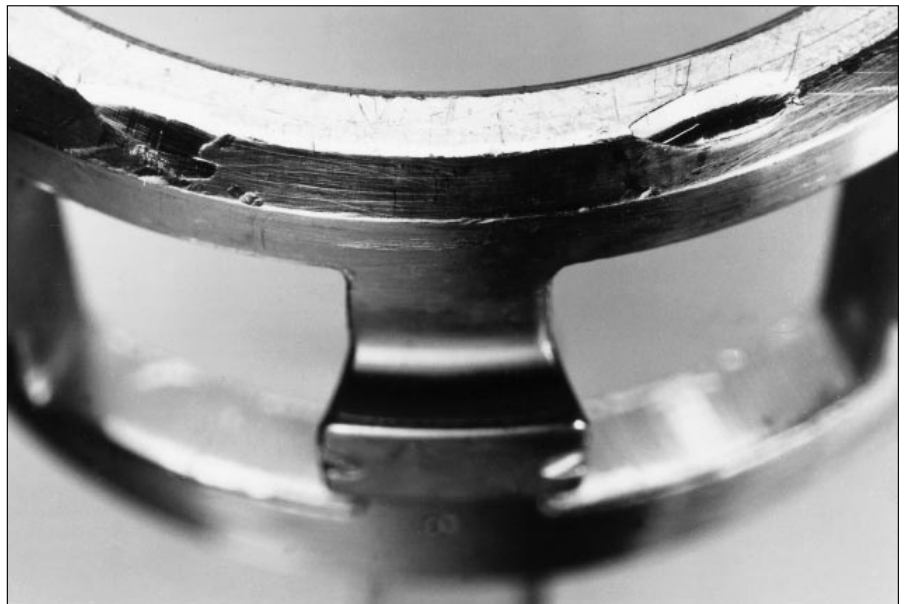

Evaluation of running features and damage to dismantled bearings

Sealing damage

3.6 Sealing damage

3.6.1 Wear of sealing lips

Symptoms:

Sealing lips no longer like edges but widened. Cracks in sealing material, sealing lip partly broken off, figs. 96, 97.

Causes:

- Operating temperatures too high for sealing material
- Extreme amount of dirt at the sealing lip
- Sealing interference too high
- Sealing lip not lubricated

Remedial measures:

- Adapt sealing material to suit operating temperatures.
- Use non-rubbing pre seal
- Grease sealing lip.

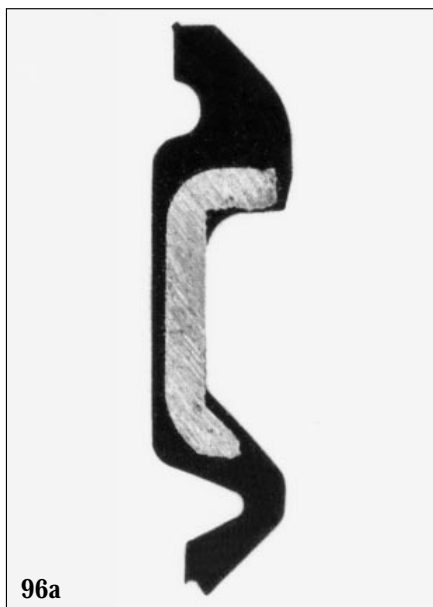

96a

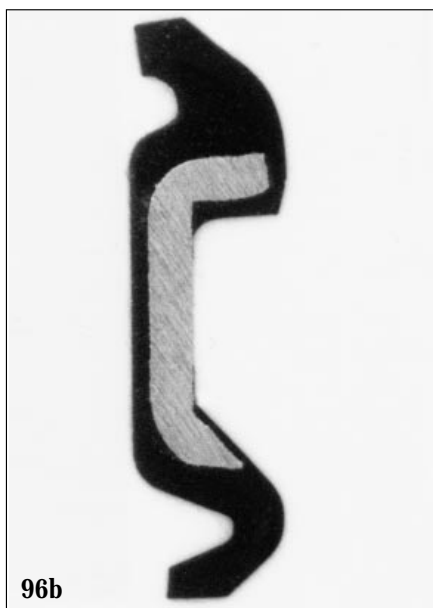

96b

96: Cross section of a seal.

a: new sealing lip; b: worn sealing lip

97: a: Hardened sealing with wear and fractures

b: Part of worn lip close up



97a

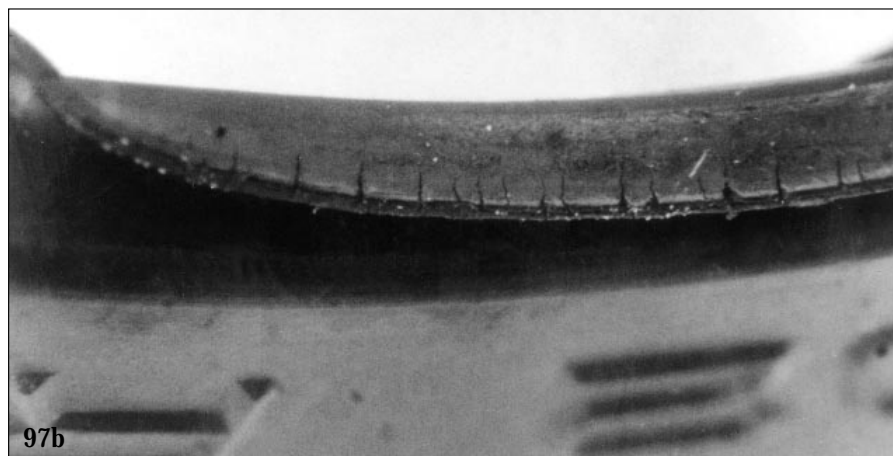

97b

3.6.2 Damage due to incorrect mounting

Symptoms:

Seal is too far inside, dented, discoloured, scratched. Sealing lips are turned up, figs. 98 and 99.

Causes:

- Incorrect mounting aids
- Bearing heated too much
- Sealing occasionally removed
- Bearing blown off with compressed air

Remedial measures:

- Ensure careful mounting with suitable mounting devices.
- Never open sealed bearings if they are to be subsequently used.

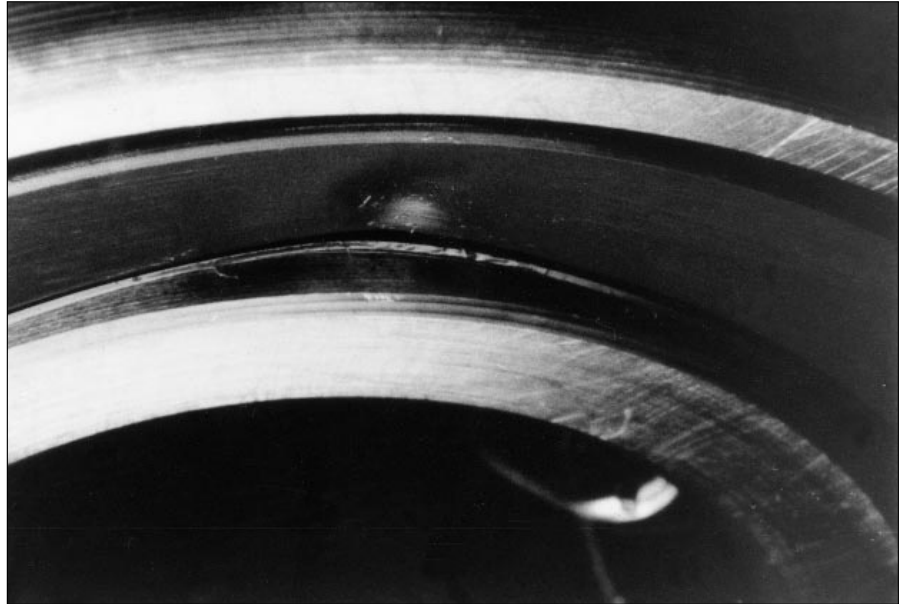

98: Dented seal with scorings

99: Turned-up sealing lips



Other means of inspection at FAG

Geometric measuring

4 Other means of inspection at FAG

Experience has revealed that in the majority of bearing damage cases, the cause of damage can be clarified by closely considering the damage symptoms together with the data on operating conditions. In a large amount of the remaining unclarified cases the cause of damage can be determined with the aid of a stereomicroscope. Only a very small amount of bearing damage cases require a profound examination of the damage symptoms and an intensive analysis of the application conditions. FAG's research and development capacities include the most diverse and highly developed technical inspection means with some very special features. A cost-benefit comparison of such inspections is recommended in advance as the latter may prove quite expensive.

The main inspection areas accompanied with some examples are presented in the following sections.

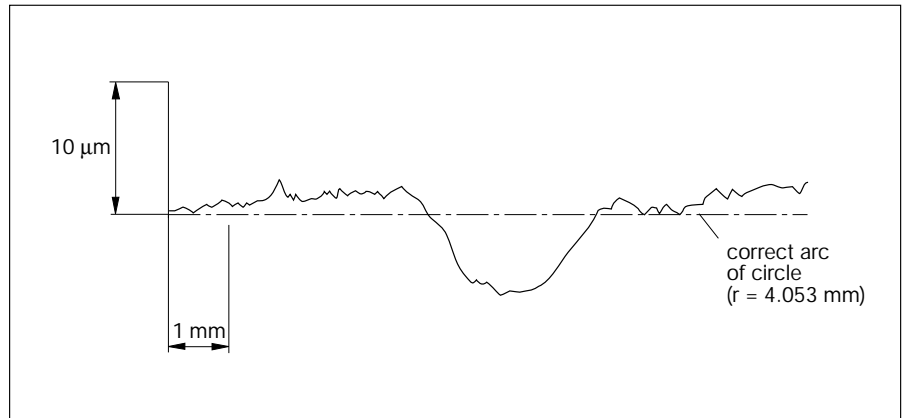

100: Profile of a deep groove ball bearing raceway with wear groove (raceway curve compensated for by measuring device)

101: Form Talysurf



4.1 Geometric measurements of bearings and bearing parts

FAG strives constantly to improve the production quality of rolling bearings. We therefore have the most sophisticated equipment with diverse measuring devices for dimensional and form inspection both on the spot in our quality assurance and in our own laboratory:

- Length and diameter measuring exactly to the micrometer
- Inspection of form and radius contours with a magnification of up to 100 000 fold, figs. 69, 100 and 101

- Deviation of roundness check with up to 100 000 fold magnitude including frequency analysis of waviness, figs. 102 and 103

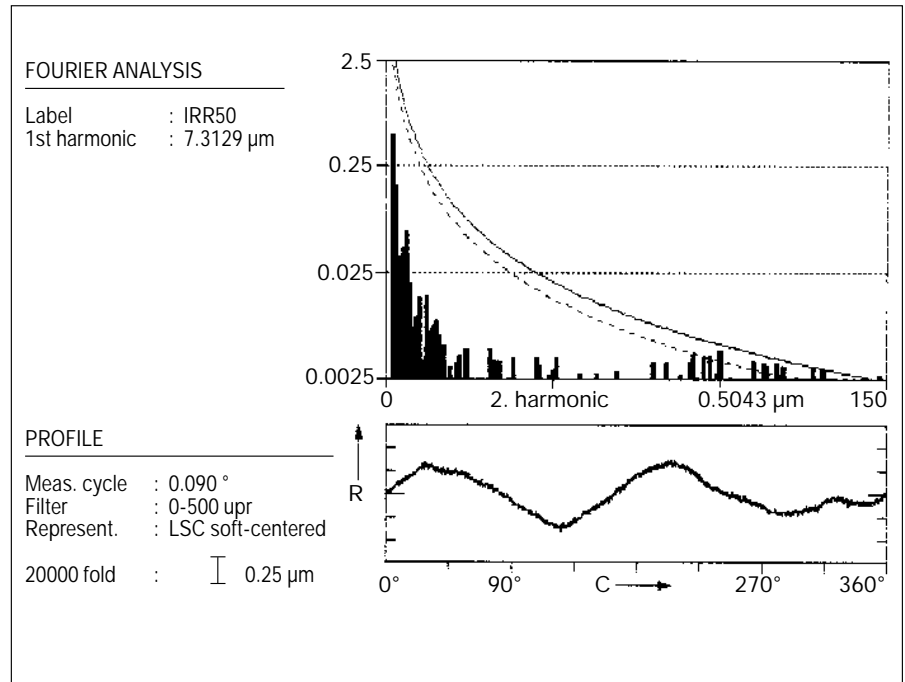

102: Form drawing with frequency analysis of waviness, inner ring 6207



103: Form measuring system

Other means of inspection at FAG

Geometric measuring

- Roughness measurements down to one hundredth of a micrometer, fig. 104
- Inspection of form and position tolerances on form measuring systems (FMS) and coordinate measuring machines, also for very irregularly formed construction parts such as cast steel housings, fig. 105
- Inspection of bearing clearances and radial runout of individual parts

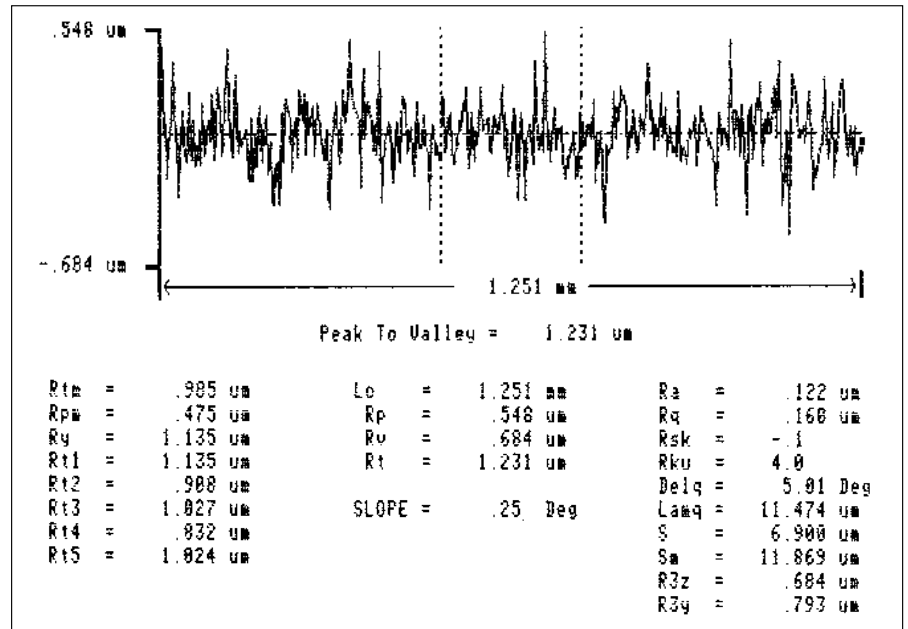

104: Roughness measuring chart with characteristic values



105: Coordinate measuring machine

4.2 Lubricant analyses and lubricant inspections

FAG has laboratories and test floors for inspecting the quality and suitability of lubricants for rolling bearing applications.

Laboratory analyses of lubricants from failed bearings frequently supply the decisive information necessary to clarify the cause of failure. The main inspection means are:

- Amount and type of contamination present
 - solid, fig. 106a
 - liquid (humidity)
- Use of anti-oxidants
- Ageing, fig. 106b
- Change in viscosity
- Additive content (reduction/degradation)
- Oil-soap relation in greases
- Determination of type and class of lubricant, e.g. evidence of lubricant mixture during relubrication, fig. 106b

The extraction of a suitable lubricant sample is an essential prerequisite for reliable information based on the lubricant inspection (see section 2.2). The origin of contaminants can almost always be determined from the results of their analyses. A direct indication of possible measures to stop wear, for example, can therefore be obtained just as conclusions regarding suitable oil change intervals or a fresh grease supply can be drawn from information on the general condition of an oil or grease after a certain running period.

106 a: Inspection of contaminants, ICP-AES Analysis

Element	Lambda	Factor	Offset	low min	low max	high min	high max
Cobalt	228,616	1,673	268	962	415	179515	107157
Manganese	257,610	1,318	-76	-121	-34	67816	51496
Chromium	267,716	1,476	381	669	195	76696	51688
Copper	324,754	0,834	-471	80	660	2297	3316
Molybdenum	281,615	1,073	-17	89	99	47781	44543
Nickel	231,604	1,778	4	114	62	38487	21640
Vanadium	311,071	0,937	-37	5	45	64228	68560
Tungsten	400,875	0,742	-16	4	26	14129	19053
Silicon	251,611	2,173	310	509	92	2385	955

sample: solids in contaminated lubricant					method: steel 1 M(3)				
	Co	Mn	Cr	Cu	Mo	Ni	V	W	Si
x	.0107	0.636	1.412	0.185	0.797	0.271	.327	.002	0.359 %
s	.0004	.0002	.011	.0002	.0032	.0063	.0007	.0099	.0006
sr	4.11	0.67	0.03	1.18	0.40	2.31	0.22	57.44	0.06

106 b: FT-IR Analysis of lubricant

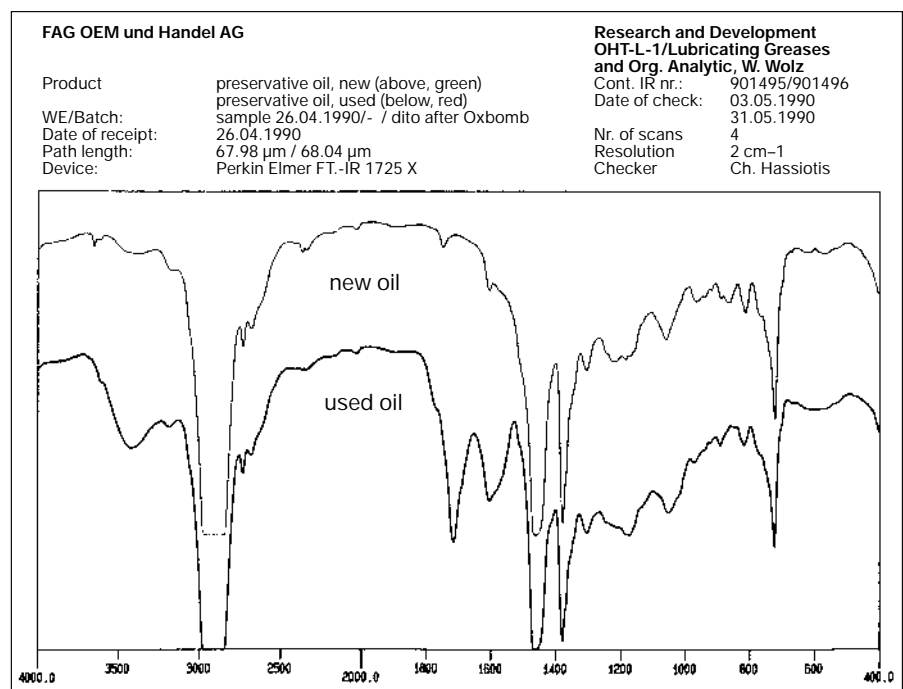

Other means of inspection at FAG

Lubricant analyses and lubricant inspections

New lubricants, on which there are no findings concerning their suitability for lubricating rolling bearings, are also used in special cases of applications. FAG test rigs have been developed to check the properties of such greases and oils. They have also been standardized and adopted by the lubricant industry for testing new products, fig. 107.

107: Test rig for determining lubricant quality



4.3 Material inspection

The condition of the material of all bearing parts is of decisive importance if the bearings are to be fully efficient. Indeed, bearing damage is very seldom due to material or production faults, fig. 11, but a material inspection can provide important information in cases of doubt. In a number of cases changes in the material condition are due to unexpected bearing application conditions.

The main inspections in this area are:

- Inspection of hardness and more seldom, tensile strength or notch impact bending strength

- Metallographic assessment of structure
- Making zones of unpermissible heating visible by etching the contact areas
- Crack inspection by means of ultrasound or eddy current
- Radioscopic measuring of retained austenite
- Inspection of material cleanliness
- Material analysis

In addition to determining material faults, these inspections can provide information for example on unpermissible slippage (sliding heat zones, fig. 108) or unexpectedly high operating temperatures (change in structural parts during operating and dimensional changes as a result).

108: Section of heat influence zone

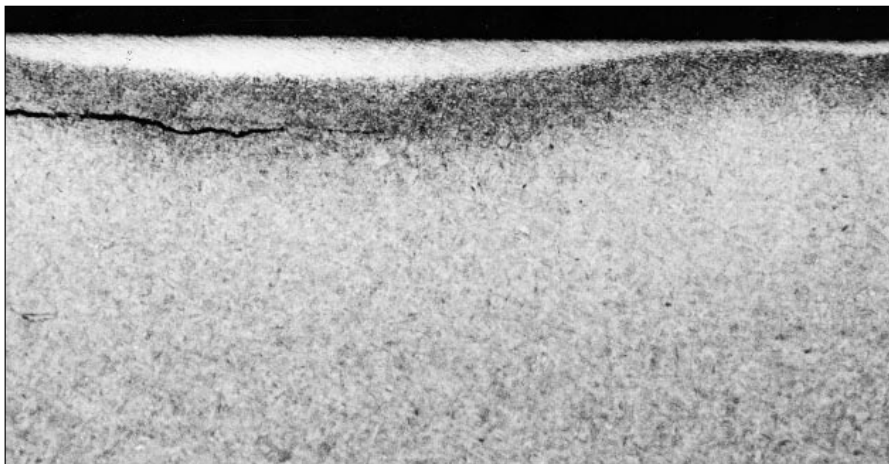

Other means of inspection at FAG

X-ray micro structure analysis

4.4 X-ray micro structure analysis

The radioscopic investigation of the lattice structure (cf. Measuring retained austenite in section 4.3) also allows one to draw very important conclusions on the residual stress "frozen" in the material and the stressing on which it is based. It is applied to determine with good approximation the actual load of bearings after operation. This may be particularly crucial in damage cases where the actual load situation cannot be attained by calculation. The specific raceway stress, however, must have reached a level of about $2,500 \text{ N/mm}^2$ for a longer period since it is only above this load that the plastic deformation of the material lattice occurs and only then can it be tested and quantified by means of X-ray diffraction, fig. 109. You could refer to the booklet "Schadenskunde in Maschinenbau", Expert Verlag 1990, for example, under "Schadensuntersuchung durch Röntgenfeinstrukturanalyse" for a detailed report on determining residual stress and calculating stress. We have provided a brief summary for you below.

The residual stress present in small areas (size a few square millimeters surface, $1/100$ millimeters in depth) can be calculated back from the lattice expansion measured by means of X-ray diffraction. Measuring is carried out layer by layer for the different depths below the raceway of a bearing ring by an electrochemical surface discharge. A pattern as in fig. 110 is then obtained. From the whole deformation depth and from the depth where stress is greatest, the maximum external load can be deduced on the one hand and, on the other hand, the share of possible sliding stress in the raceway. This is a vital contribution towards the search for damage causes, particularly if the values measured deviate greatly from those expected on the basis of calculations.

109: X-ray micro structure analysis equipment



110: Residual stress pattern as attained from an X-ray micro structure analysis; high tangential force portion in outer ring 6207E, no increased stress in reference bearing 6303E

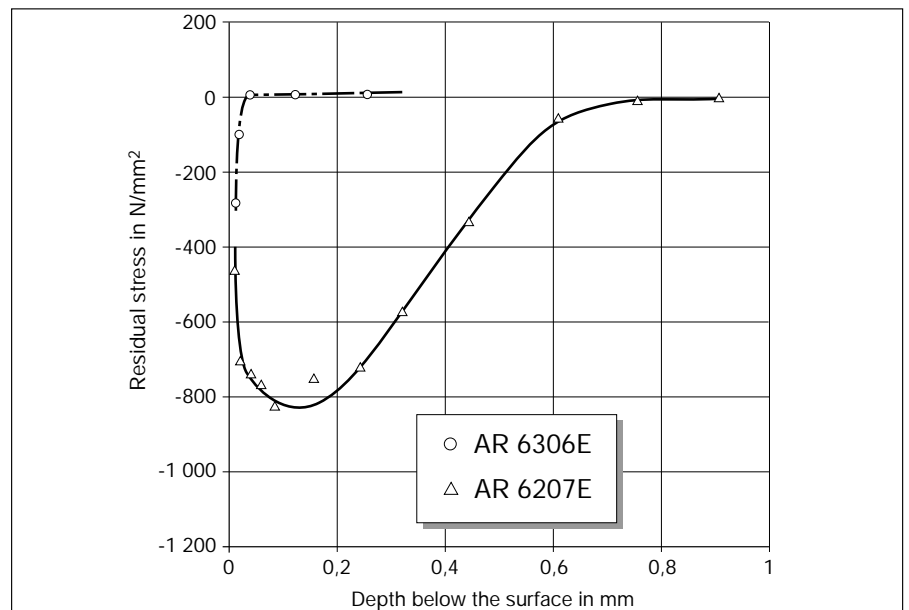

Other means of inspection at FAG

Scanning electron microscope investigations

4.5. Scanning electron microscope investigations (SEM)

When investigating damage a stereomicroscope is usually applied in addition to the naked eye to detect the individual failure causes. However, the damage-related details are sometimes tiny. Due to the relatively large wave length of visible light, the definition of the image of light-optical projections is limited.

With the usual surface unevenness of damaged rolling bearing raceways, photos can only be enlarged sharply defined up to 50 fold. This obstacle in light-optical inspection of surfaces can be bypassed with the very short-wave electron beam in a scanning electron microscope (SEM). It makes the detection of details several thousand times greater, fig. 111.

The scanning electron microscope is therefore a vital aid for the visual inspection

of raceways damaged by wear or the passage of current, fractured areas, foreign particle indentations, and material inclusions, figs. 112a, b and c.

112: SEM photos of surface structure in various sizes.

a: raceway ok

b: hard foreign particle indentations

c: fatigue damage commencing

111: Scanning electron microscope

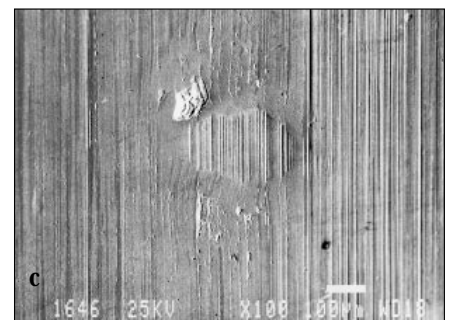
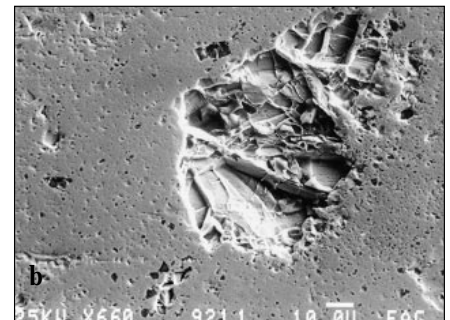
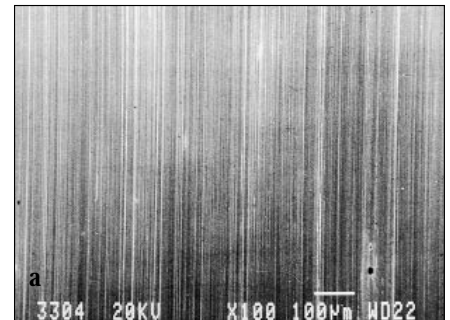

Other means of inspection at FAG

Scanning electron microscopic inspection

It is also possible to make the so-called electron beam micro analysis when using spectrometers together with the SEM. It inspects the material composition in the volume range of approx. 1 micron³. This helps to determine the origin of foreign particles still stuck in the cage pockets of a bearing, figs. 113a and b. Other applications with it include the inspection of coatings or of reaction layers on the contact areas or the examination of material compositions in the micro area.

113: Micro analysis of foreign particles
a: Foreign particles in cage crosspiece

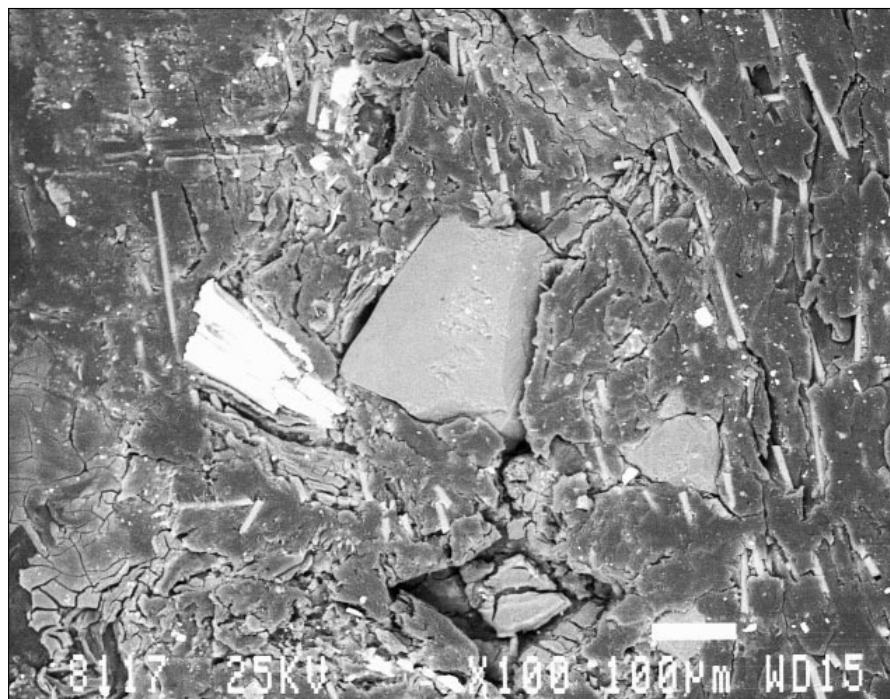

113 b: Material composition of foreign particles

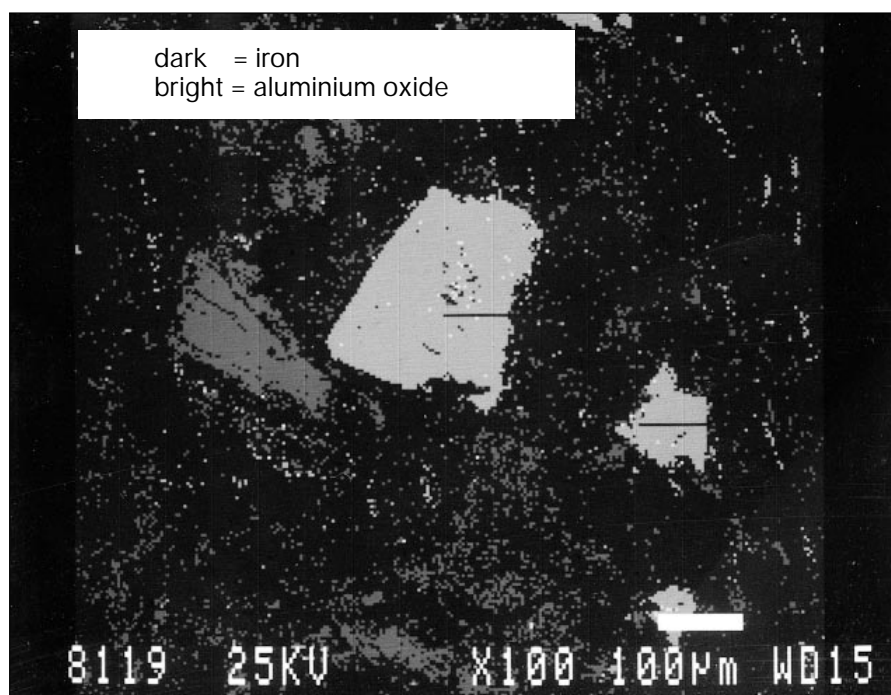

4.6 Component tests

There are numerous test rigs in FAG's development department for testing the efficiency of newly designed products. In some cases such tests can be used to clarify the cause of bearing damage. They include, on the one hand, direct tests on customer units for example deformation and vibration measuring on machines and, on the other hand, tightness inspections, measuring of frictional moment, and life tests on test rigs, figs. 114 and 115. The tests are performed under clearly defined conditions where the expected results are reliably foreseeable. Once the bearings have met the requirements in the experiment, the inspection of the damage case in question must then focus on the examination of actual operating conditions (unexpected extra load, also due to faulty mounting etc.). Should the bearings fail after an unexpectedly short running period, the technical monitoring facilities of the test rigs allow damage to be detected in its stage of origin. This is often a problem in the field but it is also frequently decisive for finding the cause of damage.

114: Test rig for inspecting the efficiency of rolling bearing seals



Other means of inspection at FAG

Component tests

115: Test rig for simulating operating stress of car wheel bearings

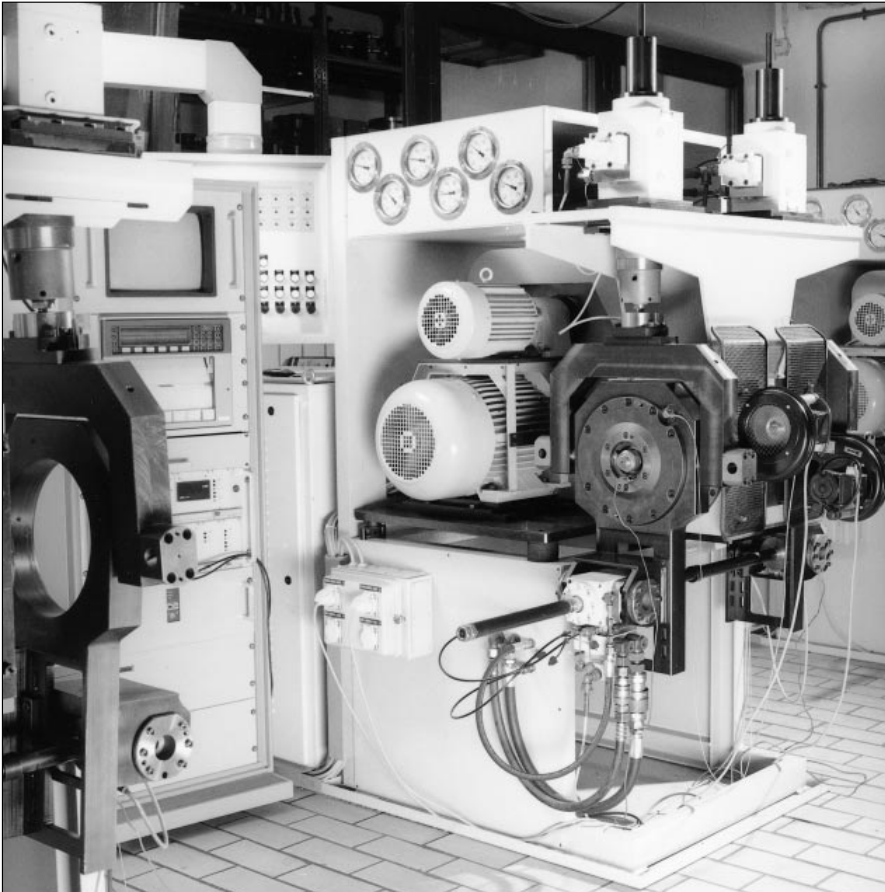

4.7 Calculation of load conditions

In several cases bearings, whose load situation is not known completely, are selected for new constructions on the basis of experience with older, similar units. When bearing damage arises at a later stage, an accurate calculation of the mounting conditions frequently helps in the search for its cause. A comparison of the expected life calculation and the life actually attained is particularly important as well as the calculation of lubricating conditions. FAG has an extensive collection of calculation programs at its disposal. Even the most sophisticated bearing cases present no problem. The programs can calculate values for the external bearing load, tilting between mounted rings, internal stress, kinematic procedures within the bearing, deformation of mating parts, temperature marches and the like. The complexity of the programs ranges from simple evaluations of analytical formulae to the performance of various numerical iterations with non-linear approximate solutions and even to extensive three-dimensional strength calculations for mating parts by means of the finite elements, fig. 116.

116: Calculation of stress on a journal roller bearing housing by means of the Finite Element Method (FEM)

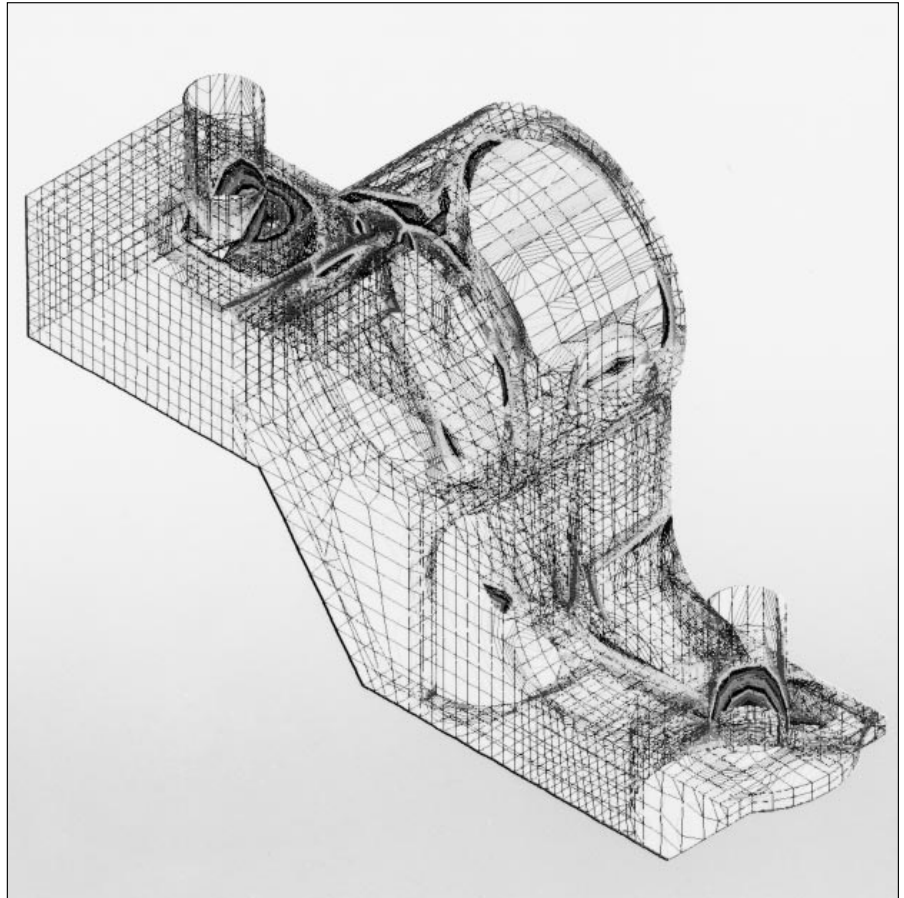

Notes

Rolling Bearing Damage

Recognition of damage and bearing inspection

Every care has been taken to ensure the correctness of the information contained in this publication but no liability can be accepted for any errors or omissions.

We reserve the right to make changes in the interest of technical progress.

Rolling Bearing Damage

Recognition of damage and bearing
inspection

Publ. No. WL 82 102/2 ED

FAG Bearings Corporation

A company of the FAG Kugelfischer Group

200 Park Avenue · P.O. Box 1933

Danbury, Connecticut 06813-1933

Telephone (02 03) 7 90 54 74 · Telefax (02 03) 8 30 81 71

Rolling Bearing Damage

Recognition of damage and bearing inspection

Every care has been taken to ensure the correctness of the information contained in this book but no liability can be accepted for any errors or omissions.

We reserve the right to make changes in the interest of technical progress.

Rolling Bearing Damage

Recognition of damage and bearing inspection

FAG

Rolling Bearings

FAG SOUTH EAST ASIA PTE LTD

Publ. No. WL 82 102/2 ESI



Rolling Bearing Damage

Recognition of damage and bearing inspection

Every care has been taken to ensure the correctness of the information contained in this book but no liability can be accepted for any errors or omissions.

We reserve the right to make changes in the interest of technical progress.

Rolling Bearing Damage

Recognition of damage and bearing inspection

FAG

Rolling Bearings

FAG Bearings Limited

Publ. No. WL 82 102/2 EC

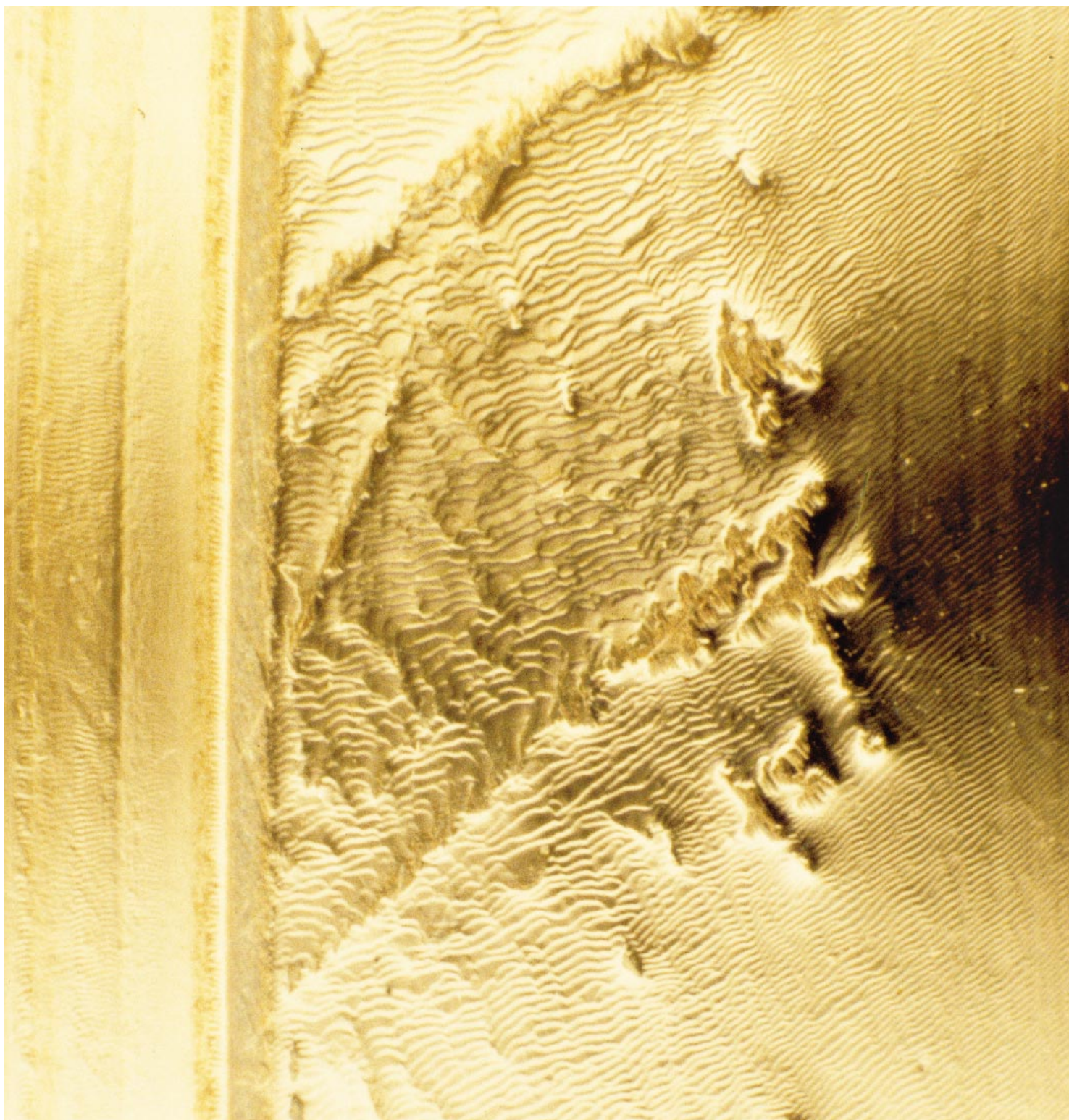

Contact Partners for Technical Advice and Sales

FAG Bearings Limited

National Sales Division

Head Office

5965 Coopers Avenue

Mississauga, Ontario, Canada L4Z1R9

Tel.: (905) 890-9770 · Fax: (905) 890-9779

Registered Office

Nariman Bhavan, 8th Floor, 227, Backbay Reclamation,

Nariman Point, Bombay – 400 021

Tel.: (022) 2022166, 2022144, 2022362

Telex: 011-83391 FAG-IN

Telegram: FAGBEAR, Fax: (022) 2027022

Plant

Stratford, Ontario

Tel.: (519) 271-3230 · Fax: (519) 271-6074

Regional Sales Offices

& Warehouses

Truro, Nova Scotia

Tel.: (902) 895-9295 · Fax: (902) 893-2239

Dorval, Quebec

Tel.: (514) 422-1125 · Fax.: (514) 422-1020

Sudbury, Ontario

Tel.: (705) 560-0720 · Fax: (705) 560-5468

Winnipeg, Manitoba

Tel.: (204) 837-6651 · Fax: (204) 837-1541

Edmonton, Alberta

Tel.: (403) 465-0121 · Fax: (403) 469-1103

Burnaby, British Columbia

Tel.: (604) 433-4473 · Fax: (604) 433-7259

Rolling Bearing Damage

Recognition of damage and bearing
inspection

Publ. No. WL 82 102/2 EC

Head Office
FAG Bearings Limited
5965 Coopers Avenue,
Mississauga, Ontario, Canada L4Z 1R9
Tel. (905) 890-9770
Fax (905) 890-9779

Rolling Bearing Damage

Recognition of damage and bearing inspection

Every care has been taken to ensure the correctness of the information contained in this book but no liability can be accepted for any errors or omissions.

We reserve the right to make changes in the interest of technical progress.

Rolling Bearing Damage

Recognition of damage and bearing inspection

FAG

Rolling Bearings

FAG Australia Pty Ltd

Publ. No. WL 82 102/2 EF



Contact Partners for Technical Advice and Sales

FAG AUSTRALIA PTY LTD

Head office

FAG AUSTRALIA PTY LTD
Tel. (02) 452-1000
Telefax. (02) 452-4242

Branch

FAG New Zealand
6 Te Apunga Place
Mt. Wellington, Auckland
New Zealand

Postal address:

FAG New Zealand
Private Bag 94304
Pakuranga, Auckland
New Zealand
Tel: (09) 276-7744
Telefax: (09) 276-3399

Australian Distributors

Associated World Bearings
Western Australia
Tel: (09) 458 6400
Telefax: (09) 351 8160

Bearing Technics Webster Pty Ltd
NSW
Tel: (02) 681 5288
Telefax: (02) 681 5587

North Queensland Bearings Pty Ltd
Queensland
Tel: (070) 51 2711
Telefax: (070) 51 9583

Rolling Bearings Co. Pty Ltd
Victoria
Tel: (03) 553 1811
Telefax: (03) 553 3868

Rolling Bearings (Tasmania) Pty Ltd
Tasmania
Tel: (004) 24 6711
Telefax: (004) 24 9476

Webster Bearings & Engineering Supplies
Northern Territory
Tel: (089) 47 0240
Telefax: (089) 47 0371

Webster Bearings & Engineering Supplies
Queensland
Tel: (07) 852 1362
Telefax: (07) 252 4772

Webster Bearings & Engineering Supplies
Tasmania
Tel: (002) 38 0200
Telefax: (002) 34 4098

Webster Southern Bearings
South Australia
Tel: (08) 346 8433
Telefax: (08) 346 6588

New Zealand Distributors

Bay Engineers Supplies Ltd
Mt. Maunganui
Tel: (07) 575 5059
Telefax: (07) 575 2231

Bay Engineers Supplies Ltd
Auckland
Tel: (09) 273 9690
Telefax: (09) 273 9670

F. J. Farrell Limited
Hamilton
Tel: (07) 839 5123
Telefax: (07) 839 1339

General Machinery
Wanganui
Tel: (06) 345 8333
Telefax: (06) 345 5349

Mana Bearing Supplies
Porirua
Tel: (04) 237 4754
Telefax: (04) 237 9421

Wilson Brothers Limited
Christchurch
Tel: (03) 338 8533
Telefax: (03) 338 8518

Wilson Brothers Limited
Dunedin
Tel: (03) 477 8565
Telefax: (03) 477 2659

Wilson Brothers Limited
Invercargill
Tel: (03) 218 9076
Telefax: (03) 218 9801

Rolling Bearing Damage

Recognition of damage and bearing
inspection

Publ. No. WL 82 102/2 EF

FAG Australia Pty Ltd
4 Aquatic Drive · Frenchs Forest NSW 2086
P.O. Box 234 · Forestville NSW 2087
Tel. (02) 452 1000 · Fax (02) 452 4242

Rolling Bearing Damage

Recognition of damage and bearing inspection

Every care has been taken to ensure the correctness of the information contained in this book but no liability can be accepted for any errors or omissions.

We reserve the right to make changes in the interest of technical progress.

Rolling Bearing Damage

Recognition of damage and bearing inspection

FAG

Rolling Bearings

FAG Bearings Corporation

Publ. No. WL 82 102/2 ED



Rolling Bearing Damage

Recognition of damage and bearing
inspection

Publ. No. WL 82 102/2 ED

FAG Bearings Corporation

200 Park Avenue · P. O. Box 1933
Danbury, Connecticut 06813-1933
Tel. (203) 790-5474 · Fax (203) 830 8171

