



# Single Axis Robot

Technical Information

# Single Axis Robot

## Technical Information

**KK Type**  
P. 01



**KS05 Type**  
P. 19



**KS Type**  
P. 23



**KA Type**  
P. 27



# Single Axis Robot

## KK Type

### 1.1 Features

- Easy for system design, installation and maintenance
- Compact and lightweight
- High accuracy
- High stiffness
- Complete selection of accessories for most any application.

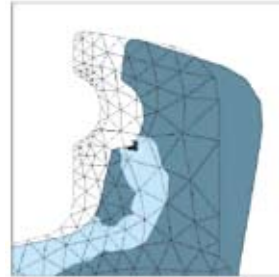

The structure is designed for high stiffness and lightweight. The FEM analysis is shown as follows:

The KK Linear Stage is features a slider actuated by a motor-driven ballscrew and guided by a linear guideway with a U-shape rail. The slider acts as the ballscrew's nut and the guideway's block.

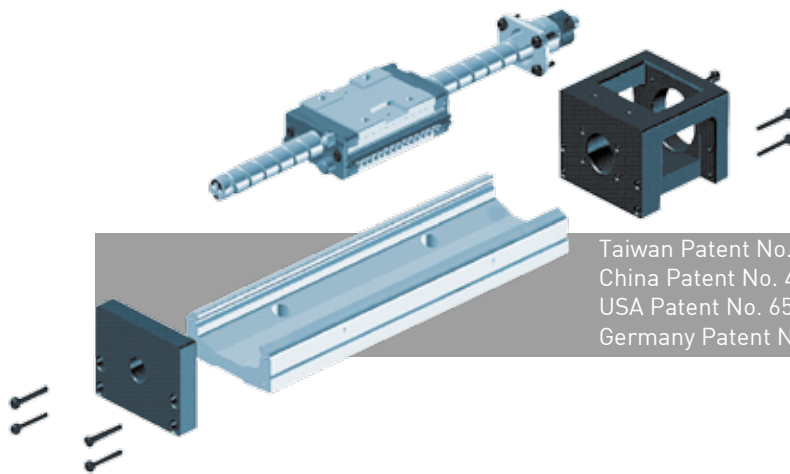

Taiwan Patent No. 183022  
China Patent No. 481446  
USA Patent No. 6584868  
Germany Patent No. 20117489.8

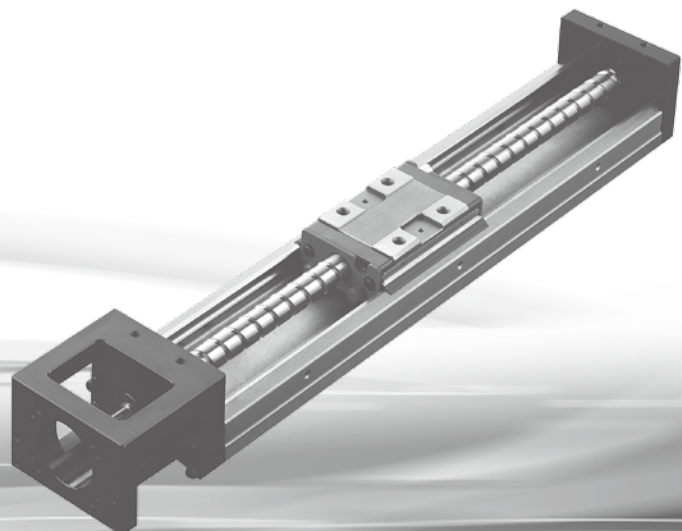

## 1.2 Model Number of KK Type

Example: KK6010P-E-400-E-A-2-E-F0-C-S0

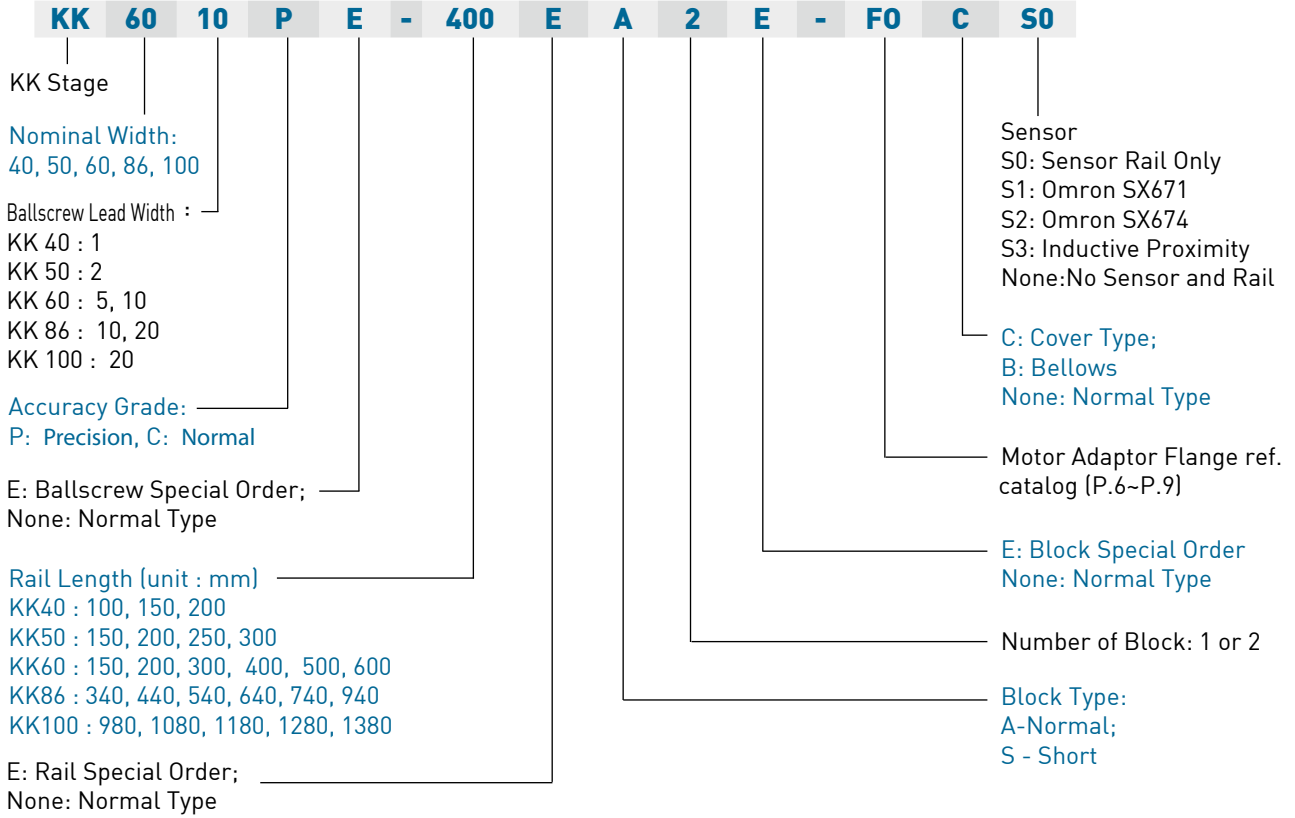

### 1.3 Maximum Speed Limit

Model	Ballscrew Lead (mm)	Rail Length (mm)	Speed (mm/sec)	
			Precision	Normal
KK40	01	100	190	190
		150	190	190
		200	190	190
KK50	02	150	270	270
		200	270	270
		250	270	270
		300	270	270
KK60	05	150	550	390
		200	550	390
		300	550	390
		400	550	390
		500	550	390
		600	340	340
	10	150	1100	790
		200	1100	790
		300	1100	790
		400	1100	790
		500	1100	790
		600	670	670
KK86	10	340	740	520
		440	740	520
		540	740	520
		640	740	520
		740	740	520
		940	610	430
	20	340	1480	1050
		440	1480	1050
		540	1480	1050
		640	1480	1050
		740	1480	1050
		940	1220	870
KK100	20	980	1120	800
		1080	980	800
		1180	750	750
		1280	510	630
		1380	440	530

## 1.4 Specifications

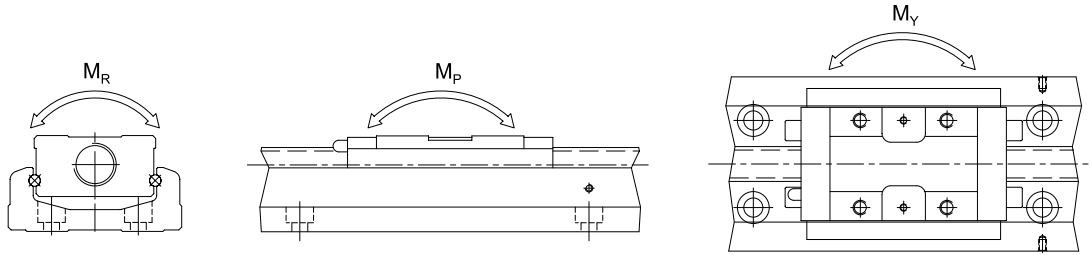

		KK4001		KK5002		KK6005		KK6010		KK8610		KK8620		KK10020		
		Precision	Normal	Precision	Normal	Precision	Normal	Precision	Normal	Precision	Normal	Precision	Normal	Precision	Normal	
BallscREW	Nominal (mm)	8		8		12		15		20		20		20		
	Lead (mm)	1		2		5		10		10		20		20		
	Basic Dynamic load (N)	735	676	2136	1813	3744	3377	2410	2107	7144	6429	4645	4175	7046	4782	
	Basic Static Load (N)	1538	1284	3489	2910	6243	5625	3743	3234	12642	11387	7655	6889	12544	9163	
Guideway	Basic Dynamic Load Rating (N)	Block A	3920		8007		13230		31458		39200		-		-	
		Block S	-		-		7173		-		-		-		-	
	Basic Static Load Rating(N)	Block A	6468		12916		21462		50764		63406		-		-	
		Block S	-		-		11574		-		-		-		-	
	Allowable Static Moment $M_P$ (pitching)(N-m)	Block A1	33		116		152		622		960		-		-	
		Block A2	182		278		348		3050		4763		-		-	
		Block S1	-		-		72		-		-		-		-	
		Block S2	-		-		205		-		-		-		-	
	Allowable Static Moment $M_Y$ (yawing)(N-m)	Block A1	33		116		152		622		960		-		-	
		Block A2	182		278		348		3050		4763		-		-	
		Block S1	-		-		72		-		-		-		-	
		Block S2	-		-		205		-		-		-		-	
Allowable Static Moment $M_R$ (rolling)(N-m)	Block A1	81		222		419		1507		2205		-		-		
	Block A2	162		444		838		3014		4410		-		-		
	Block S1	-		-		241		-		-		-		-		
	Block S2	-		-		482		-		-		-		-		

## 1.5 Accuracy Grade

Unit : mm

Model	Rail Length	Repeatability		Accuracy		Running Parallelism		Starting Torque(N-cm)	
		Precision	Normal	Precision	Normal	Precision	Normal	Precision	Normal
KK40	100	±0.003	±0.01	0.020	-	0.010	-	1.2	0.8
	150								
	200								
KK50	150	±0.003	±0.01	0.020	-	0.010	-	4	2
	200								
	250								
	300								
KK60	150	±0.003	±0.01	0.020	-	0.010	-	15	7
	200								
	300								
	400								
	500	±0.003	±0.01	0.025	-	0.015	-	15	7
	600								
KK86	340	±0.003	±0.01	0.025	-	0.015	-	15	10
	440								
	540								
	640								
	740	±0.003	±0.01	0.030	-	0.020	-	17	10
	940								
KK100	980	±0.005	±0.01	0.035	-	0.025	-	17	12
	1080								
	1180	±0.005	±0.01	0.040	-	0.030	-	20	12
	1280								
	1380								

## 1.6 Motor and Motor Adaptor Flange

### 1.6.1 KK Type with Motor

#### Feature

- High performance and low cost
- Accuracy: 20 ~ 25 $\mu$ m (within 300mm)
- Repeatability:  $\pm$ 3 $\mu$ m (within 300mm)
- Max. speed: 30 ~ 120 mm/s
- Thrust force: 150 ~ 600 N
- Using P Grade Ballscrew

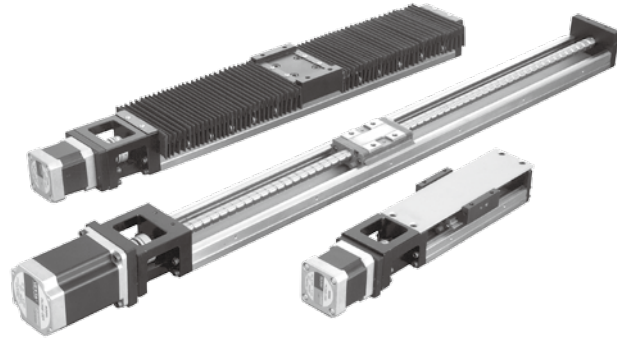

### Model Number of KK Type with Motor

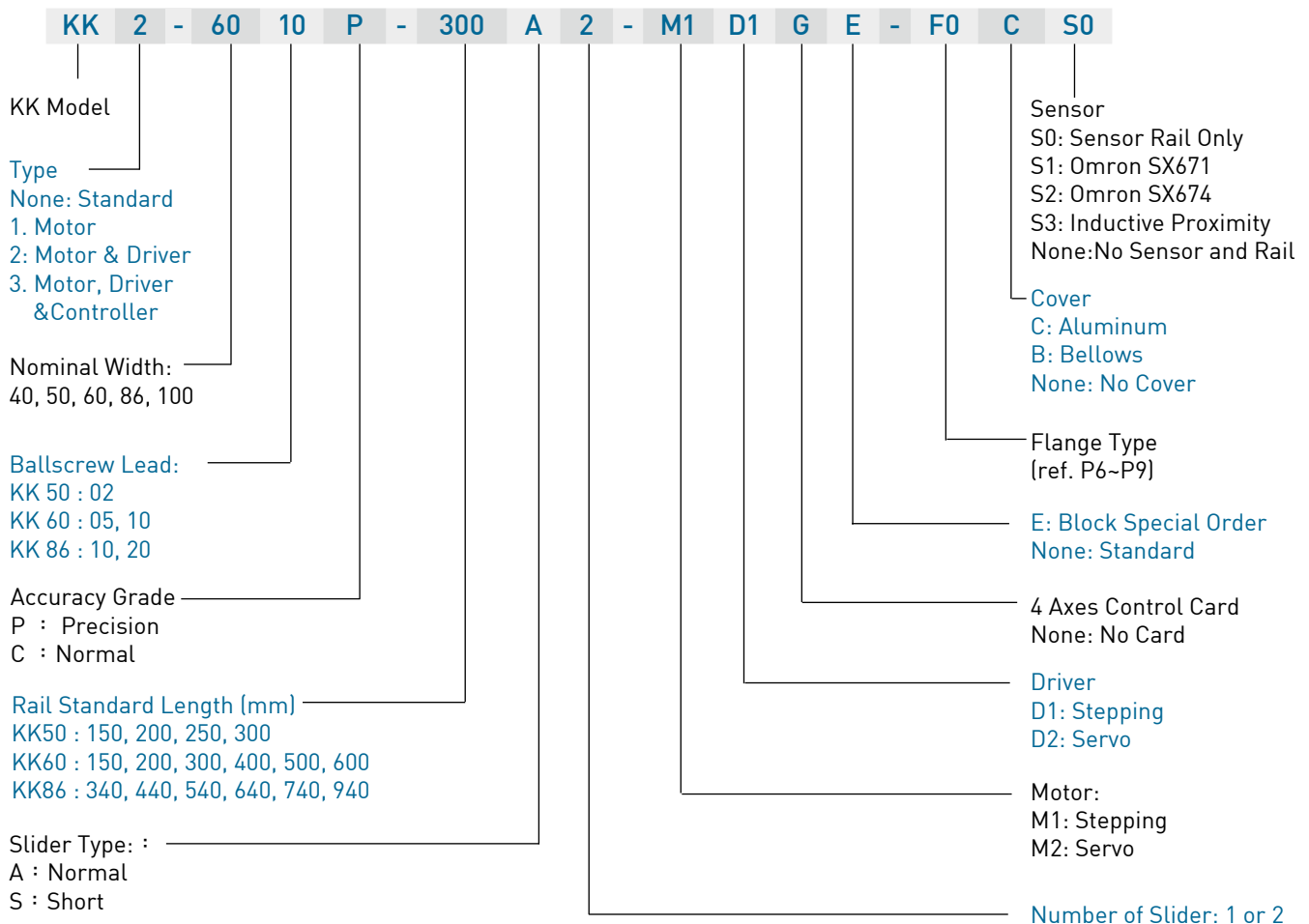



### 1.6.2 Motor and motor adaptor flange

Motor		Model	KK 40	KK 50	KK 60	KK 86	KK 100
AC Servo Motor	Panasonic	MSM3AZ(30W) MSM5AZ(50W) MSM01(100W)	F2	F2	F2	F3	
		MSM02(200W) MSM04(400W)				F1	
		MSM08(750W)				F4	F2
	MHI	HC-PQ033(30W) HC-PQ053(50W) HC-PQ13(100W)	F1	F1	F1	F2	
		HC-KFS053(50W) HC-KFS13(100W)	F1	F1	F1	F2	
		HC-KFS23(200W) HC-KFS43(400W)				F0	F0
		HC-MF73(750W)					F1
	Yaskawa	SGM-A3(30W) SGM-A5(50W) SGM-01(100W)		F1	F1	F2	
		SGM-02(200W) SGM-04(400W)				F0	F0
		SGM-08(750W)					F1
	Nema17			F3	F3	F5	
	Nema23				(F-E2)	F4	F6
	Nema34						F4
Stepping Motor	VEXTA	PK24	F3	F3	F5		
		PK26		(F-E2)	F4	F6	
		PK29					F4
		PK54		F3	F5		
		PK56		(F-E1)		F5	
		PK59					F3
	Nema17			F3	F3	F5	
	Nema23				(F-E2)	F4	F6
	Nema34						F4

### 1.6.3 Motor Adaptor Flange

#### KK40

Motor Adaptor Flange F0

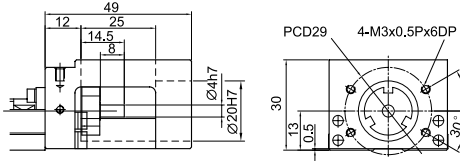

Motor Adaptor Flange F2

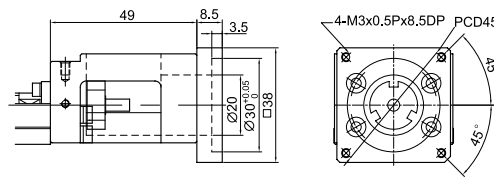

Motor Adaptor Flange F1

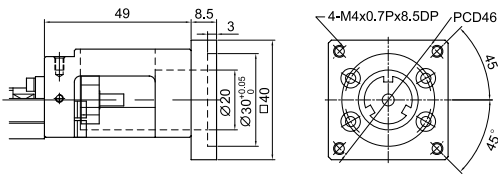

Motor Adaptor Flange F3

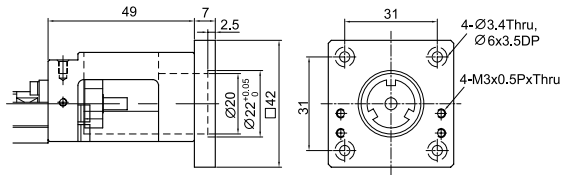

#### KK50

Motor Adaptor Flange F0

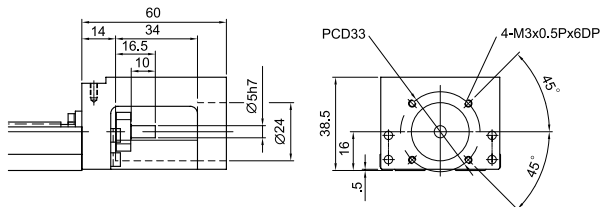

Motor Adaptor Flange F2

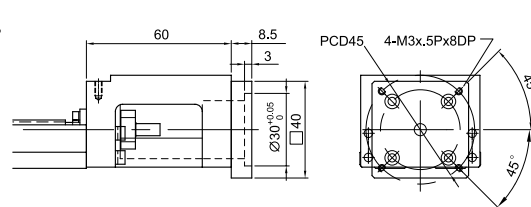

Motor Adaptor Flange F1

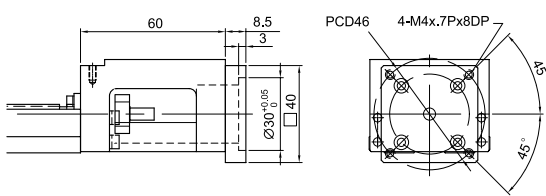

Motor Adaptor Flange F3

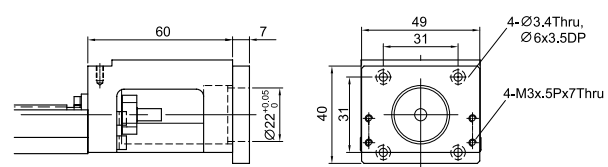

#### KK60

Motor Adaptor Flange F0

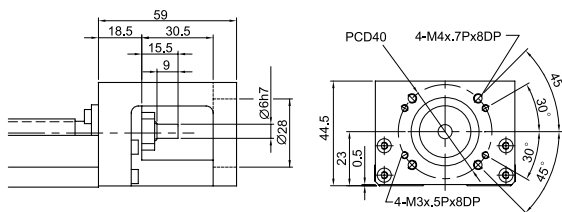

Motor Adaptor Flange F3

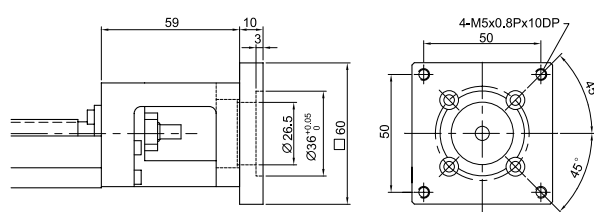

Motor Adaptor Flange F1

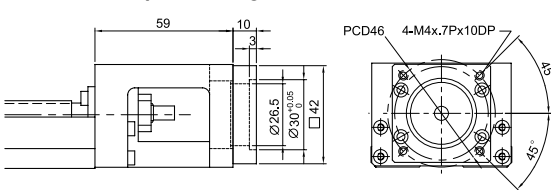

Motor Adaptor Flange F4

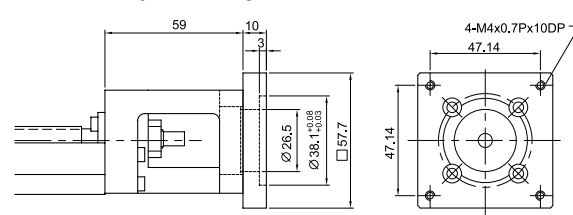

Motor Adaptor Flange F2

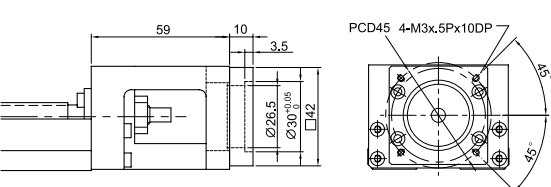

Motor Adaptor Flange F5

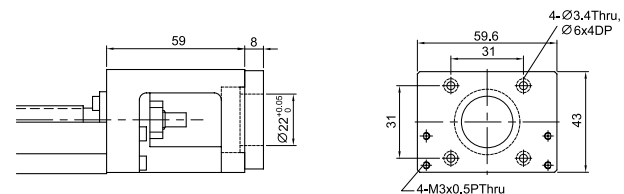

## KK86

Motor Adaptor Flange F0

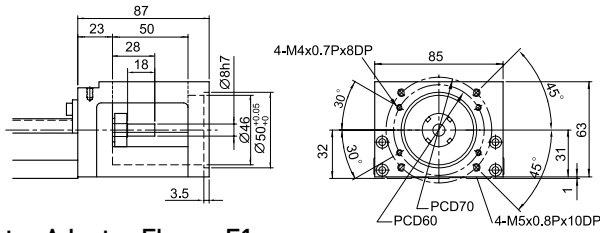

Motor Adaptor Flange F1

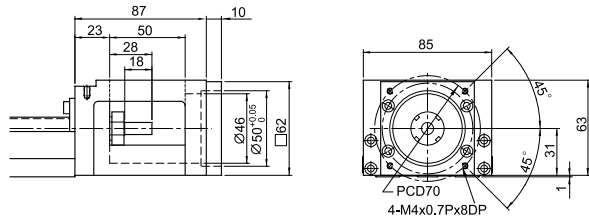

Motor Adaptor Flange F4

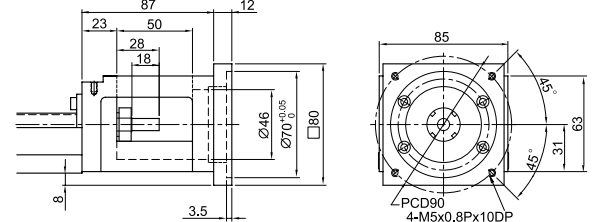

Motor Adaptor Flange F2

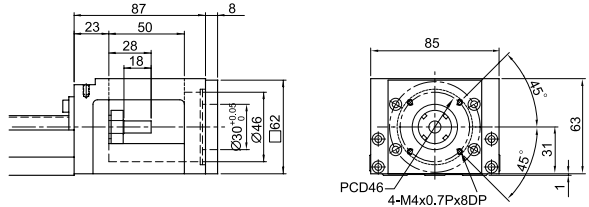

Motor Adaptor Flange F5

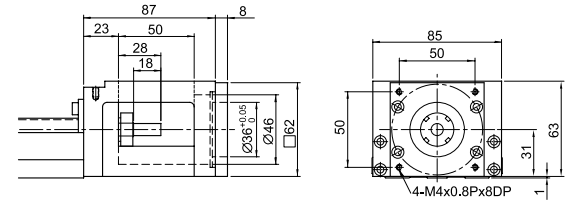

Motor Adaptor Flange F3

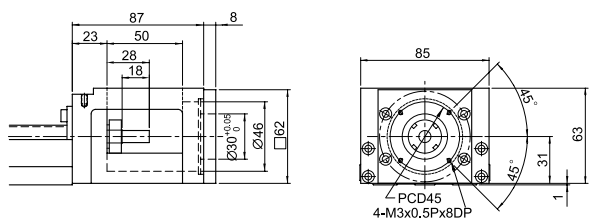

Motor Adaptor Flange F6

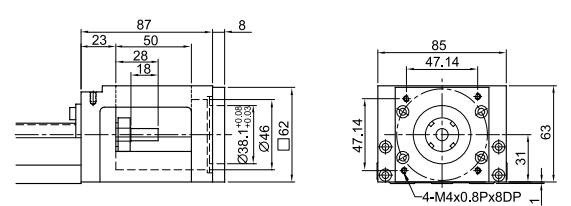

## KK100

Motor Adaptor Flange F0

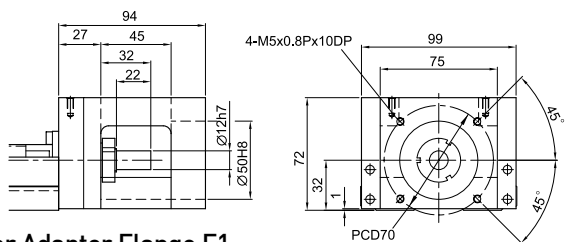

Motor Adaptor Flange F1

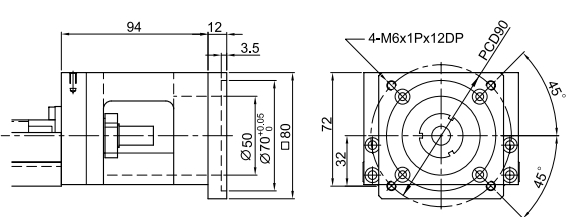

Motor Adaptor Flange F3

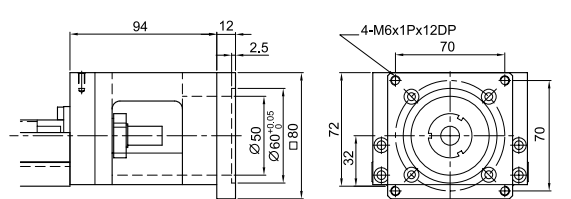

Motor Adaptor Flange F2

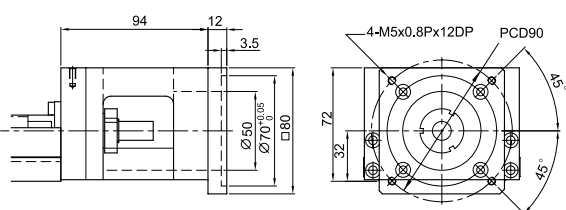

Motor Adaptor Flange F4

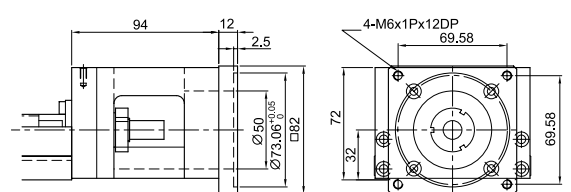

## 1.7 Optional Accessories

### 1.7.1 Bellows

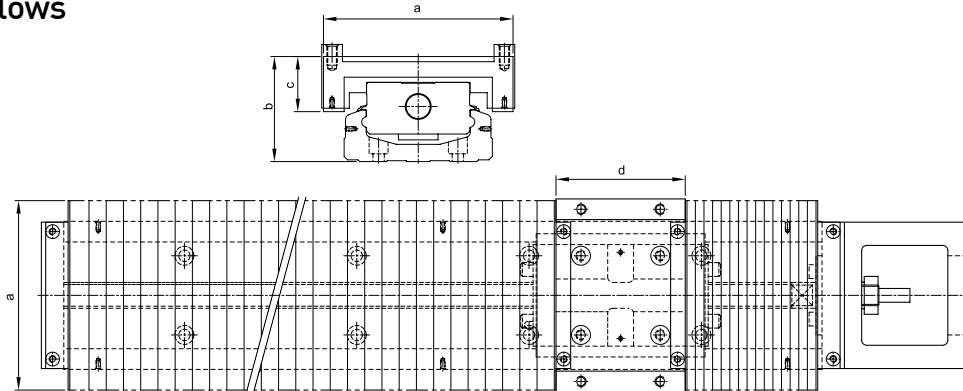

Unit : mm

Nominal Width	Rail Length	Stroke	Min.	Max.	a	b	c	d
KK60	150	56	16	80	84	45.5	24	54
	200	106	20	126				
	300	166	40	206				
	400	234	56	290				
	500	306	70	376				
	600	366	90	456				
KK86	340	188	36	224	110	61	32	75
	440	260	50	310				
	540	336	62	398				
	640	408	76	484				
	740	480	90	570				
	940	640	110	750				

### 1.7.2 Switch

Switch rail

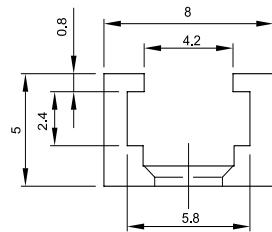

Switch

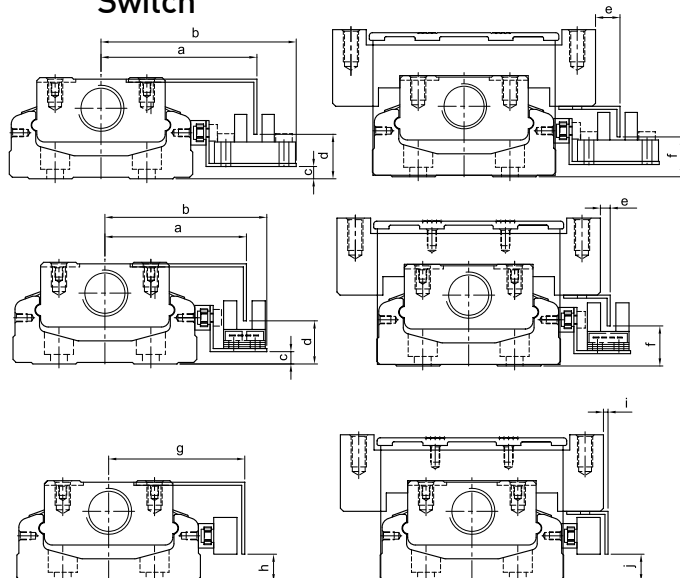

Nominal Width	a	b	c	d	e	f
KK50	45.5	59	1	10	15	11
KK60	51	63.8	4	14.5	8	13
KK86	63.5	76.7	8	18	8	18
KK100	71	84	10	20	9	20

Switch 1 : Omron EE-SX671

Nominal Width	a	b	c	d	e	f
KK50	41.3	48	1	10.5	10.2	11
KK60	46.2	52.8	4	14	3.2	13
KK86	59	65.7	8	18	3	18
KK100	66	73	10	20	4.2	20

Switch 2 : Omron EE-SX674

Nominal Width	g	h	i	j
KK50	39.5	5.7	7	19.5
KK60	44.5	9	2	9
KK86	57	13	1	13
KK100	64.5	15	2.5	15

Switch 3, 4 : SUNX GL-12F, GL-N12F-PX10

## 1.8 Life Calculations

Three main components of the KK Linear Stage are guideway, ballscrew and bearing. The calculation formulas of their life are shown as follows:

### 1.8.1 Guideway

$$L = \left( \frac{f_t}{f_w} \cdot \frac{C}{P_n} \right)^3 \times 50 \text{ km}$$

$L$  : Life Rating (km)       $C$  : Basic Dynamic Load Rating (N)  
 $f_t$  : Contact Coefficient (ref. Table 1)       $P_n$  : Calculating Loading (N)  
 $f_w$  : Loading Coefficient (ref. Table 2)

Table 1

Block type	Contact Coefficient $f_t$
A1, S1	1.0
A2, S2	0.81

Table 2

Operating Condition		Loading Coefficient $f_w$
Thrust and Vibration	Velocity (V)	
No Thrust	$V < 15\text{m/min}$	1.0 ~ 1.5
Low Vibration	$15\text{min} < V < 60\text{m/min}$	1.5 ~ 2.0
High Vibration	$V > 60\text{m/min}$	2.0 ~ 3.5

### 1.8.2 Ballscrew and Bearing

$$L = \left( \frac{1}{f_w} \cdot \frac{C_a}{P_{a,n}} \right)^3 \times 10^6 \text{ rev}$$

$L$  : Life Rating (rev.)       $C_a$  : Basic Dynamic Load Rating (N)  
 $f_w$  : Loading Coefficient (ref. Table 2)       $P_{a,n}$  : Axial Loading (N)

## 1.9 Lubrication

Replenishing the grease every 100km

Number of Block 1

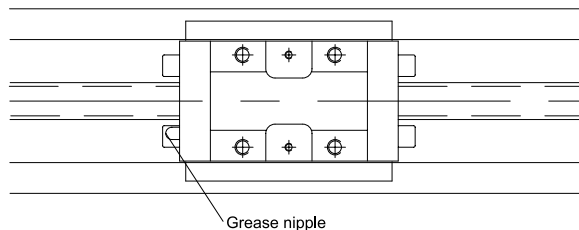

Number of Block 2

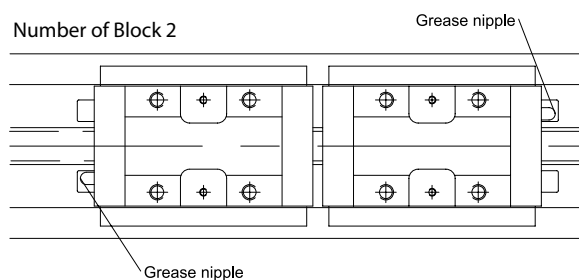

## 1.10 Dimension

### 1.10.1 Without cover

#### KK40

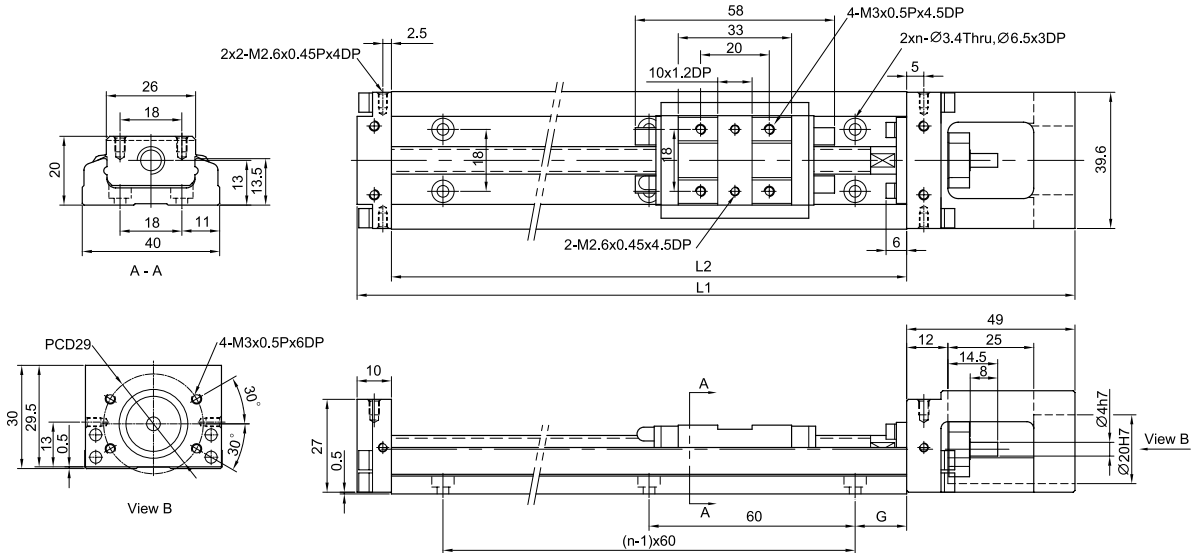

Rail Length L2 (mm)	Total Length L1 (mm)	Maximum Stroke (mm)		G (mm)	n (mm)	Mass (kg)	
		A1 Block	A2 Block			A1 Block	A2 Block
100	159	36	-	20	2	0.48	-
150	209	86	34	15	3	0.6	0.67
200	259	136	84	40	3	0.72	0.79

#### KK50

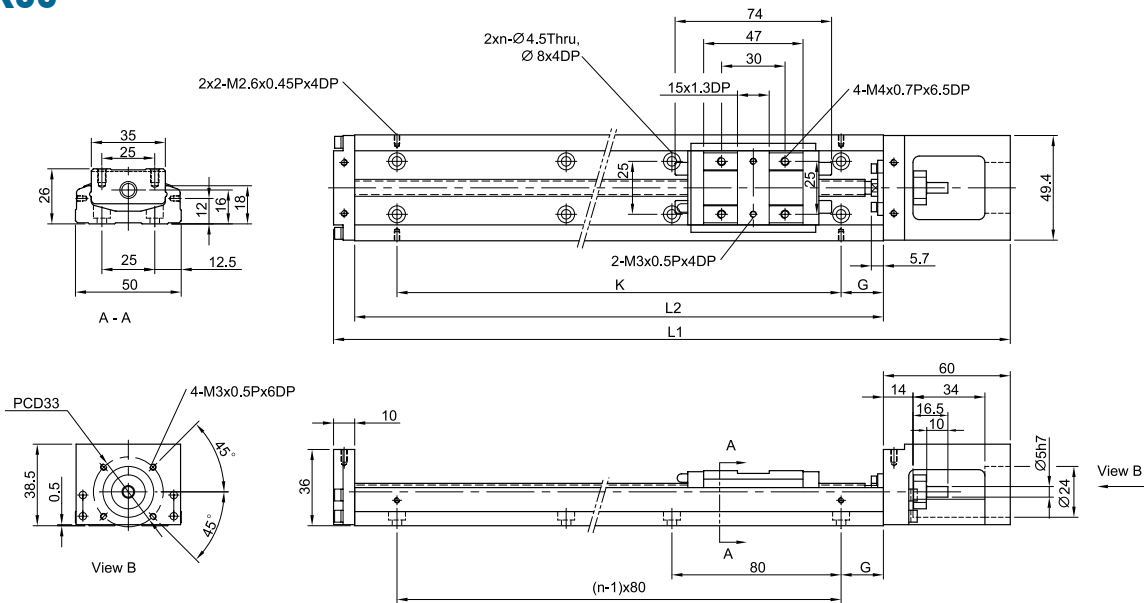

Rail Length L2 (mm)	Total Length L1 (mm)	Maximum Stroke (mm)		G (mm)	K (mm)	n	Mass (kg)	
		A1 Block	A2 Block				A1 Block	A2 Block
150	220	70	-	35	80	2	1	-
200	270	120	55	20	160	3	1.2	1.4
250	320	170	105	45	160	3	1.4	1.6
300	370	220	155	30	240	4	1.6	1.8

### KK60 (Standard)

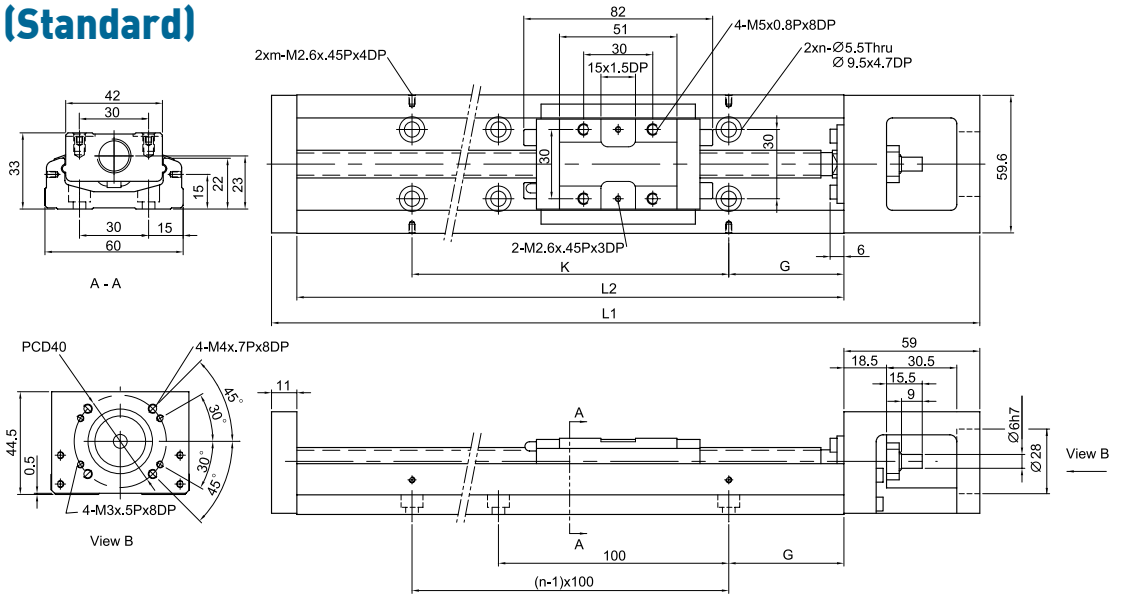

Rail Length L2 (mm)	Total Length L1 (mm)	Maximum Stroke (mm)		G (mm)	K (mm)	n	m	Mass (kg)	
		A1 Block	A2 Block					A1 Block	A2 Block
150	220	60	-	25	100	2	2	1.5	-
200	270	110	-	50	100	2	2	1.8	-
300	370	210	135	50	200	3	2	2.4	2.7
400	470	310	235	50	100	4	4	3	3.3
500	570	410	335	50	200	5	3	3.6	3.9
600	670	510	435	50	100	6	6	4.2	4.6

### KK60 (Light Duty)

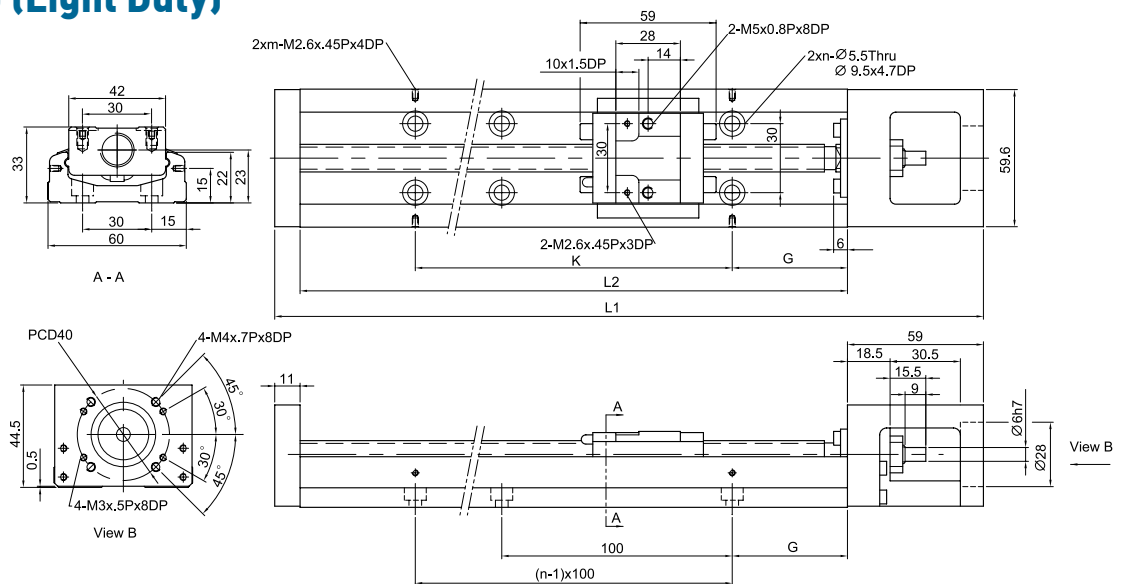

Rail Length L2 (mm)	Total Length L1 (mm)	Maximum Stroke (mm)		G (mm)	K (mm)	n	m	Mass (kg)	
		S1 Block	S2 Block					S1 Block	S2 Block
150	220	85	34	25	100	2	2	1.4	1.6
200	270	135	184	50	100	2	2	1.7	1.9
300	370	235	184	50	200	3	2	2.3	2.5
400	470	335	284	50	100	4	4	2.9	3.1
500	570	435	384	50	200	5	3	3.5	3.7
600	670	535	484	50	100	6	6	4.1	4.3

### KK86

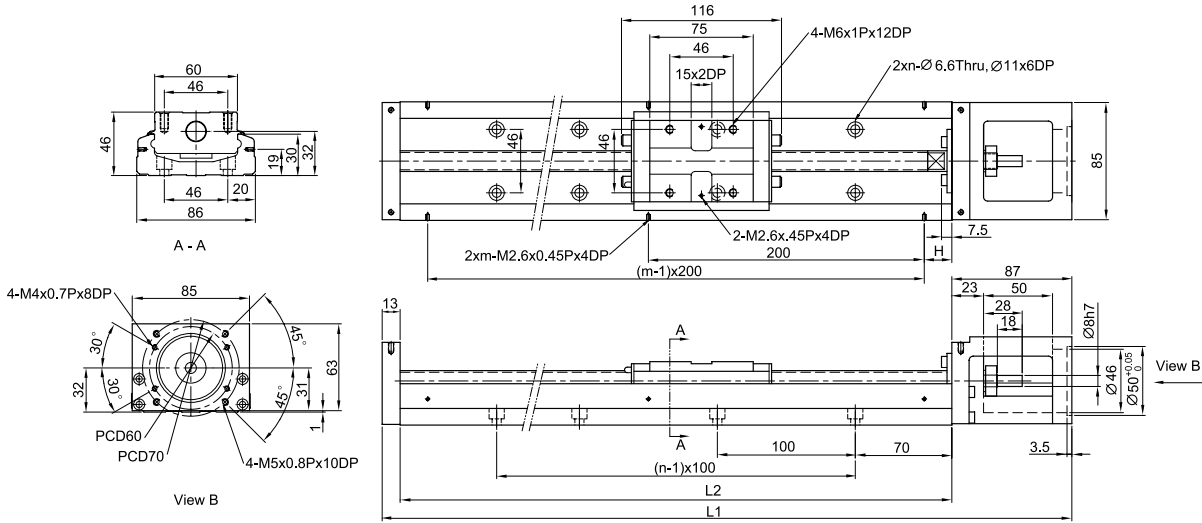

Rail Length L2 (mm)	Total Length L1 (mm)	Maximum Stroke (mm)		H (mm)	n	m	Mass (kg)	
		A1 Block	A2 Block				A1 Block	A2 Block
340	440	210	100	70	3	2	5.7	6.5
440	540	310	200	20	4	3	6.9	7.7
540	640	410	300	70	5	3	8.0	8.8
640	740	510	400	20	6	4	9.2	10.0
740	840	610	500	70	7	4	10.4	11.2
940	1040	810	700	70	9	5	11.6	12.4

### KK100

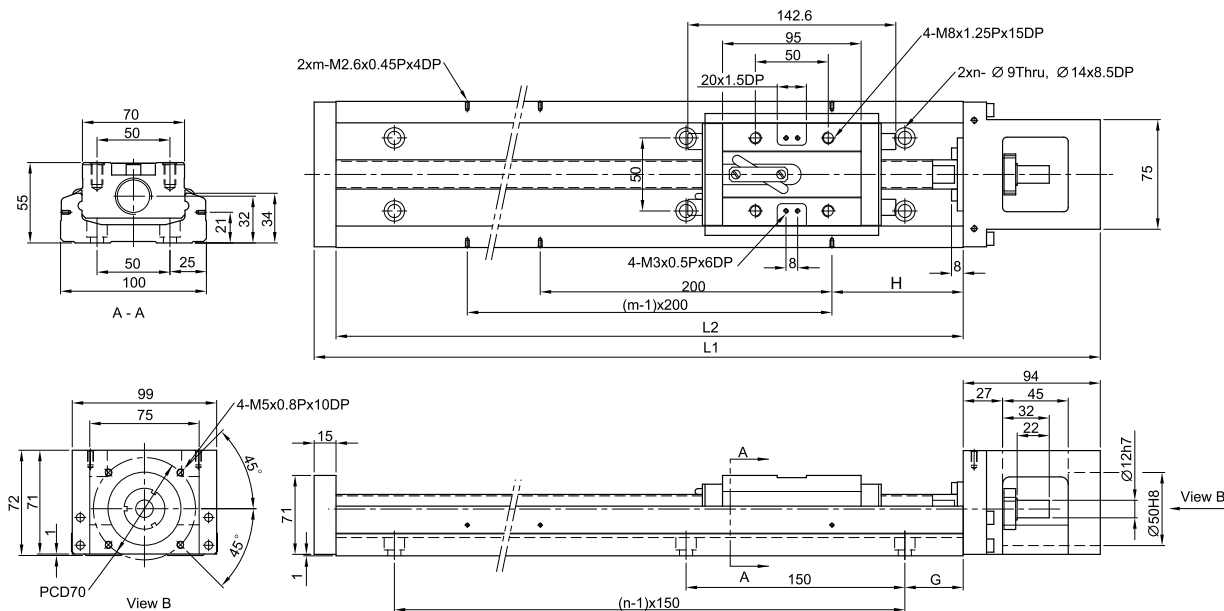

Rail Length L2 (mm)	Total Length L1 (mm)	Maximum Stroke (mm)		G (mm)	H (mm)	n	m	Mass (kg)	
		A1 Block	A2 Block					A1 Block	A2 Block
980	1089	828	700	40	90	7	5	18.6	20.3
1080	1189	928	800	15	40	8	6	20.3	22.0
1180	1289	1028	900	65	90	8	6	22.0	23.7
1280	1389	1128	1000	40	40	9	7	23.6	25.3
1380	1489	1228	1100	15	90	10	7	25.3	27.0



### 1.10.2 With cover

#### KK40

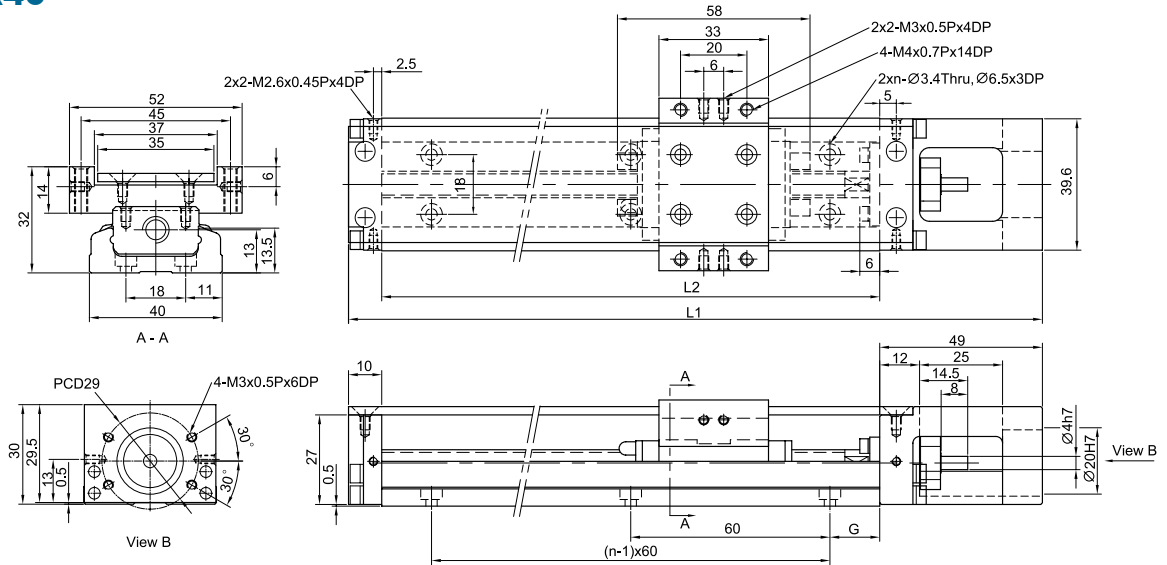

Rail Length L2 (mm)	Total Length L1 (mm)	Maximum Stroke (mm)		G (mm)	n	Mass (kg)	
		A1 Block	A2 Block			A1 Block	A2 Block
100	159	36	-	20	2	0.55	-
150	209	86	34	15	3	0.68	0.76
200	259	136	84	40	3	0.82	0.89

#### KK50

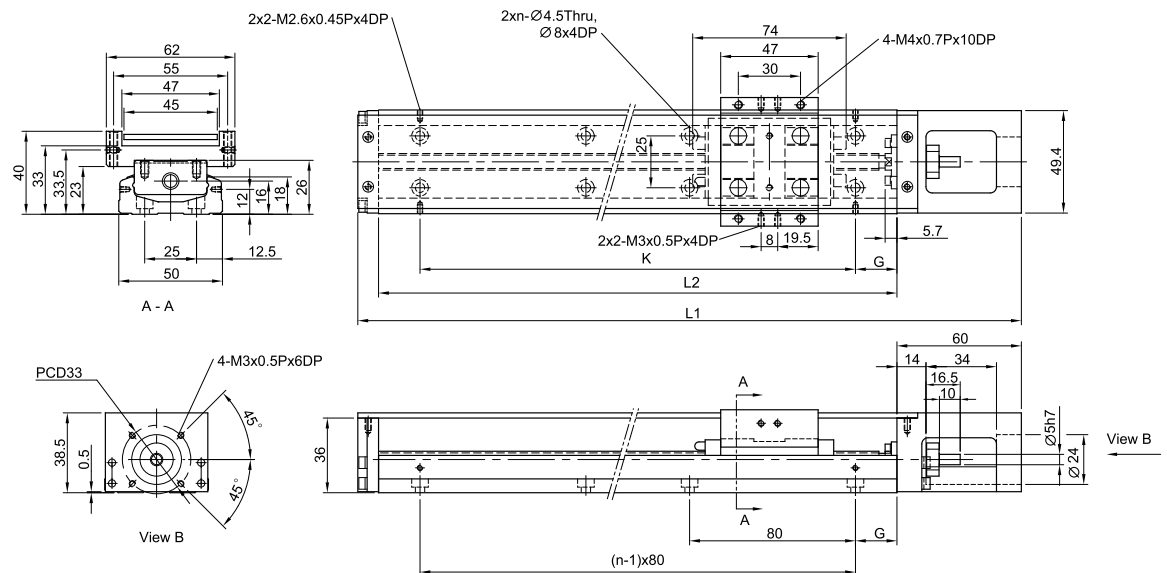

Rail Length L2 (mm)	Total Length L1 (mm)	Maximum Stroke (mm)		G (mm)	K (mm)	n	Mass (kg)	
		A1 Block	A2 Block				A1 Block	A2 Block
150	220	70	-	35	80	1.1	-	
200	270	120	55	20	160	1.3	1.5	
250	320	170	105	45	160	1.6	1.8	
300	370	220	155	30	240	1.8	2.0	

## KK60 (Standard)

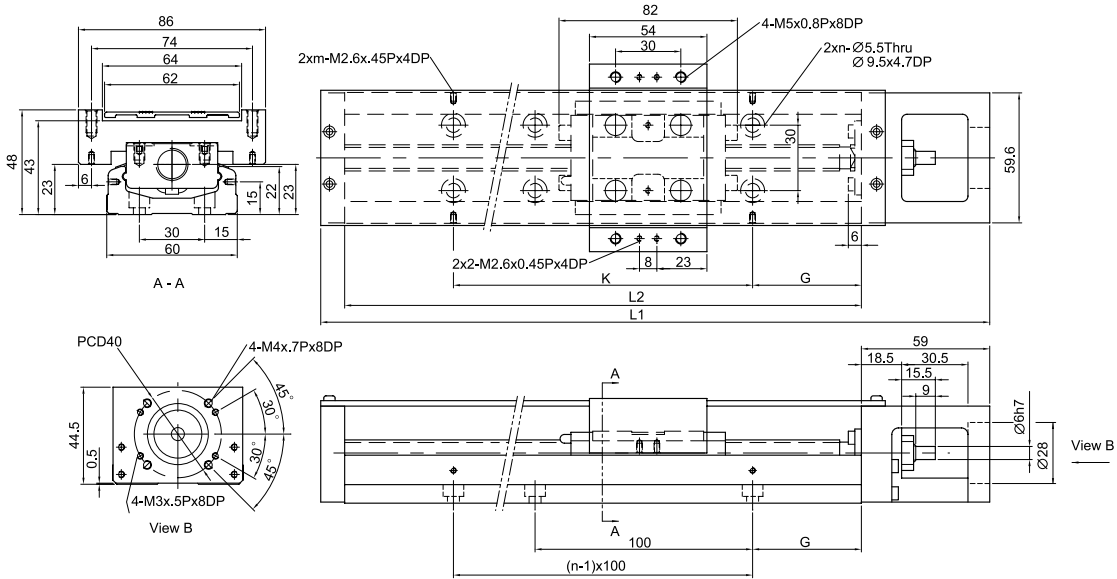

Rail Length L2 (mm)	Total Length L1 (mm)	Maximum Stroke (mm)		G (mm)	K (mm)	n	m	Mass (kg)	
		A1 Block	A2 Block					A1 Block	A2 Block
150	220	60	-	25	100	2	2	1.7	-
200	270	110	-	50	100	2	2	2.1	-
300	370	210	135	50	200	3	2	2.7	3.0
400	470	310	235	50	100	4	4	3.3	3.6
500	570	410	335	50	200	5	3	3.9	4.2
600	670	510	435	50	100	6	6	4.6	5.0

## KK60 (Light Duty)

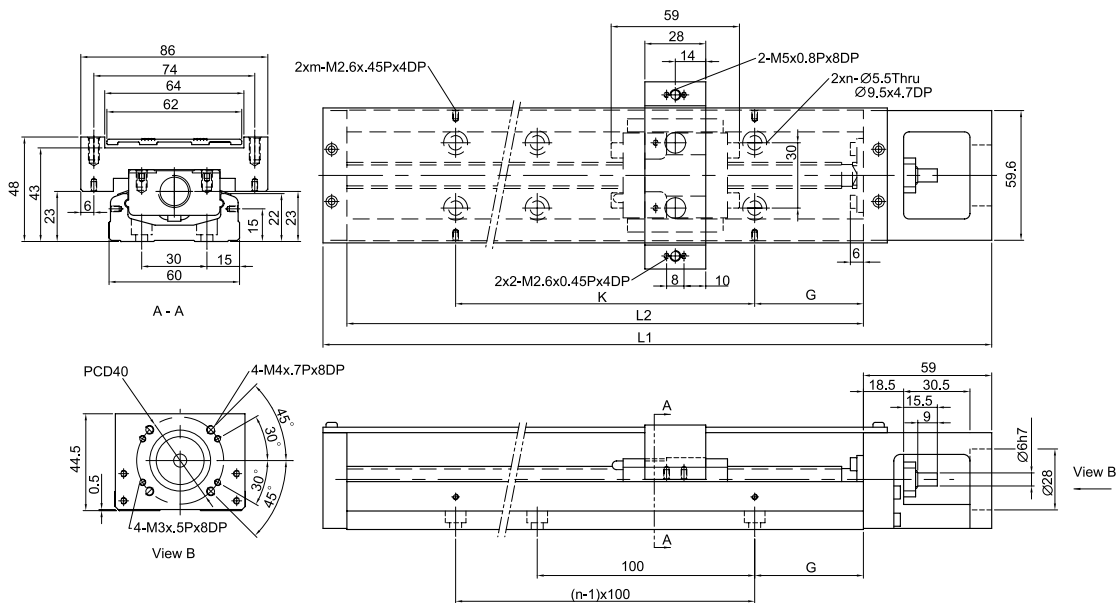

Rail Length L2 (mm)	Total Length L1 (mm)	Maximum Stroke (mm)		G (mm)	K (mm)	n	m	Mass (kg)	
		S1 Block	S2 Block					S1 Block	S2 Block
150	220	85	34	25	100	2	2	1.6	1.8
200	270	135	184	50	100	2	2	1.9	2.1
300	370	235	184	50	200	3	2	2.5	2.7
400	470	335	284	50	100	4	4	3.1	3.3
500	570	435	384	50	200	5	3	3.7	3.9
600	670	535	484	50	100	6	6	4.4	4.6

### KK86

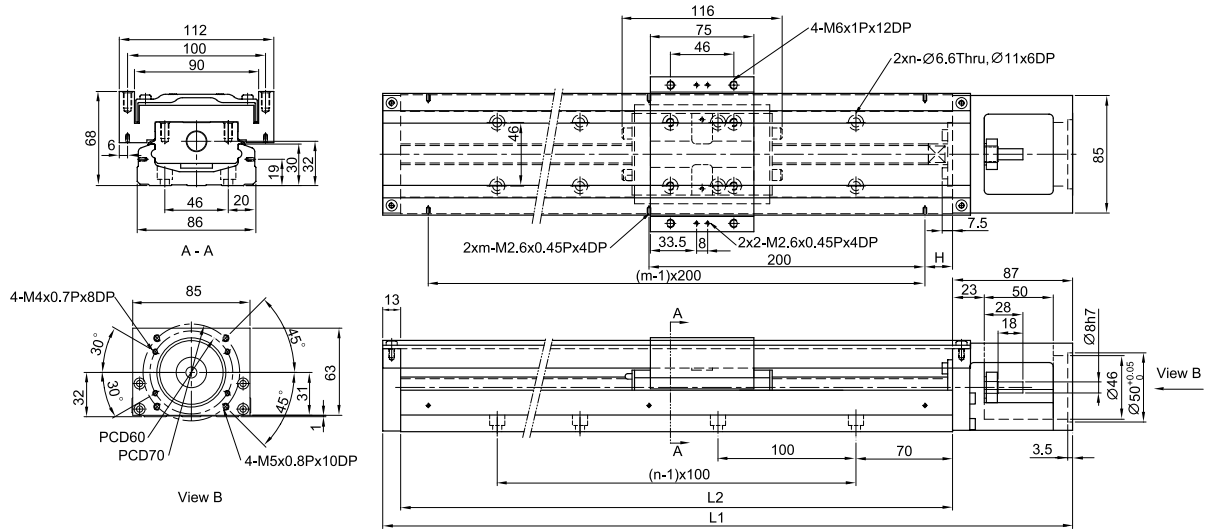

Rail Length L2 (mm)	Total Length L1 (mm)	Maximum Stroke (mm)		H (mm)	n	m	Mass (kg)	
		A1 Block	A2 Block				A1 Block	A2 Block
340	440	210	100	70	3	2	6.5	7.3
440	540	310	200	20	4	3	7.8	8.6
540	640	410	300	70	5	3	9.0	9.8
640	740	510	400	20	6	4	10.3	11.3
740	840	610	500	70	7	4	11.6	12.4
940	1040	810	700	70	9	5	13.0	13.8

### KK100

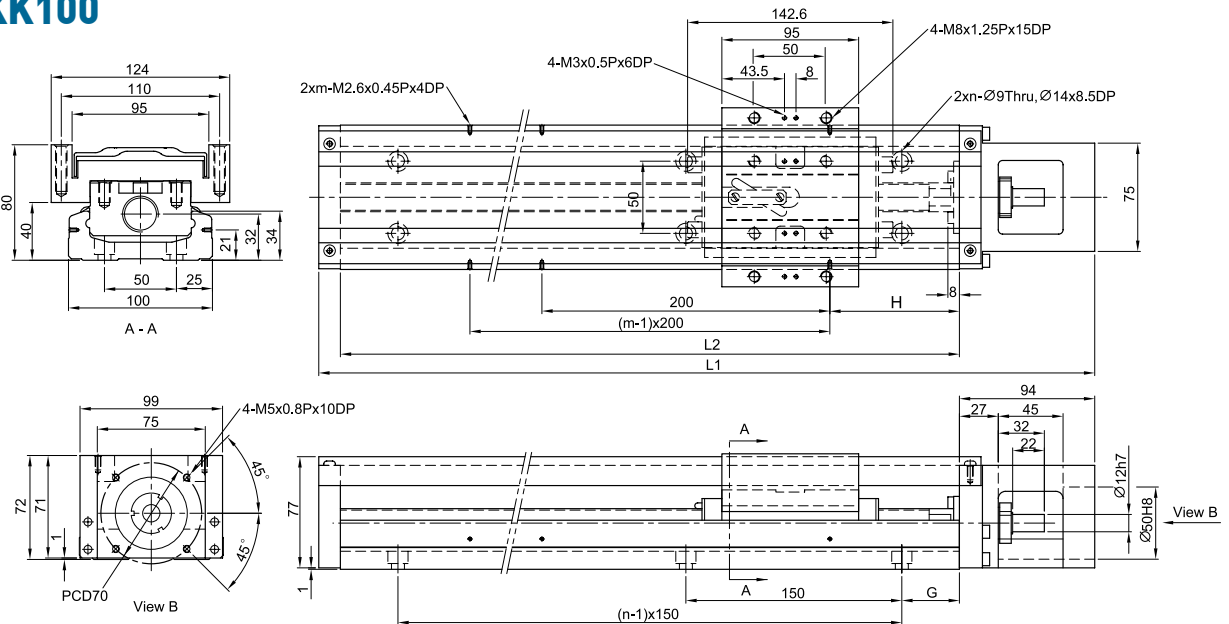

Rail Length L2 (mm)	Total Length L1 (mm)	Maximum Stroke (mm)		G (mm)	H (mm)	n	m	Mass (kg)	
		A1 Block	A2 Block					A1 Block	A2 Block
980	1089	828	700	40	90	7	5	20.4	22.1
1080	1189	928	800	15	40	8	6	22.2	23.9
1180	1289	1028	900	65	90	8	6	24.0	25.7
1280	1389	1128	1000	40	40	9	7	25.7	27.4
1380	1489	1228	1100	15	90	10	7	27.5	29.2



# Single Axis Robot

## KS05 Type

### 2.1 Features

- Compact and lightweight
- Reasonable price
- Stainless Covers
- High repeatability  $\pm 0.01\text{mm}$
- Dust proof
- Relative motion for sliders (double sliders)
- Easy for system maintenance

### 2.2 Applications

- FPD industry
- Semiconductor
- Medical applications
- FPD glass transfer & alignment
- Inspection & Testing equipment



### 2.3 Model Number of KS05 Type

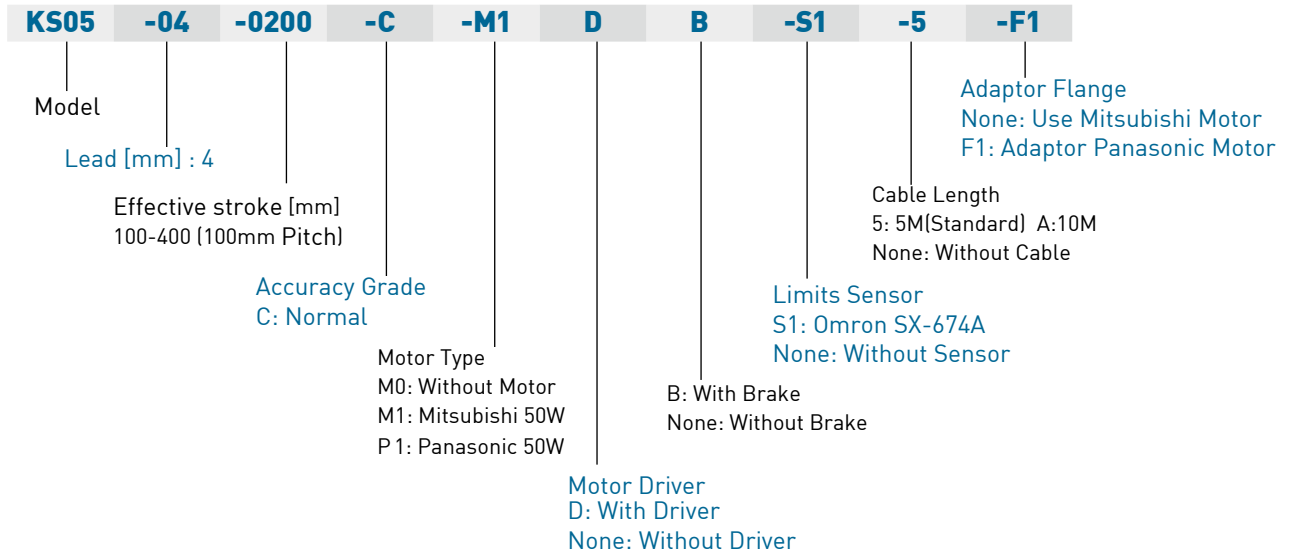

### 2.4 Dimensions for KS05 (Single slider)

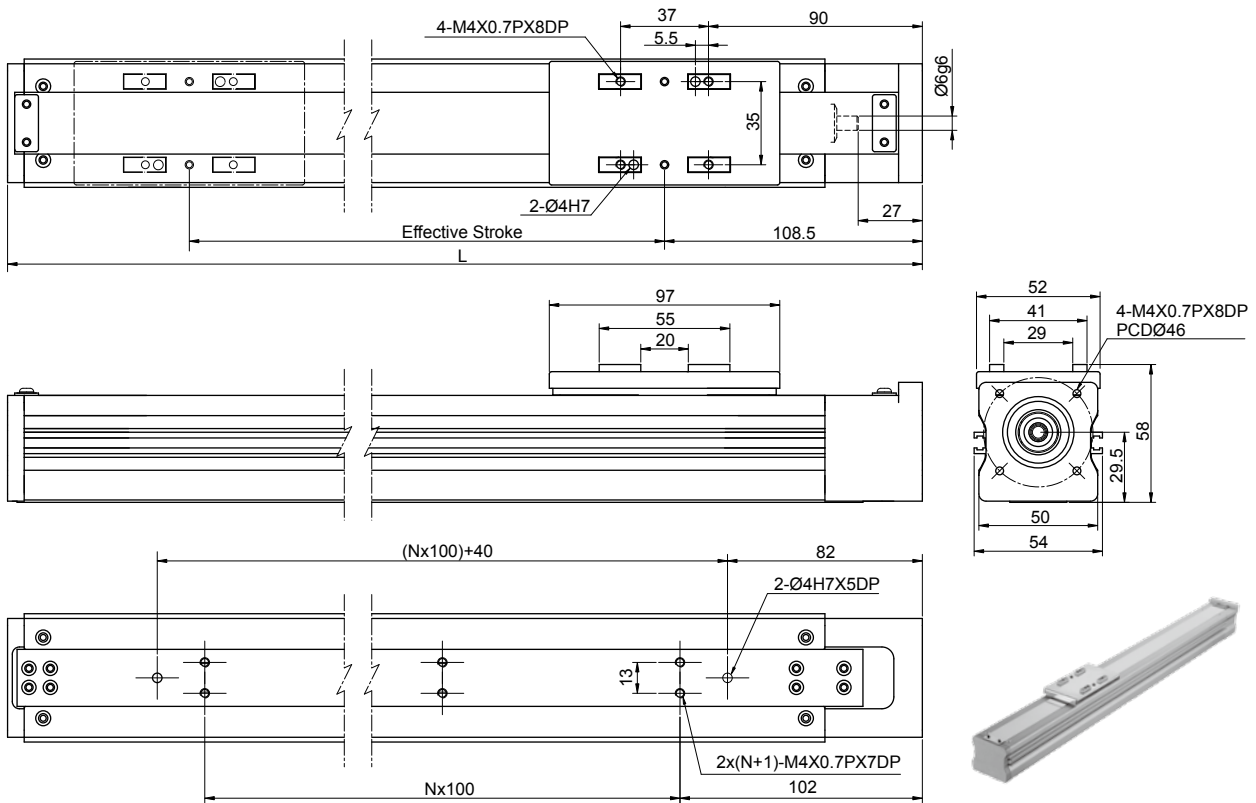

Effective Stroke (mm)	Total Length (mm)	N	Weight (kg)	Max. Speed (mm/sec)	AC Servo Motor Output (W)	50
100	285	1	1.4	200	Repeatability (mm)	Grade C: ±0.02
200	385	2	1.7	200	Ball screw lead (mm)	4
300	485	3	2	200	Stroke (mm)	100~400 (100 Pitch)
400	585	4	2.3	200	Cable length [m]	5 [Standard], 10

Note: Please consult HIWIN MIKROSYSTEM when using the special specification with the stroke or speed.

## 2.5 Model Number of KS05 Type

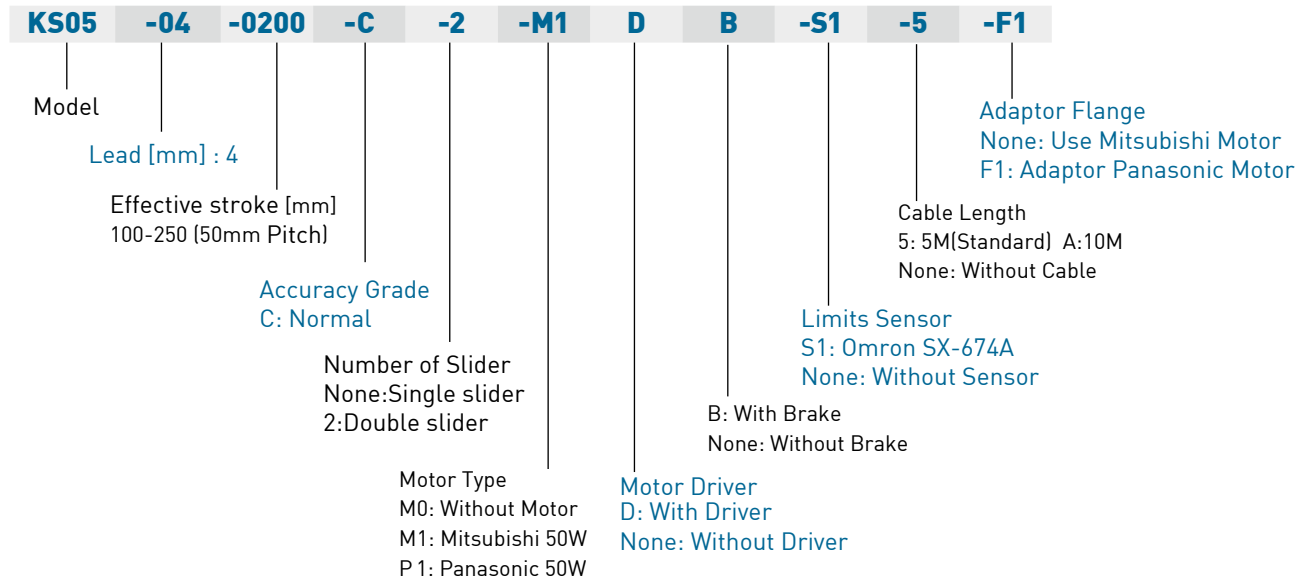

## 2.6 Dimensions for KS05 (Double slider)

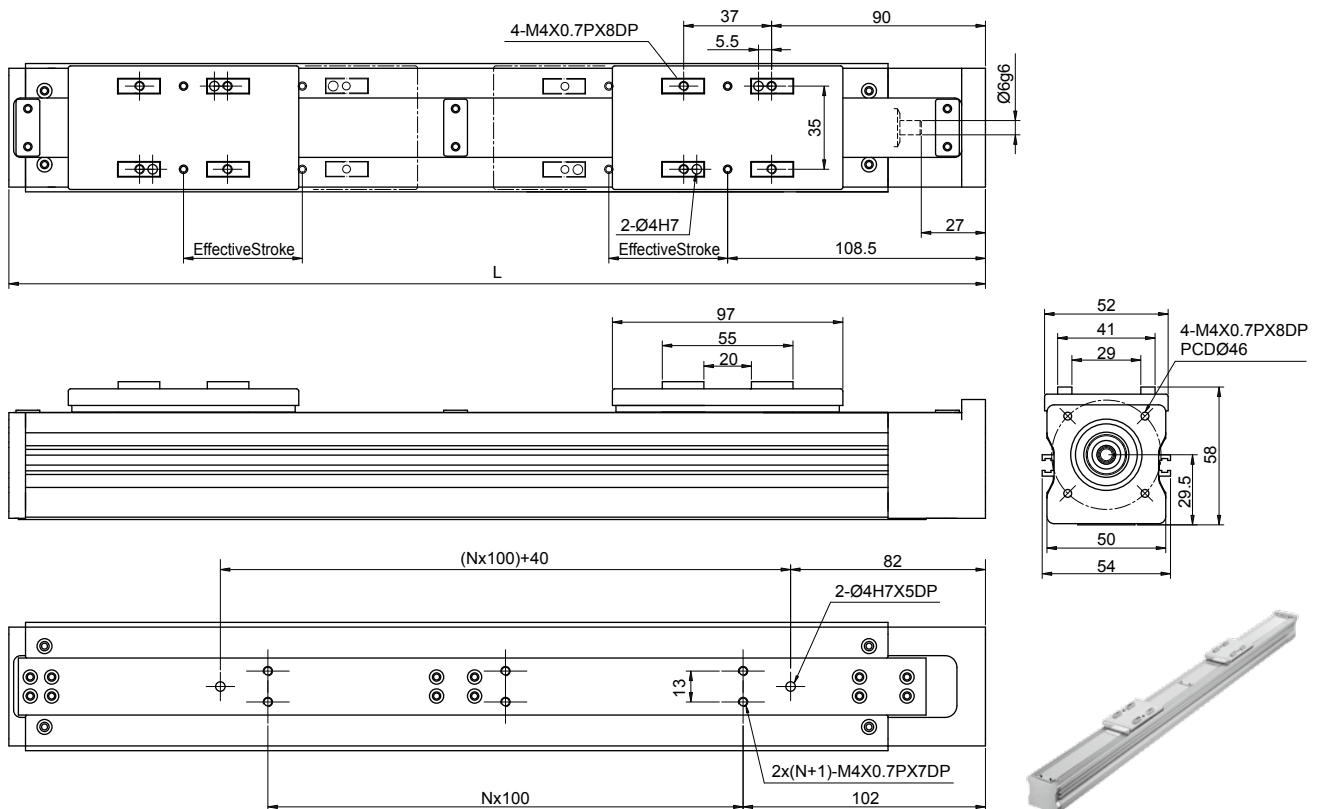

Effective Stroke (mm)	Total Length (mm)	N	Weight (kg)	Max. Speed (mm/sec)	AC Servo Motor Output (W)	50
100	511	3	2.3	200	Repeatability (mm)	Grade C: ±0.02
150	611	4	2.5	200	Ball screw lead (mm)	4
200	711	5	2.8	200	Stroke (mm)	100~250 (100 Pitch)
250	811	6	3	200	Cable length (m)	5 (Standard), 10

Note: Please consult HIWIN MIKROSYSTEM when using the special specification with the stroke or speed.





# Single Axis Robot KS Type

## 3.1 Features

- Reasonable price
- Clean room class 10-100
- Stainless covers
- Already installed AC servo motor (optional)
- High repeatability  $\pm 0.01\text{mm}$
- Dust proof
- Support different Strokes

## 3.2 Applications

- FPD industry
- Semiconductor
- Medical applications
- FPD glass transfer
- Inspection & Testing equipment



### 3.3 Model Number of KS10 Type

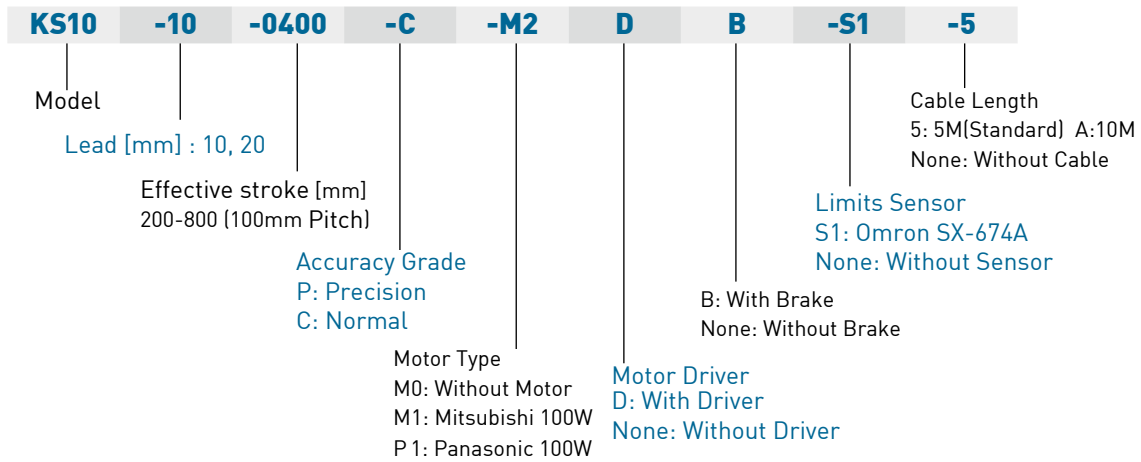

### 3.4 Dimensions for KS10

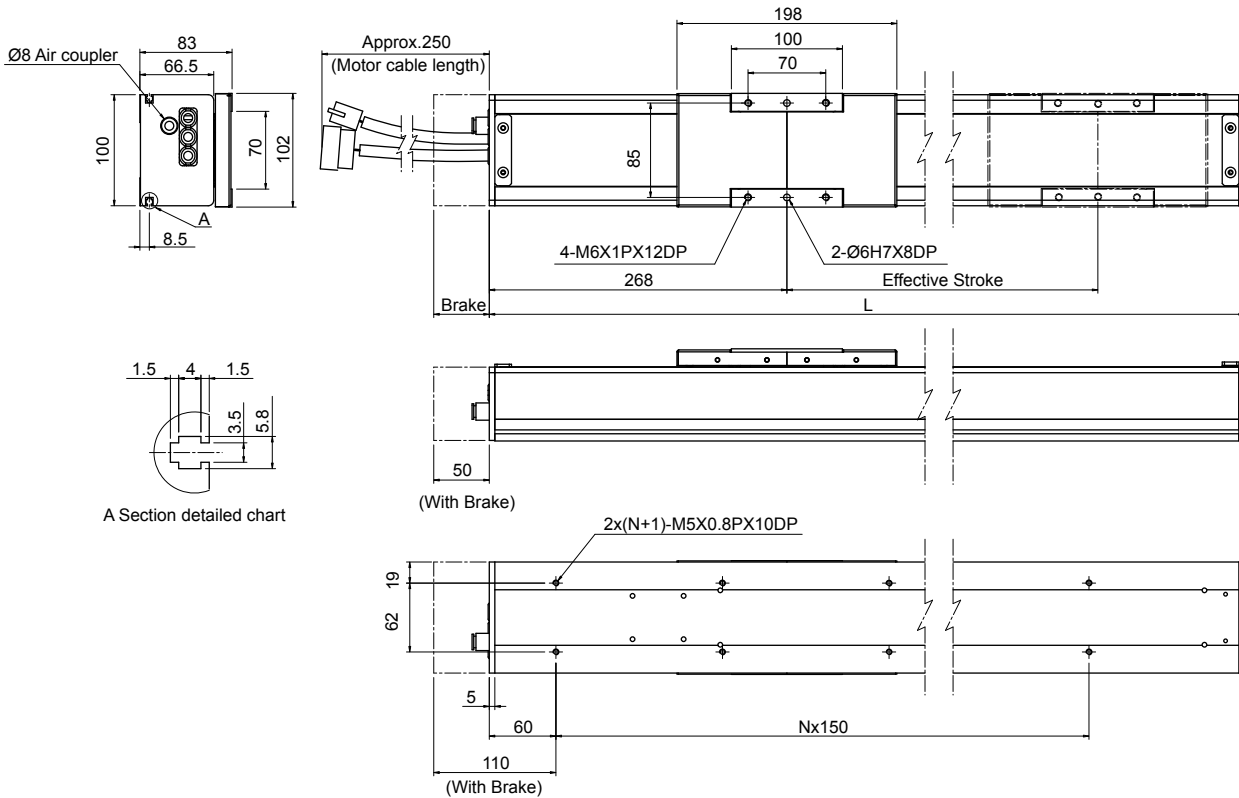

Effective Stroke (mm)	Total Length (mm)	N	Weight (kg)	Max. Speed (mm/sec)		AC Servo Motor Output(W)	100
				Lead 10	Lead 20		
200	600	3	9.1	500	1000	Repeatability (mm)	Grade C: ±0.01 Grade P: ±0.005(uni-direction)
300	700	4	9.8	500	1000		
400	800	4	10.5	500	1000	Degree of cleanroom	Class 100 (When the suction blower is used)
500	900	5	11.2	500	1000	Ball screw lead (mm)	20 or 10
600	1000	6	11.9	500	1000	Stroke (mm)	200~800 (100 Pitch)
700	1100	6	12.6	390	780	Cable length (m)	5 (Standard), 10
800	1200	7	13.3	315	630		

Note: Please consult HIWIN MIKROSYSTEM when using the special specification with the stroke or speed.

### 3.5 Model Number of KS14 Type

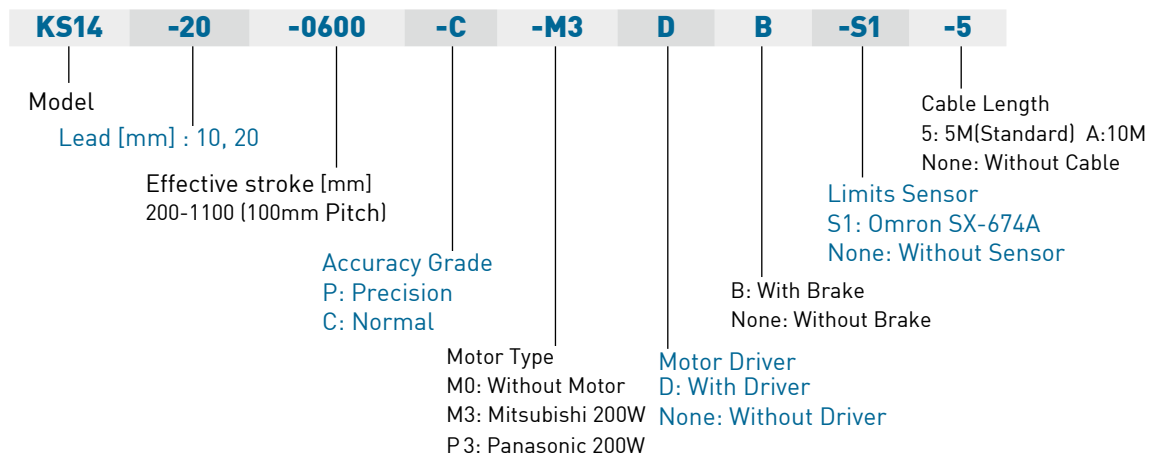

### 3.6 Dimensions for KS14

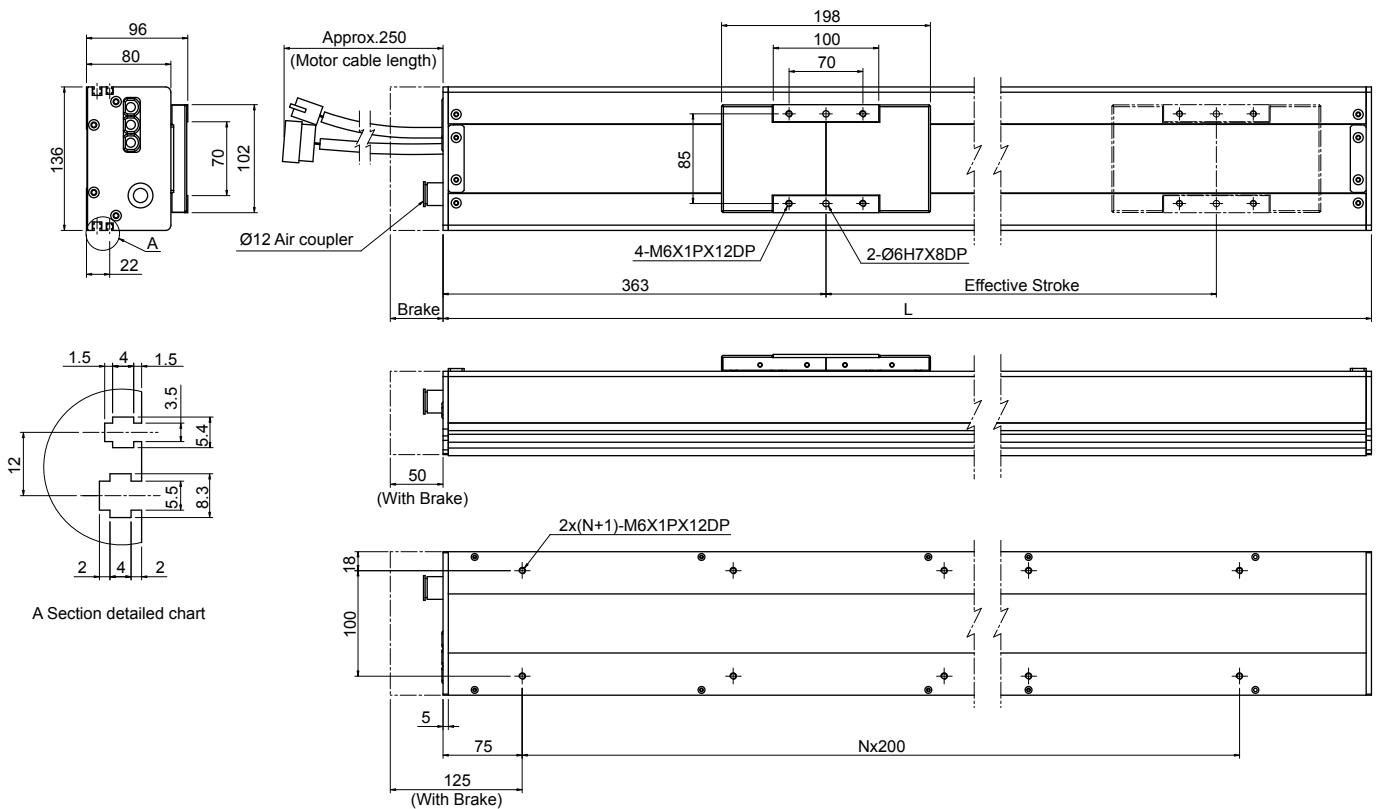

Effective Stroke (mm)	Total Length (mm)	N	Weight (kg)	Max. Speed (mm/sec)		AC Servo Motor Output(W)	100
				Lead 10	Lead 20		
200	700	3	13.5	500	1000	Repeatability (mm)	Grade C: ±0.01 Grade P: ±0.005(uni-direction)
300	800	3	14.7	500	1000		
400	900	4	15.9	500	1000	Degree of cleanroom	Class 100 (When the suction blower is used)
500	1000	4	17.1	500	1000		
600	1100	5	18.3	500	1000	Ball screw lead (mm)	20 or 10
700	1200	5	19.5	500	1000		
800	1300	6	20.7	405	810	Stroke (mm)	200~1100 (100 Pitch)
900	1400	6	21.9	340	680		
1000	1500	7	23.2	285	570	Cable length (m)	5 (Standard), 10
1100	1600	7	24.4	240	480		

Note: Please consult HIWIN MIKROSYSTEM when using the special specification with the stroke or speed.

### 3.7 Model Number of KS18 Type

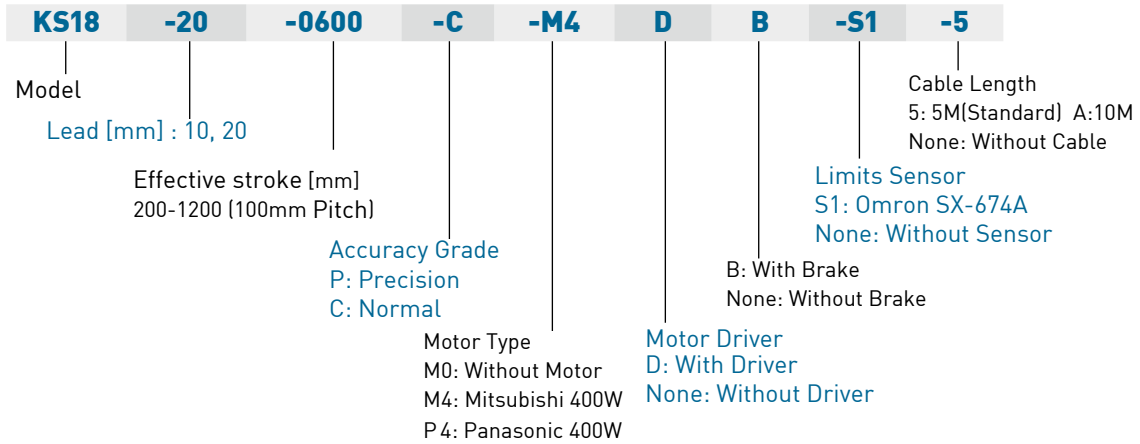

### 3.8 Dimensions for KS18

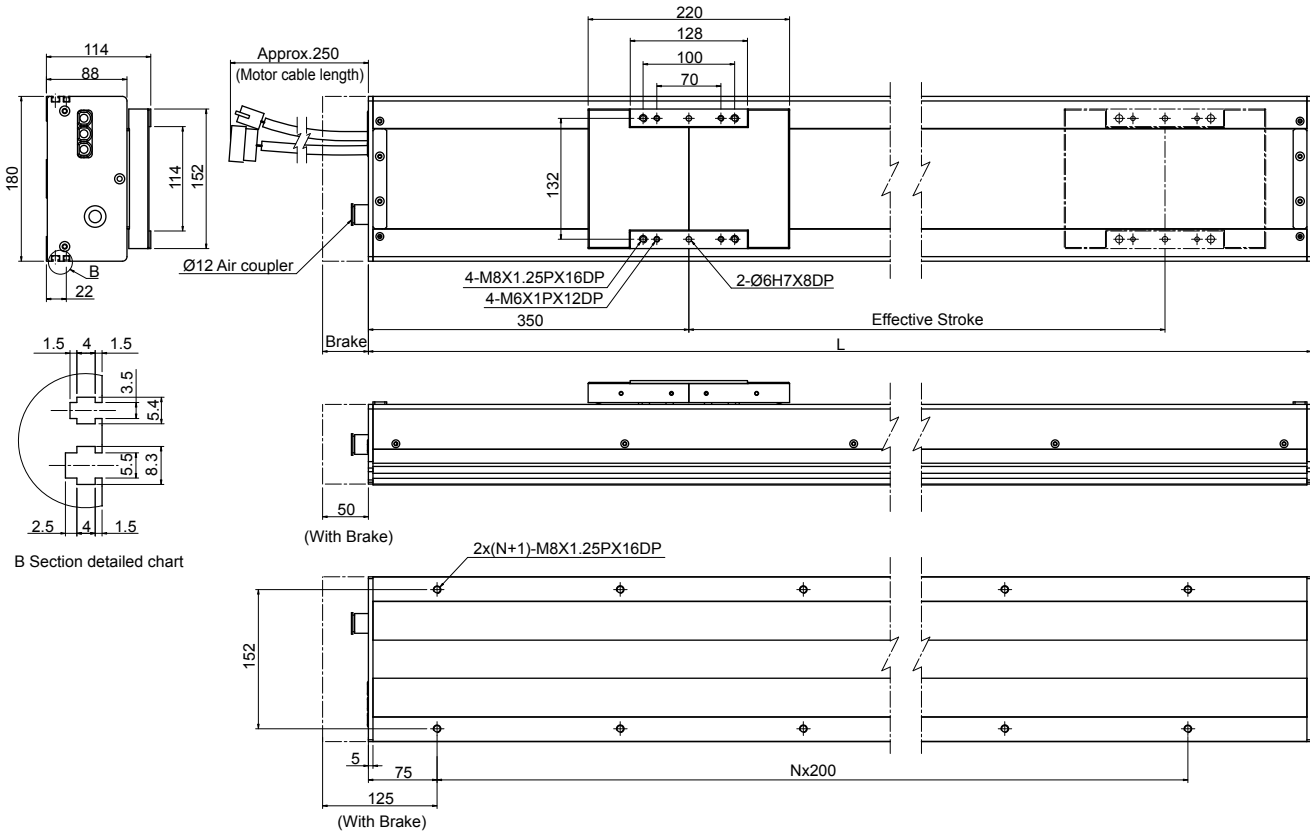

Effective Stroke (mm)	Total Length (mm)	N	Weight (kg)	Max. Speed (mm/sec)		AC Servo Motor Output(W)	400
				Lead 10	Lead 20		
200	710	3	16.5	500	1000	Repeatability (mm)	Grade C: ±0.01 Grade P: ±0.005(uni-direction)
300	810	3	18.1	500	1000		
400	910	4	19.7	500	1000	Degree of cleanroom	Class 100 (When the suction blower is used)
500	1010	4	21.3	500	1000		
600	1110	5	22.9	500	1000	Ball screw lead (mm)	20 or 10
700	1210	5	24.4	500	1000		
800	1310	6	26	405	810	Stroke (mm)	200~1200 (100 Pitch)
900	1410	6	27.6	340	680		
1000	1510	7	29.2	285	570	Cable length (m)	5 (Standard), 10
1100	1610	7	30.8	240	480		
1200	1710	8	32.3	210	420		

Note: Please consult HIWIN MIKROSYSTEM when using the special specification with the stroke or speed.

# Single Axis Robot KA Type

## 4.1 Features

- Easy for system installation and maintenance
- Low price
- High rigidity
- High repeatability  $\pm 0.01\text{mm}$
- Already installed AC servo motor (Optional)
- Support different strokes

## 4.2 Applications

- Precision industry
- FPD industry
- Automatic Dispenser
- Automatic visual inspection
- Assembly machines



### 4.3 Model Number of KA10 Type

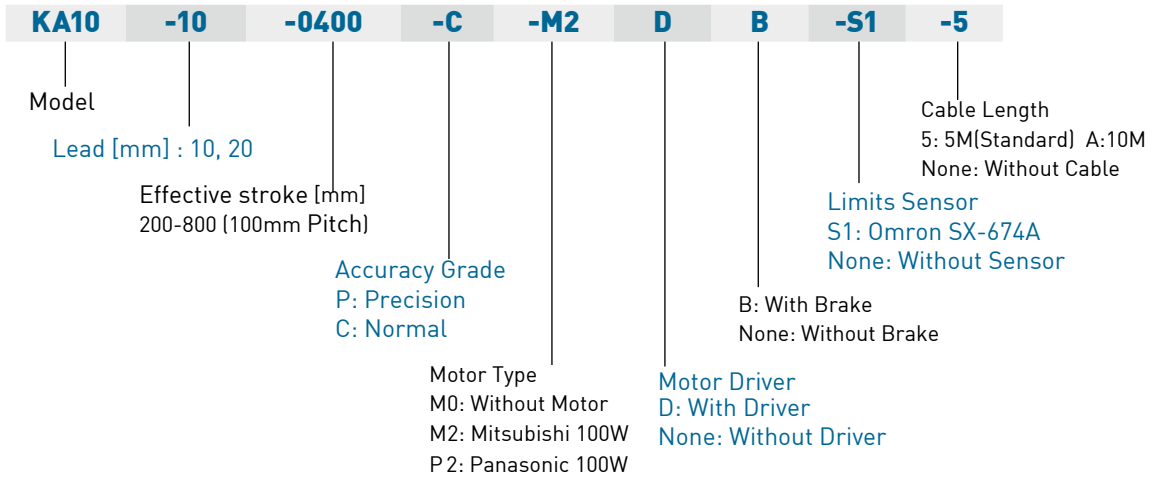

### 4.4 Dimensions for KA10

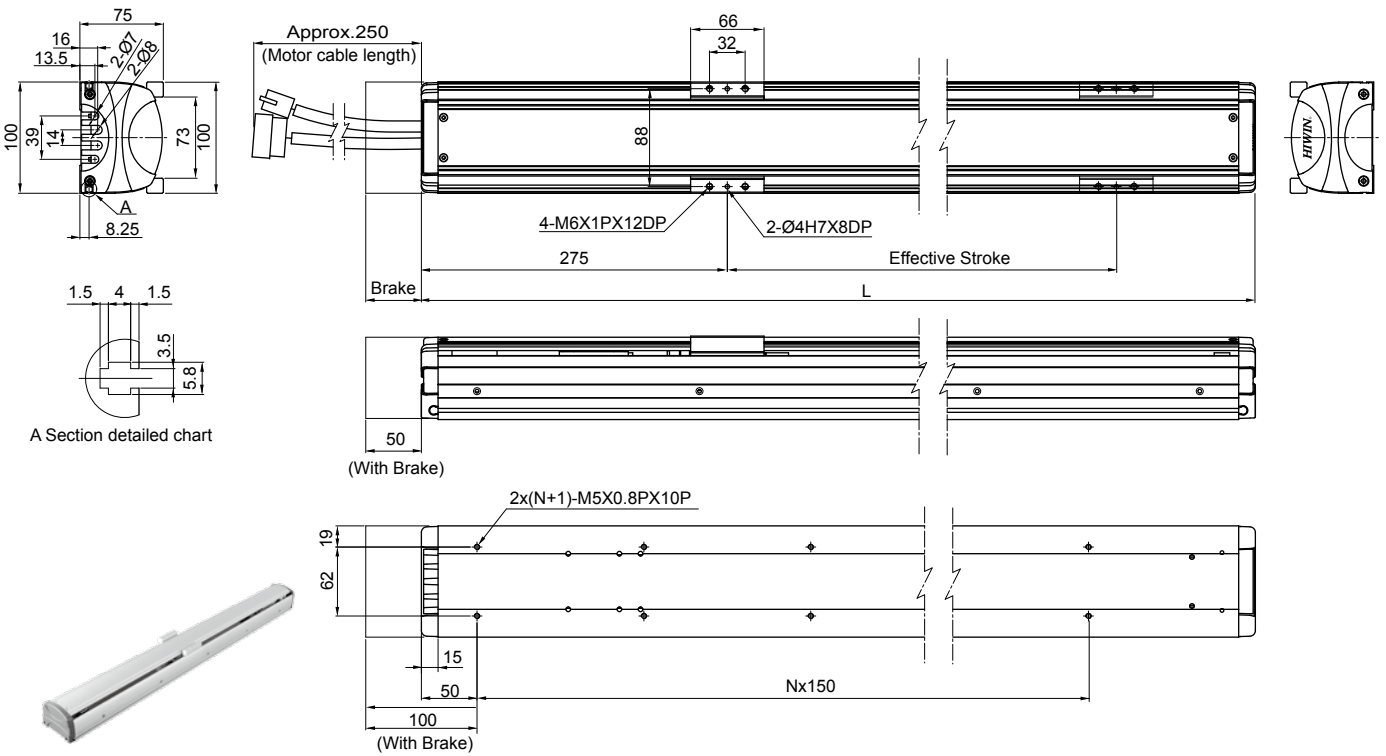

Effective Stroke (mm)	Total Length (mm)	N	Weight (kg)	Max. Speed (mm/sec)		AC Servo Motor Output(W)	100
				Lead 10	Lead 20		
200	600	3	9.1	500	1000	Repeatability (mm)	Grade C: ±0.01 Grade P: ±0.005(uni-direction)
300	700	4	9.8	500	1000		
400	800	4	10.5	500	1000	Ball screw lead (mm)	20 or 10
500	900	5	11.2	500	1000	Stroke (mm)	200~800 (100 Pitch)
600	1000	6	11.9	500	1000	Cable length (m)	5 (Standard), 10
700	1100	6	12.6	390	780		
800	1200	7	13.3	315	630		

Note: Please consult HIWIN MIKROSYSTEM when using the special specification with the stroke or speed.

## 4.5 Model Number of KA14 Type

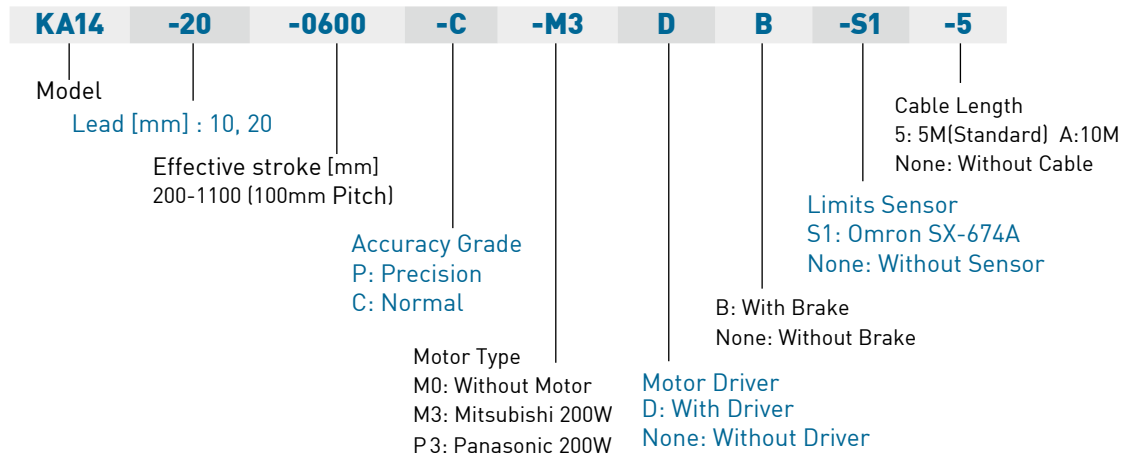

## 4.6 Dimensions for KA14

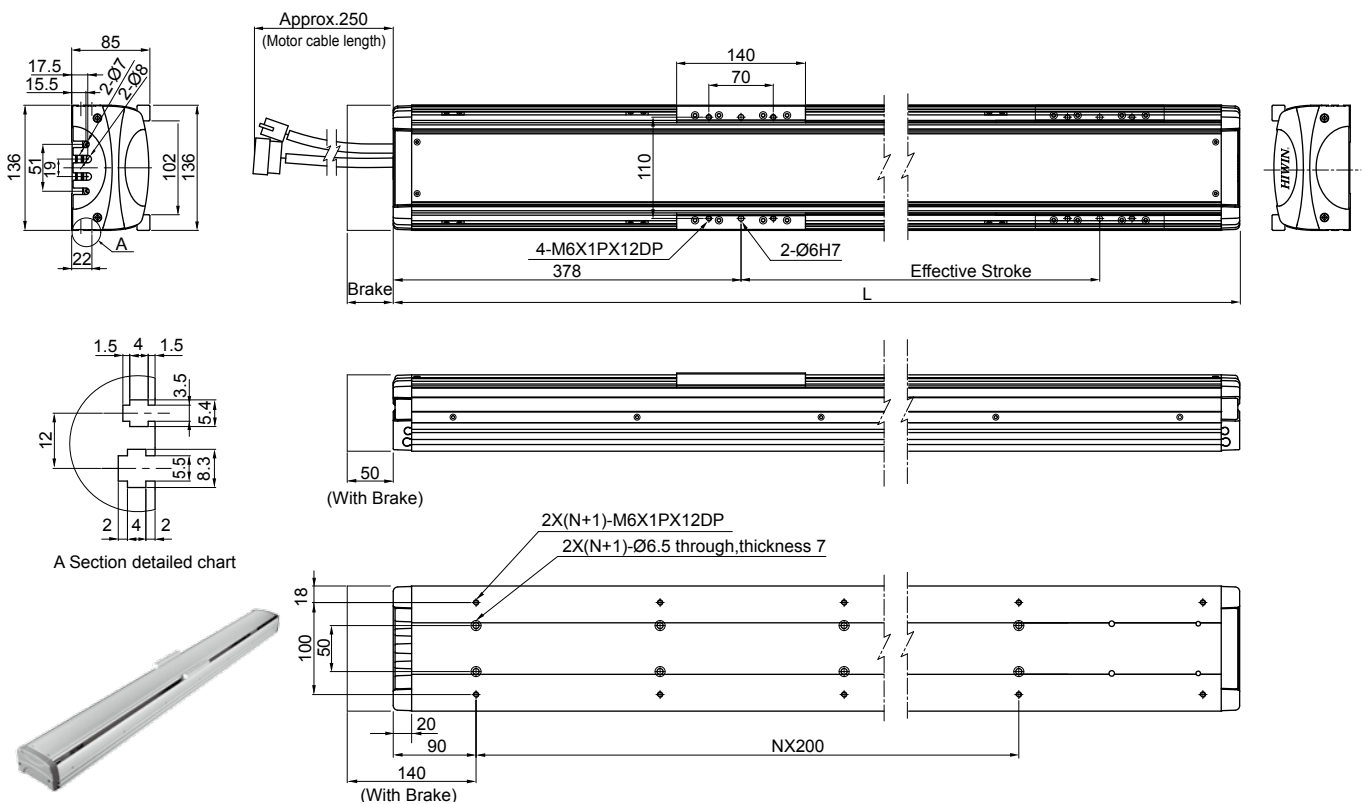

Effective Stroke (mm)	Total Length (mm)	N	Weight (kg)	Max. Speed (mm/sec)		AC Servo Motor Output(W)	100
				Lead 10	Lead 20		
200	730	3	14.1	500	1000	Repeatability (mm) Grade C: ±0.01 Grade P: ±0.005(uni-direction)	
300	830	3	15.4	500	1000		
400	930	4	16.6	500	1000		
500	1030	4	17.9	500	1000	Ball screw lead (mm)	20 or 10
600	1130	5	19.2	500	1000	Stroke (mm)	200~1100 (100 Pitch)
700	1230	5	20.5	500	1000		
800	1330	6	21.7	405	810		
900	1430	6	23	340	680	Cable length (m)	5 (Standard), 10
1000	1530	7	24.3	285	570		
1100	1630	7	25.5	240	480		

Note: Please consult HIWIN MIKROSYSTEM when using the special specification with the stroke or speed.

### 4.7 Model Number of KA18 Type

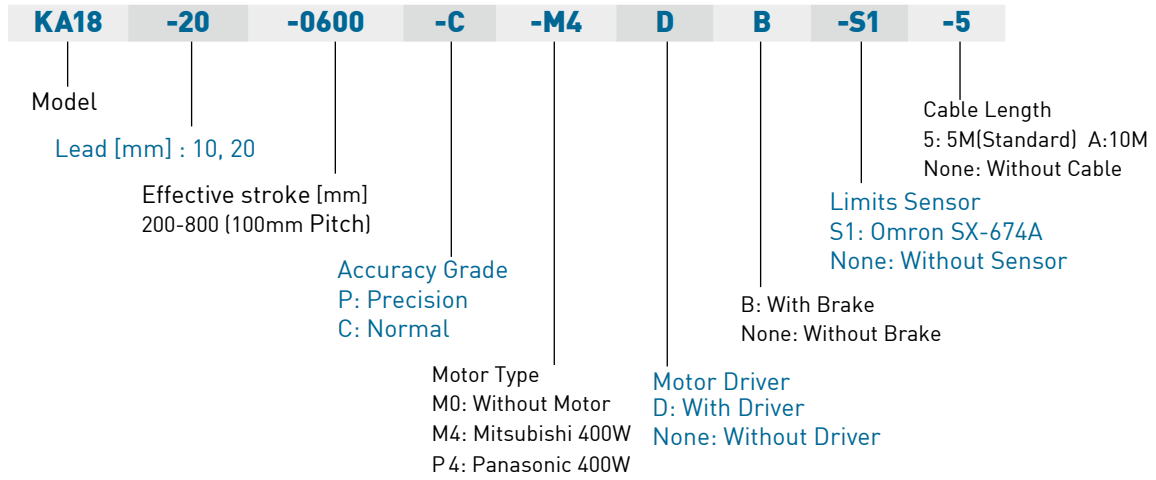

### 4.8 Dimensions for KA18

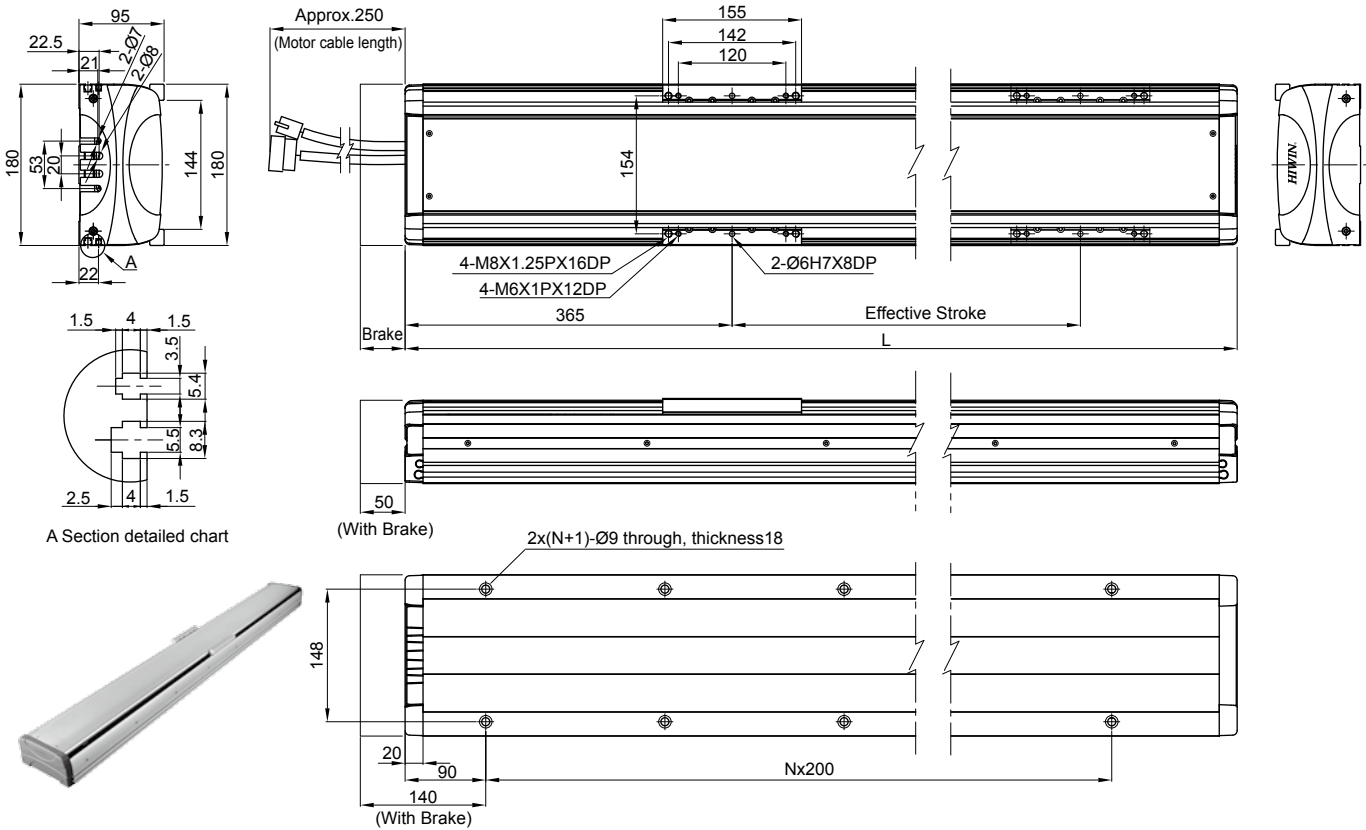

Effective Stroke (mm)	Total Length (mm)	N	Weight (kg)	Max. Speed (mm/sec)		AC Servo Motor Output(W)	400
				Lead 10	Lead 20		
200	740	3	17.5	500	1000	Repeatability (mm)	Grade C: ±0.01 Grade P: ±0.005(uni-direction)
300	840	3	19.2	500	1000		
400	940	4	20.9	500	1000	Ball screw lead (mm)	20 or 10
500	1040	4	22.5	500	1000		
600	1140	5	24.2	500	1000	Stroke (mm)	200~1200 (100 Pitch)
700	1240	5	25.9	500	1000		
800	1340	6	27.5	405	810	Cable length (m)	5 (Standard), 10
900	1440	6	29.2	340	680		
1000	1540	7	30.9	285	570		
1100	1640	7	32.5	240	480		
1200	1740	8	34.2	210	420		

Note: Please consult HIWIN MIKROSYSTEM when using the special specification with the stroke or speed.



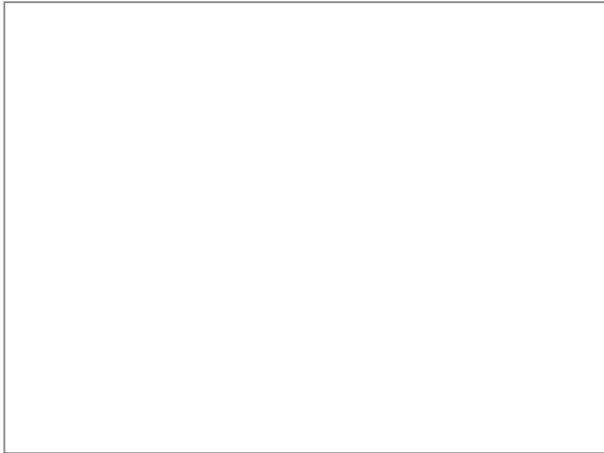

**HIWIN MIKROSYSTEM CORP.**  
No. 1, 6th Road  
Taichung Industrial Park  
Taichung 40755, TAIWAN  
Tel : +886-4-23550110  
Fax: +886-4-23550123  
www.hiwinmikro.com.tw  
business@mail.hiwinmikro.com.tw



**HIWIN TECHNOLOGIES CORP.**  
No. 46, 37th Road  
Taichung Industrial Park  
Taichung 40707, TAIWAN  
Tel: +886-4-23594510  
Fax: +886-4-23594420  
www.hiwin.com.tw  
business@mail.hiwin.com.tw

**HIWIN USA**  
•CHICAGO  
1400 Madeline Lane  
Elgin, IL. 60124, USA  
Tel: +1-847-8272270  
Fax: +1-847-8272291  
www.hiwin.com  
info@hiwin.com  
•SILICON VALLEY  
Tel: +1-510-4380871  
Fax: +1-510-4380873

**HIWIN GmbH**  
Brücklesbünd 2, D-77654  
Offenburg, GERMANY  
Tel: +49-781-93278-0  
Fax: +49-781-93278-90  
www.hiwin.de  
www.hiwin.eu  
info@hiwin.de

**HIWIN SCHWEIZ**  
Einsiedlerstrasse 535  
8810 Horgen, SWITZERLAND  
Tel: +41-44-7187000  
Fax: +41-44-7187007  
www.hiwin.ch  
info@hiwin.ch

**HIWIN CZECH**  
Kastanova 34  
CZ 62000 Brno,  
CZECH REPUBLIC  
Tel: +420-548-528238  
Fax: +420-548-220233  
www.hiwin.cz  
info@hiwin.cz

**HIWIN JAPAN**  
•KOBE  
3F. Sannomiya-Chuo Bldg.  
4-2-20 Goko-Dori. Chuo-Ku  
KOBE 651-0087, JAPAN  
Tel: +81-78-2625413  
Fax: +81-78-2625686  
www.hiwin.co.jp  
info@hiwin.co.jp