

Designation: 8224™
TNTT00

Special Features:
Track wheel configuration
on the OD.
4 point angular contact

Grease:
Chevron Dura-Lith EP2

Typical Applications:
Guide bearing for radial arm saw

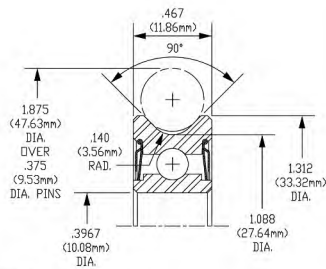

Designation: 8433™
2TNTG00

Special Features:
Low torque
PTFT™ seals

Grease:
Shell Gadus 2

Typical Applications:
Wire guide

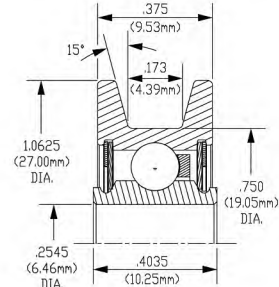

Designation: 8438™
2TNTG00

Special Features:
Low torque
Teflon™ seals

Grease:
Shell Gadus 2

Typical Applications:
Wire guide

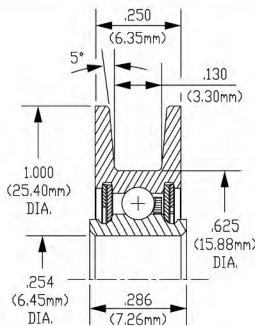

Designation: 8459™
DSTNHA00

Grease:
Exxon Polyrex EM

Typical Applications:
Track roller for automatic
sliding doors

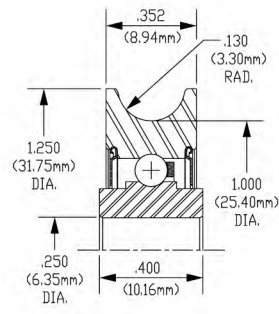

Designation: 8490™
TNTT00

Special Features:
Track wheel configuration
on the OD.
4 point angular contact

Grease:
Chevron Dura-Lith EP2

Typical Applications:
Guide bearing for radial arm saw

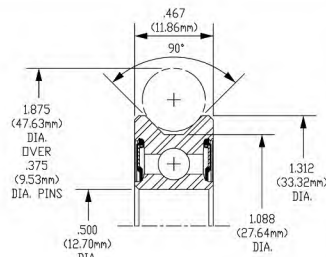

Designation: 8727™
DCJN20XX24

Special Features:
Steel retainer

Grease:
Solid polymer lubrication

Typical Applications:
TIG welder wire guide

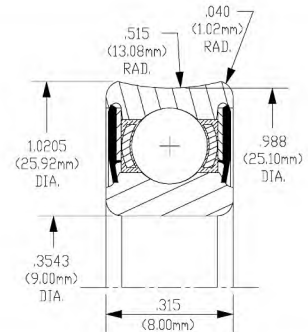

Designation: 8741™
ADSUD24

Special Features:
Harden outer

Grease:
Mobilgrease 28

Typical Applications:
Wire pulley for medical imaging machines

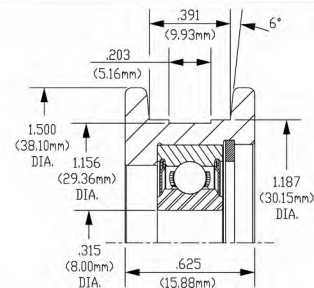

Designation: 8752™
ADCN65XX24

Special Features:
Hard chrome plating

Typical Applications:
Wire guide

