

INDEX

EASY RAIL: THE SOLUTION IS EASY.....	D4
EXAMPLES OF LOAD CAPACITIES.....	D5
ORDER CODES.....	D6
MOUNTING EXAMPLES.....	D7
TECHNICAL DATA.....	D8
STANDARD CONFIGURATIONS.....	D10
VERIFICATION UNDER STATIC LOAD.....	D12
LIFETIME CALCULATION.....	D13
CLEARANCE AND PRELOAD.....	D13
FRICTION COEFFICIENT.....	D13
LINEAR PRECISION.....	D13
SPEED.....	D13
APPLICATION NOTES.....	D14
TEMPERATURE.....	D14
ANTICORROSIVE PROTECTION.....	D14
LUBRICATION.....	D14

EASY RAIL: THE SOLUTION IS EASY

Simplicity is the distinguishing characteristic of this family of **steel linear bearings**. Designed to quickly and easily fit into demanding applications, these **simple yet durable** bearings confirm **ROLLON's** commitment to offering **innovative linear solutions** to real world applications.

Easy: these **versatile** rails solve extremely diverse and apparently complex problems of linear motion with ease. They are at home wherever **compactness, smooth movement, high load capacity**, and versatility are needed along with **affordability**; where **reliability is key** and where **ease of mounting** takes slight precedence over absolute **precision**. **EASY RAIL** solves problems. **EASY RAIL** contains five different sized sections – 22, 28, 35, 43, 63 mm – offering linear precision of up to 100 microns and load capacities of several thousand pounds per slider. With many different slider lengths available per section, several hundred different combinations of solutions are possible.

The three main components, the hardened rail, the hardened slider, and the ballcage, assembled in many different ways, are able to quickly resolve most needs whether based on load capacity or on stroke.

Assembled with particular care and attention, these **high-quality** slides can be **mounted quickly and easily** allowing notable saving in mounting time.

While the simplicity of these slides may be their most distinguishing characteristic, their numerous other advantages need mentioning:

Compactness. The slider always runs *inside* the **hardened steel races** of the rail – typical of Rollon's innovative products.

High Strength. The raceways of both slider and rail are always hardened. Combined with the hardened ball-bearings, these slides will carry **extremely high loads** with continual movements.

Reliability. The **quality** of both materials and workmanship allow these linear bearings to offer repeated, continual, inexpensive, and smooth movement even in severe conditions.

EASY RAIL products have been applied in the most varied of sectors. A few application examples: protective door enclosures, providing the movement in medical machinery such as X-ray tables, single or multiple axis manipulators. Wherever a heavy duty, compact, reliable, and affordable linear bearing is needed, the solution is EASY.

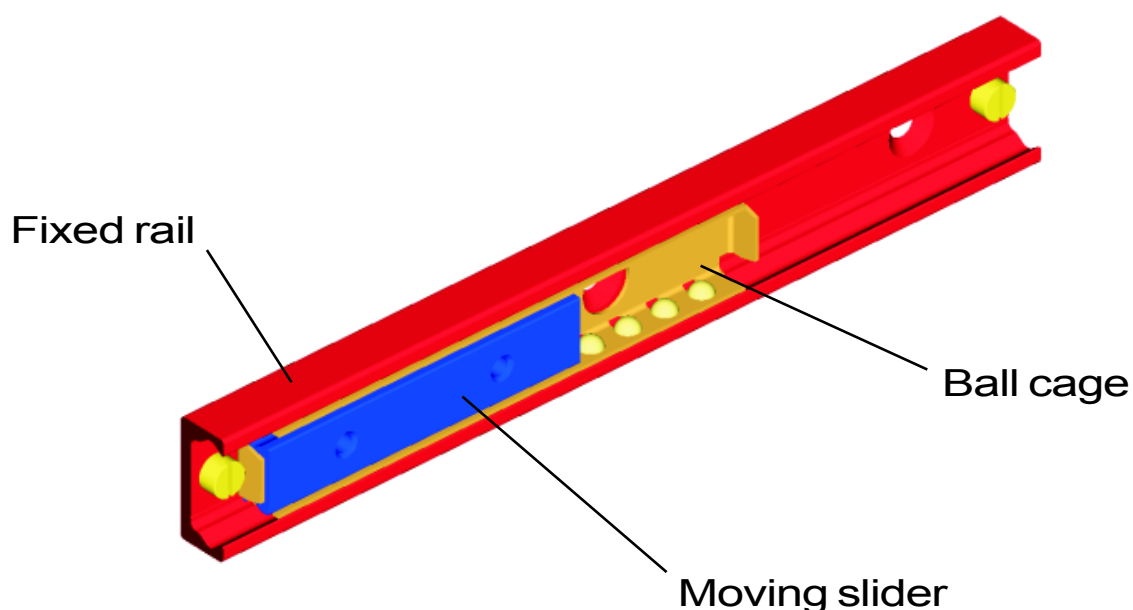

EXAMPLES OF LOAD CAPACITIES

• “SN22” SERIES

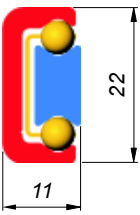

Slider length [mm]	Load capacity					Slider length [mm]	Load capacity				
	C _{0rad} [N]	C _{0ax} [N]	M _x [Nm]	M _y [Nm]	M _z [Nm]		C _{0rad} [N]	C _{0ax} [N]	M _x [Nm]	M _y [Nm]	M _z [Nm]
40	1320	924	8	6	9	130	4290	3003	26	65	93
60	1980	1386	12	14	20	210	6930	4851	42	170	243
80	2640	1848	16	25	35	290	9570	6699	58	324	463

Rail length [mm]	
130, 210, 290, 370, 450, 530, 610, 690, 770, 850, 930, 1010, 1170	

• “SN28” SERIES

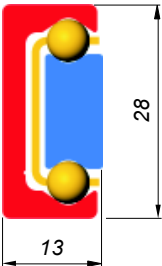

Slider length [mm]	Load capacity					Slider length [mm]	Load capacity				
	C _{0rad} [N]	C _{0ax} [N]	M _x [Nm]	M _y [Nm]	M _z [Nm]		C _{0rad} [N]	C _{0ax} [N]	M _x [Nm]	M _y [Nm]	M _z [Nm]
60	3480	2436	28	24	35	290	16820	11774	136	569	813
80	4640	3248	38	43	62	370	21460	15022	174	926	1323
130	7540	5278	61	114	163	450	26100	18270	211	1370	1958
210	12180	8526	98	298	426						

Rail length [mm]	
130, 210, 290, 370, 450, 530, 610, 690, 770, 850, 930, 1010, 1170, 1330, 1490, 1650	

• “SN35” SERIES

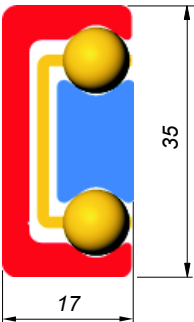

Slider length [mm]	Load capacity					Slider length [mm]	Load capacity				
	C _{0rad} [N]	C _{0ax} [N]	M _x [Nm]	M _y [Nm]	M _z [Nm]		C _{0rad} [N]	C _{0ax} [N]	M _x [Nm]	M _y [Nm]	M _z [Nm]
130	9750	6825	95	148	211	450	33750	23625	327	1772	2531
210	15750	11025	153	386	551	530	39750	27825	385	2458	3511
290	21750	15225	211	736	1051	610	45750	32025	444	3256	4651
370	27750	19425	269	1198	1711						

Rail length [mm]	
290, 370, 450, 530, 610, 690, 770, 850, 930, 1010, 1170, 1330, 1490, 1650, 1810	

• “SN43” SERIES

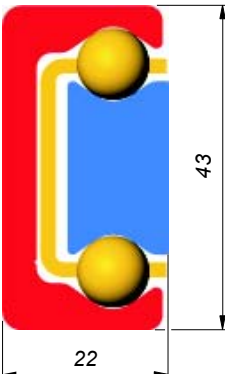

Slider length [mm]	Load capacity					Slider length [mm]	Load capacity				
	C _{0rad} [N]	C _{0ax} [N]	M _x [Nm]	M _y [Nm]	M _z [Nm]		C _{0rad} [N]	C _{0ax} [N]	M _x [Nm]	M _y [Nm]	M _z [Nm]
130	13910	9737	172	211	301	450	48150	33705	595	2528	3611
210	22470	15729	278	551	786	530	56710	39697	701	3507	5009
290	31030	21721	383	1050	1500	610	65270	45689	806	4645	6636
370	39590	27713	489	1709	2441						

Rail length [mm]	
290, 370, 450, 530, 610, 690, 770, 850, 930, 1010, 1170, 1330, 1490, 1650, 1810, 1970	

• “SN63” SERIES

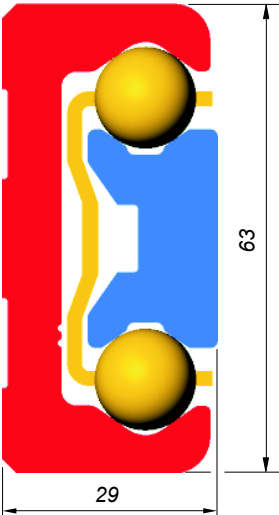

Slider length [mm]	Load capacity					Slider length [mm]	Load capacity				
	C _{0rad} [N]	C _{0ax} [N]	M _x [Nm]	M _y [Nm]	M _z [Nm]		C _{0rad} [N]	C _{0ax} [N]	M _x [Nm]	M _y [Nm]	M _z [Nm]
130	26000	18200	443	394	563	450	90000	63000	1534	4725	6750
210	42000	29400	716	1029	1470	530	106000	74200	1807	6554	9363
290	58000	40600	989	1962	2803	610	122000	85400	2079	8682	12403
370	74000	51800	1261	3194	4563						

Rail length [mm]	
610, 690, 770, 850, 930, 1010, 1170, 1330, 1490, 1650, 1810, 1970	

For order codes see page D6.
For other technical data see pages D8, D9, D10, D11

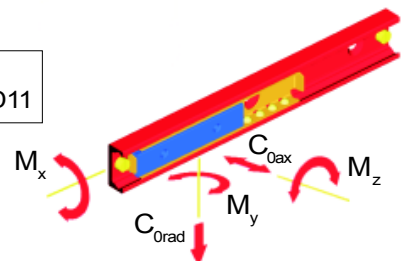

ORDER CODES

The **SN** series linear bearings are composed of three main elements. By combining the elements to fit your application requirements, you can order a standard product that fits the application as though it were custom made for it. The components are:

- A **cold-drawn**, C-shaped **steel rail** with **induction-hardened raceways**. The external dimensions of this compact rail are the same as the complete bearing since the other two elements move inside the **well-protected**, *internal* raceways. This rigid rail is often mounted to the fixed structure, with countersunk screws.
- One or more **cold-drawn steel sliders** with **induction hardened raceways**. The slider moves *inside* the C-shaped rail and is generally attached to the moving structure where it transfers the load to the rail through a double row of ball bearings. Threaded holes permit the sliders to be mounted to the moving structure.
- One or more steel **cages**, each with a **double row of high precision ball-bearings** made from bearing steel. The ballcage allows the slider to easily move inside the rail with almost no friction. There are three principle ways of combining these components to form standard yet seemingly custom fit linear bearings (for more detailed information and assistance, please contact our engineering department).

- SN SERIES WITH A SINGLE SLIDER:

This is the simplest and most popular combination (we refer to this combination on pages D8, D9, D10 and D11) with **one internal slider and ballcage running inside the rail**.

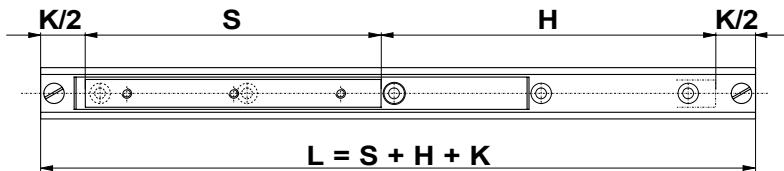

Order code:

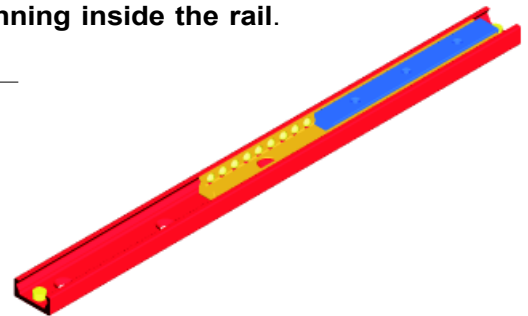
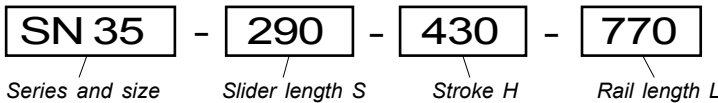

- SN SERIES WITH MULTIPLE "INDEPENDENT" SLIDERS:

Inside one rail are multiple sliders, each running inside its own ballcage. The multiple sliders have the same length and stroke but can move independently.

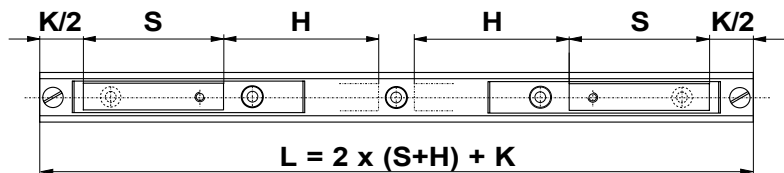

Order code:

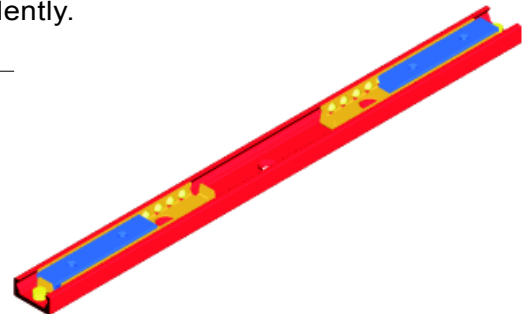
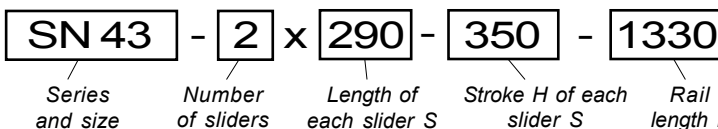

- SN SERIES WITH MULTIPLE "SYNCHRONIZED" SLIDERS:

Inside one rail are multiple sliders, each running inside the same ballcage. The multiple sliders can be of different lengths and can be spaced apart.

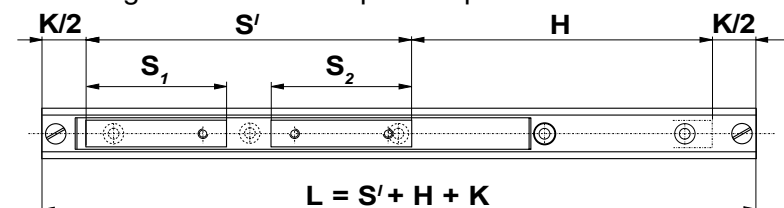

Order code:

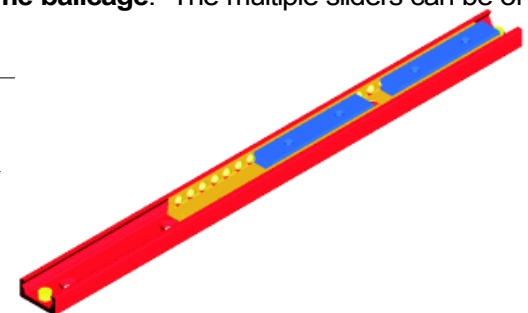
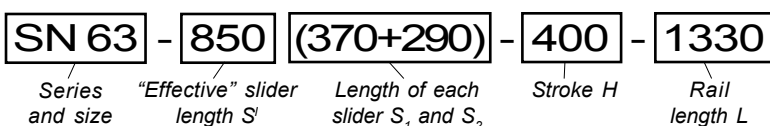

For all technical data, see pages D8, D9, D10 and D11

MOUNTING EXAMPLES

With regard to the external load, the rail may be used in both the positions shown in the diagrams at right. However, when it is used in the position shown in the diagram 2 (axially) the load capacity will be reduced to 70% of the radial capacity C_{0rad} (see also **Verification under static load** on page D12).

The number of fixing holes in standard length rails is sufficient to support the stated loads, provided that the track-rails are fixed with screws having a minimum quality of class 10.9. **The fixed rail and slider assume the stiffness as the structure to which they are mounted.** Therefore they must both be mounted to rigid structures with suitably strong screws.

An angled, adjustable support as shown at right is not necessary but will reduce the shear stress on the screws and will increase the stiffness of the system. Flush-mounted or non-adjustable supports, like those shown in the two diagrams at right, cannot guarantee support of the rail because countersunk screws must be used for fixing.

Stroke end stops must be fitted on the moving element of the machine. The built-in stops on the ball bearings are only in place to prevent dismantling and **are not suitable** for use as stroke end stops on the machine. We also suggest that there are slotted fixing holes on the machine part connecting to the slider.

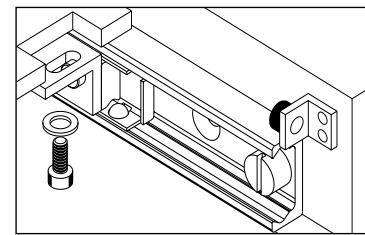
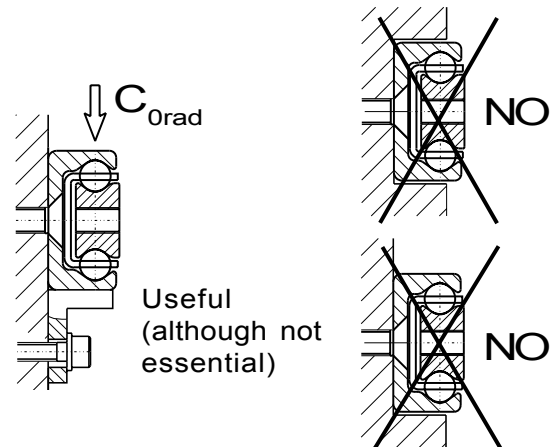
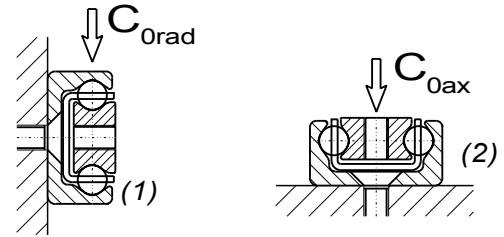

- APPLICATION "IDEAS": MEANS OF TRANSPORT DOORS

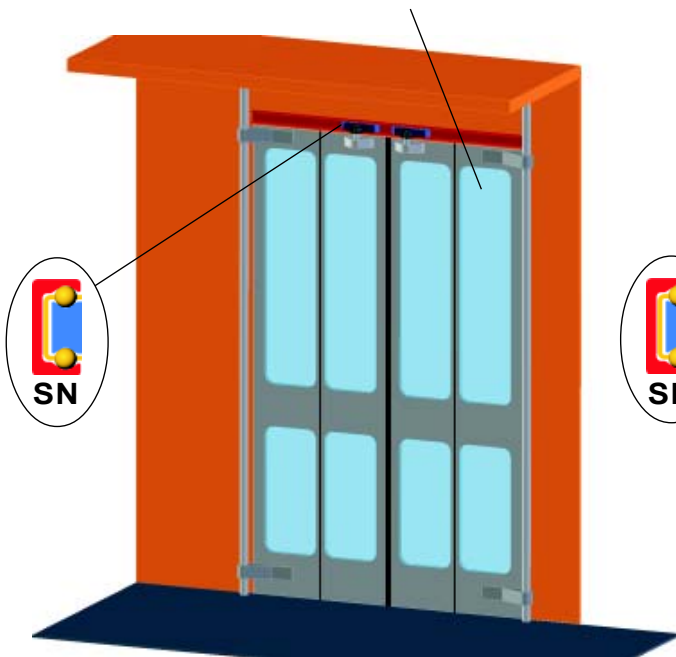

MACHINE TOOLS (PROTECTIVE ENCLOSURES)

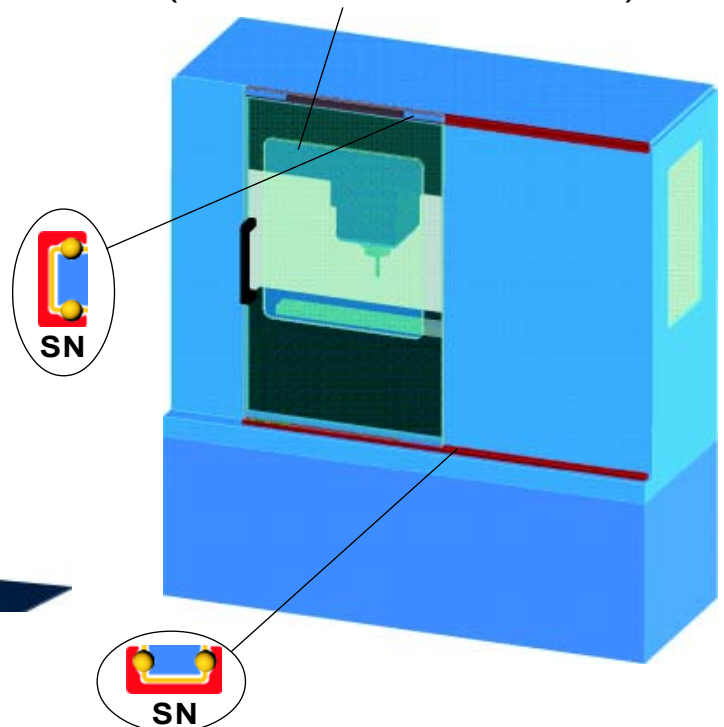

Other important application fields are packaging machines, medical equipment etc.

TECHNICAL DATA

By combining the three main standard components with the rules listed below, it is possible to obtain standard linear bearings that are custom fit to each application (for **order codes** see page D6, for **standard configurations**, see pages D10 and D11).

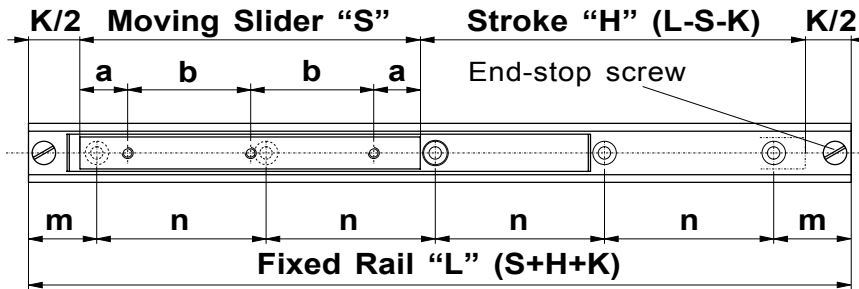

KEY RULES:

1. To ensure access to all mounting holes in the rail, it is necessary that $S \leq L/2 - K$. This means that the slider length must be less than or equal to half of the rail length minus a constant "K" (different for each size).
 2. To help choose the right rail length it is necessary to remember that $L = S + H + K$. In other words, the length of the slider plus the stroke plus the constant "K" must always equal the total rail length.
 3. To ensure proper smooth movement, it is necessary that $H \leq 7S$. This means that the maximum theoretical stroke can never exceed seven times the slider length S (this maximum theoretical stroke is not always reachable with the standard rail lengths listed below. The maximum *real* stroke possible is limited by Rule 2).
- Example:* choosing the 130 mm slider for an **SN28**, the maximum theoretical stroke is 910 mm (Rule 3). In actuality, a standard SN28-130-... can only have a *real* max. stroke H of 840 mm (Rule 2: $1030+840+40=1010$ mm). If the next longer rail (1170 mm) had been chosen, the obtainable stroke would be 1000 mm, longer than the allowable value (violating Rule 3). The correct code is therefore **SN28-130-840-1010**. (See page D6 for more)

• **"SN22" SERIES**

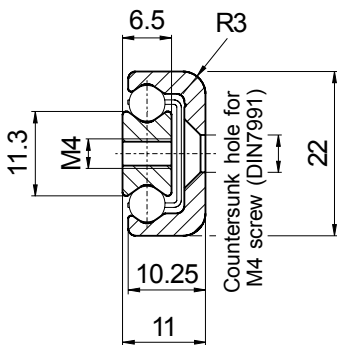

Ordering Example:
 - Moving slider **S**: 210 mm;
 - Required stroke **H**: 610 mm;
 - Fixed rail **L**: $210 + 610 + 30 = 850$ mm
 (see Rule 2 above). The correct order code is therefore: **SN22-210-610-850**.

Moving Slider				Load capacity				
S [mm]	a [mm]	b [mm]	N. holes	C _{0rad} [N]	C _{0ax} [N]	M _x [Nm]	M _y [Nm]	M _z [Nm]
40	10	20	2	1320	924	8	6	9
60	10	20	3	1980	1386	12	14	20
80	10	20	4	2640	1848	16	25	35
130	25	80	2	4290	3003	26	65	93
210	25	80	3	6930	4851	42	170	243
290	25	80	4	9570	6699	58	324	463

Fixed Rail					Fixed Rail				
L [mm]	m [mm]	n [mm]	N. holes	K [mm]	L [mm]	m [mm]	n [mm]	N. holes	K [mm]
130	25	80	2	30	690	25	80	9	30
210	25	80	3	30	770	25	80	10	30
290	25	80	4	30	850	25	80	11	30
370	25	80	5	30	930	25	80	12	30
450	25	80	6	30	1010	25	80	13	30
530	25	80	7	30	1170	25	80	15	30
610	25	80	8	30					

Moving Slider weight: 1.0 g/mm
 Fixed Rail weight: 0.7 g/mm

• **"SN28" SERIES**

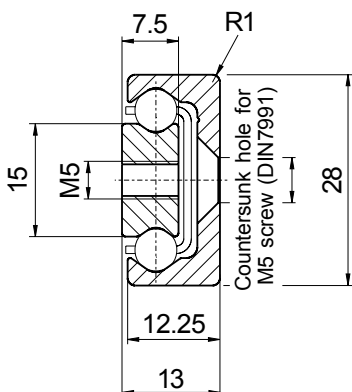

Moving Slider				Load Capacity				
S [mm]	a [mm]	b [mm]	N. holes	C _{0rad} [N]	C _{0ax} [N]	M _x [Nm]	M _y [Nm]	M _z [Nm]
60	10	20	3	3480	2436	28	24	35
80	10	20	4	4640	3248	38	43	62
130	25	80	2	7540	5278	61	114	163
210	25	80	3	12180	8526	98	298	426
290	25	80	4	16820	11774	136	569	813
370	25	80	5	21460	15022	174	926	1323
450	25	80	6	26100	18270	211	1370	1958

Fixed Rail					Fixed Rail				
L [mm]	m [mm]	n [mm]	N. holes	K [mm]	L [mm]	m [mm]	n [mm]	N. holes	K [mm]
130	25	80	2	40	770	25	80	10	40
210	25	80	3	40	850	25	80	11	40
290	25	80	4	40	930	25	80	12	40
370	25	80	5	40	1010	25	80	13	40
450	25	80	6	40	1170	25	80	15	40
530	25	80	7	40	1330	25	80	17	40
610	25	80	8	40	1490	25	80	19	40
690	25	80	9	40	1650	25	80	21	40

Moving Slider weight: 1.5 g/mm
 Fixed Rail weight: 1.0 g/mm

• “SN35” SERIES

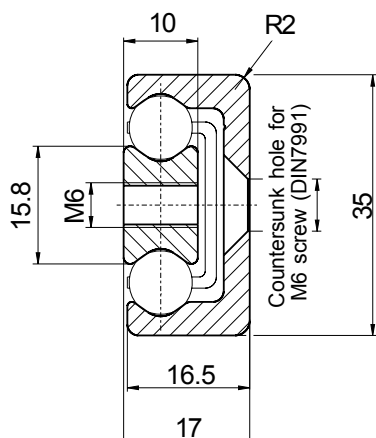

Moving Slider				Load Capacity				
S [mm]	a [mm]	b [mm]	N. holes	C _{0rad} [N]	C _{0ax} [N]	M _x [Nm]	M _y [Nm]	M _z [Nm]
130	25	80	2	9750	6825	95	148	211
210	25	80	3	15750	11025	153	386	551
290	25	80	4	21750	15225	211	736	1051
370	25	80	5	27750	19425	269	1198	1711
450	25	80	6	33750	23625	327	1772	2531
530	25	80	7	39750	27825	385	2458	3511
610	25	80	8	45750	32025	444	3256	4651

Moving Slider weight:
2.5 g/mm

Fixed Rail					Fixed Rail				
L [mm]	m [mm]	n [mm]	N. holes	K [mm]	L [mm]	m [mm]	n [mm]	N. holes	K [mm]
290	25	80	4	50	930	25	80	12	50
370	25	80	5	50	1010	25	80	13	50
450	25	80	6	50	1170	25	80	15	50
530	25	80	7	50	1330	25	80	17	50
610	25	80	8	50	1490	25	80	19	50
690	25	80	9	50	1650	25	80	21	50
770	25	80	10	50	1810	25	80	23	50
850	25	80	11	50					

Fixed Rail weight:
1.8 g/mm

• “SN43” SERIES

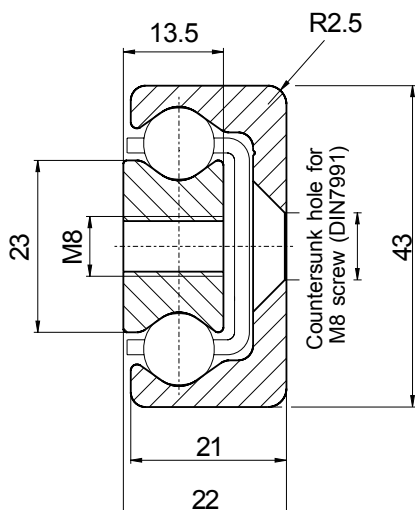

Moving Slider				Load Capacity				
S [mm]	a [mm]	b [mm]	N. holes	C _{0rad} [N]	C _{0ax} [N]	M _x [Nm]	M _y [Nm]	M _z [Nm]
130	25	80	2	13910	9737	172	211	301
210	25	80	3	22470	15729	278	551	786
290	25	80	4	31030	21721	383	1050	1500
370	25	80	5	39590	27713	489	1709	2441
450	25	80	6	48150	33705	595	2528	3611
530	25	80	7	56710	39697	701	3507	5009
610	25	80	8	65270	45689	806	4645	6636

Moving Slider weight:
5.0 g/mm

Fixed Rail					Fixed Rail				
L [mm]	m [mm]	n [mm]	N. holes	K [mm]	L [mm]	m [mm]	n [mm]	N. holes	K [mm]
290	25	80	4	50	930	25	80	12	50
370	25	80	5	50	1010	25	80	13	50
450	25	80	6	50	1170	25	80	15	50
530	25	80	7	50	1330	25	80	17	50
610	25	80	8	50	1490	25	80	19	50
690	25	80	9	50	1650	25	80	21	50
770	25	80	10	50	1810	25	80	23	50
850	25	80	11	50	1970	25	80	25	50

Fixed Rail weight:
2.6 g/mm

• “SN63” SERIES

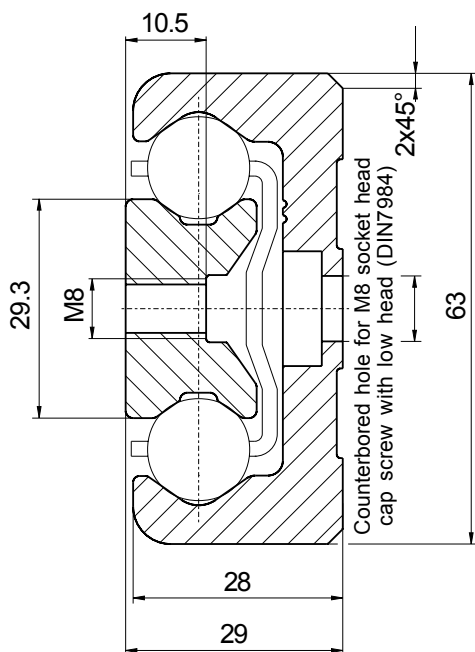

Moving Slider				Load Capacity				
S [mm]	a [mm]	b [mm]	N. holes	C _{0rad} [N]	C _{0ax} [N]	M _x [Nm]	M _y [Nm]	M _z [Nm]
130	25	80	2	26000	18200	443	394	563
210	25	80	3	42000	29400	716	1029	1470
290	25	80	4	58000	40600	989	1962	2803
370	25	80	5	74000	51800	1261	3194	4563
450	25	80	6	90000	63000	1534	4725	6750
530	25	80	7	106000	74200	1807	6554	9363
610	25	80	8	122000	85400	2079	8682	12403

Moving Slider weight:
6.9 g/mm

Fixed Rail					Fixed Rail				
L [mm]	m [mm]	n [mm]	N. holes	K [mm]	L [mm]	m [mm]	n [mm]	N. holes	K [mm]
610	25	80	8	80	1170	25	80	15	80
690	25	80	9	80	1330	25	80	17	80
770	25	80	10	80	1490	25	80	19	80
850	25	80	11	80	1650	25	80	21	80
930	25	80	12	80	1810	25	80	23	80
1010	25	80	13	80	1970	25	80	25	80

Fixed Rail weight:
6.1 g/mm

STANDARD CONFIGURATIONS

SN22 SERIES

Order Code	Slider	Stroke	Rail
SN22-40-60-130	40	60	130
SN22-40-140-210	40	140	210
SN22-40-220-290	40	220	290
SN22-60-40-130	60	40	130
SN22-60-120-210	60	120	210
SN22-60-200-290	60	200	290
SN22-60-280-370	60	280	370
SN22-60-360-450	60	360	450
SN22-80-100-210	80	100	210
SN22-80-180-290	80	180	290
SN22-80-260-370	80	260	370
SN22-80-340-450	80	340	450
SN22-80-420-530	80	420	530
SN22-80-500-610	80	500	610
SN22-130-130-290	130	130	290
SN22-130-210-370	130	210	370
SN22-130-290-450	130	290	450
SN22-130-370-530	130	370	530
SN22-130-450-610	130	450	610
SN22-130-530-690	130	530	690

Order Code	Slider	Stroke	Rail
SN22-130-610-770	130	610	770
SN22-130-690-850	130	690	850
SN22-130-770-930	130	770	930
SN22-130-850-1010	130	850	1010
SN22-210-210-450	210	210	450
SN22-210-290-530	210	290	530
SN22-210-370-610	210	370	610
SN22-210-450-690	210	450	690
SN22-210-530-770	210	530	770
SN22-210-610-850	210	610	850
SN22-210-690-930	210	690	930
SN22-210-770-1010	210	770	1010
SN22-210-930-1170	210	930	1170
SN22-290-290-610	290	290	610
SN22-290-370-690	290	370	690
SN22-290-450-770	290	450	770
SN22-290-530-850	290	530	850
SN22-290-610-930	290	610	930
SN22-290-690-1010	290	690	1010
SN22-290-850-1170	290	850	1170

SN28 SERIES

Order code	Slider	Stroke	Rail
SN28-60-30-130	60	30	130
SN28-60-110-210	60	110	210
SN28-60-190-290	60	190	290
SN28-60-270-370	60	270	370
SN28-60-350-450	60	350	450
SN28-80-90-210	80	90	210
SN28-80-170-290	80	170	290
SN28-80-250-370	80	250	370
SN28-80-330-450	80	330	450
SN28-80-410-530	80	410	530
SN28-80-490-610	80	490	610
SN28-130-120-290	130	120	290
SN28-130-200-370	130	200	370
SN28-130-280-450	130	280	450
SN28-130-360-530	130	360	530
SN28-130-440-610	130	440	610
SN28-130-520-690	130	520	690
SN28-130-600-770	130	600	770
SN28-130-680-850	130	680	850
SN28-130-760-930	130	760	930
SN28-130-840-1010	130	840	1010
SN28-210-200-450	210	200	450
SN28-210-280-530	210	280	530
SN28-210-360-610	210	360	610
SN28-210-440-690	210	440	690
SN28-210-520-770	210	520	770
SN28-210-600-850	210	600	850

Order Code	Slider	Stroke	Rail
SN28-210-680-930	210	680	930
SN28-210-760-1010	210	760	1010
SN28-210-920-1170	210	920	1170
SN28-210-1080-1330	210	1080	1330
SN28-290-280-610	290	280	610
SN28-290-360-690	290	360	690
SN28-290-440-770	290	440	770
SN28-290-520-850	290	520	850
SN28-290-600-930	290	600	930
SN28-290-680-1010	290	680	1010
SN28-290-840-1170	290	840	1170
SN28-290-1000-1330	290	1000	1330
SN28-290-1160-1490	290	1160	1490
SN28-370-360-770	370	360	770
SN28-370-440-850	370	440	850
SN28-370-520-930	370	520	930
SN28-370-600-1010	370	600	1010
SN28-370-760-1170	370	760	1170
SN28-370-920-1330	370	920	1330
SN28-370-1080-1490	370	1080	1490
SN28-450-440-930	450	440	930
SN28-450-520-1010	450	520	1010
SN28-450-680-1170	450	680	1170
SN28-450-840-1330	450	840	1330
SN28-450-1000-1490	450	1000	1490
SN28-450-1160-1650	450	1160	1650

SN35 SERIES

Order Code	Slider	Stroke	Rail
SN35-130-110-290	130	110	290
SN35-130-190-370	130	190	370
SN35-130-270-450	130	270	450
SN35-130-350-530	130	350	530
SN35-130-430-610	130	430	610
SN35-130-510-690	130	510	690
SN35-130-590-770	130	590	770
SN35-130-670-850	130	670	850
SN35-130-750-930	130	750	930
SN35-130-830-1010	130	830	1010
SN35-210-190-450	210	190	450
SN35-210-270-530	210	270	530
SN35-210-350-610	210	350	610
SN35-210-430-690	210	430	690
SN35-210-510-770	210	510	770
SN35-210-590-850	210	590	850
SN35-210-670-930	210	670	930
SN35-210-750-1010	210	750	1010
SN35-210-910-1170	210	910	1170
SN35-210-1070-1330	210	1070	1330
SN35-210-1230-1490	210	1230	1490
SN35-290-270-610	290	270	610
SN35-290-350-690	290	350	690
SN35-290-430-770	290	430	770
SN35-290-510-850	290	510	850
SN35-290-590-930	290	590	930
SN35-290-670-1010	290	670	1010
SN35-290-830-1170	290	830	1170

Order Code	Slider	Stroke	Rail
SN35-290-990-1330	290	990	1330
SN35-290-1150-1490	290	1150	1490
SN35-290-1310-1650	290	1310	1650
SN35-370-350-770	370	350	770
SN35-370-430-850	370	430	850
SN35-370-510-930	370	510	930
SN35-370-590-1010	370	590	1010
SN35-370-750-1170	370	750	1170
SN35-370-910-1330	370	910	1330
SN35-370-1070-1490	370	1070	1490
SN35-370-1230-1650	370	1230	1650
SN35-450-430-930	450	430	930
SN35-450-510-1010	450	510	1010
SN35-450-670-1170	450	670	1170
SN35-450-830-1330	450	830	1330
SN35-450-990-1490	450	990	1490
SN35-450-1150-1650	450	1150	1650
SN35-450-1310-1810	450	1310	1810
SN35-530-590-1170	530	590	1170
SN35-530-750-1330	530	750	1330
SN35-530-910-1490	530	910	1490
SN35-530-1070-1650	530	1070	1650
SN35-530-1230-1810	530	1230	1810
SN35-610-670-1330	610	670	1330
SN35-610-830-1490	610	830	1490
SN35-610-990-1650	610	990	1650
SN35-610-1150-1810	610	1150	1810

SN43 SERIES

Order Code	Slider	Stroke	Rail
SN43-130-110-290	130	110	290
SN43-130-190-370	130	190	370
SN43-130-270-450	130	270	450
SN43-130-350-530	130	350	530
SN43-130-430-610	130	430	610
SN43-130-510-690	130	510	690
SN43-130-590-770	130	590	770
SN43-130-670-850	130	670	850
SN43-130-750-930	130	750	930
SN43-130-830-1010	130	830	1010
SN43-210-190-450	210	190	450
SN43-210-270-530	210	270	530
SN43-210-350-610	210	350	610
SN43-210-430-690	210	430	690
SN43-210-510-770	210	510	770
SN43-210-590-850	210	590	850
SN43-210-670-930	210	670	930
SN43-210-750-1010	210	750	1010
SN43-210-910-1170	210	910	1170
SN43-210-1070-1330	210	1070	1330
SN43-210-1230-1490	210	1230	1490
SN43-210-1390-1650	210	1390	1650
SN43-290-270-610	290	270	610
SN43-290-350-690	290	350	690
SN43-290-430-770	290	430	770
SN43-290-510-850	290	510	850
SN43-290-590-930	290	590	930
SN43-290-670-1010	290	670	1010
SN43-290-830-1170	290	830	1170
SN43-290-990-1330	290	990	1330
SN43-290-1150-1490	290	1150	1490

Order Code	Slider	Stroke	Rail
SN43-290-1310-1650	290	1310	1650
SN43-290-1470-1810	290	1470	1810
SN43-370-350-770	370	350	770
SN43-370-430-850	370	430	850
SN43-370-510-930	370	510	930
SN43-370-590-1010	370	590	1010
SN43-370-750-1170	370	750	1170
SN43-370-910-1330	370	910	1330
SN43-370-1070-1490	370	1070	1490
SN43-370-1230-1650	370	1230	1650
SN43-370-1390-1810	370	1390	1810
SN43-450-430-930	450	430	930
SN43-450-510-1010	450	510	1010
SN43-450-670-1170	450	670	1170
SN43-450-830-1330	450	830	1330
SN43-450-990-1490	450	990	1490
SN43-450-1150-1650	450	1150	1650
SN43-450-1310-1810	450	1310	1810
SN43-450-1470-1970	450	1470	1970
SN43-530-590-1170	530	590	1170
SN43-530-750-1330	530	750	1330
SN43-530-910-1490	530	910	1490
SN43-530-1070-1650	530	1070	1650
SN43-530-1230-1810	530	1230	1810
SN43-530-1390-1970	530	1390	1970
SN43-610-670-1330	610	670	1330
SN43-610-830-1490	610	830	1490
SN43-610-990-1650	610	990	1650
SN43-610-1150-1810	610	1150	1810
SN43-610-1310-1970	610	1310	1970

SN63 SERIES

Order Code	Slider	Stroke	Rail
SN63-130-400-610	130	400	610
SN63-130-480-690	130	480	690
SN63-130-560-770	130	560	770
SN63-130-640-850	130	640	850
SN63-130-720-930	130	720	930
SN63-130-800-1010	130	800	1010
SN63-210-320-610	210	320	610
SN63-210-400-690	210	400	690
SN63-210-480-770	210	480	770
SN63-210-560-850	210	560	850
SN63-210-640-930	210	640	930
SN63-210-720-1010	210	720	1010
SN63-210-880-1170	210	880	1170
SN63-210-1040-1330	210	1040	1330
SN63-210-1200-1490	210	1200	1490
SN63-210-1360-1650	210	1360	1650
SN63-290-240-610	290	240	610
SN63-290-320-690	290	320	690
SN63-290-400-770	290	400	770
SN63-290-480-850	290	480	850
SN63-290-560-930	290	560	930
SN63-290-640-1010	290	640	1010
SN63-290-800-1170	290	800	1170
SN63-290-960-1330	290	960	1330
SN63-290-1120-1490	290	1120	1490
SN63-290-1280-1650	290	1280	1650
SN63-370-320-770	370	320	770

Order Code	Slider	Stroke	Rail
SN63-370-400-850	370	400	850
SN63-370-480-930	370	480	930
SN63-370-560-1010	370	560	1010
SN63-370-720-1170	370	720	1170
SN63-370-880-1330	370	880	1330
SN63-370-1040-1490	370	1040	1490
SN63-370-1200-1650	370	1200	1650
SN63-370-1360-1810	370	1360	1810
SN63-450-400-930	450	400	930
SN63-450-480-1010	450	480	1010
SN63-450-640-1170	450	640	1170
SN63-450-800-1330	450	800	1330
SN63-450-960-1490	450	960	1490
SN63-450-1120-1650	450	1120	1650
SN63-450-1280-1810	450	1280	1810
SN63-530-560-1170	530	560	1170
SN63-530-720-1330	530	720	1330
SN63-530-880-1490	530	880	1490
SN63-530-1040-1650	530	1040	1650
SN63-530-1200-1810	530	1200	1810
SN63-530-1360-1970	530	1360	1970
SN63-610-640-1330	610	640	1330
SN63-610-800-1490	610	800	1490
SN63-610-960-1650	610	960	1650
SN63-610-1120-1810	610	1120	1810
SN63-610-1280-1970	610	1280	1970

VERIFICATION UNDER STATIC LOAD

The load capacities of the **SN** series linear ball bearings are based on slider lengths and are shown on the tables on the previous pages. The loads and moments should be centered on the slider (for uncentered loads and moments, please see the paragraph at the bottom of this page). In the **SN** series the values of the loads and moments are independent from the slider position during the stroke.

By static verification, the radial load C_{0rad} , the axial load C_{0ax} and the moments M_x , M_y , M_z , give the maximum permissible value for the load, beyond which the rolling quality and the total mechanical strength may be compromised. Verification under static load has to be carried out by determining the necessary safety factor z which corresponds most closely to the actual loads and working conditions shown in the table below.

Neither shocks nor vibrations, smooth and low frequency reverse, high precision in assembly, no elastic yielding;	1 - 1.5
Normal assembly conditions;	1.5 - 2
Shocks and vibrations, significant elastic yield, high frequency reverse;	2 - 3.5

Verification must be made to ensure that the external load P or the external moment M are lower than or equal to the load capacities divided by the safety factor z :

$$\frac{P}{C_{0rad}} \leq \frac{1}{z} \quad \text{or} \quad \frac{P}{C_{0ax}} \leq \frac{1}{z} \quad \text{or} \quad \frac{M}{M_x (\text{or } M_y \text{ or } M_z)} \leq \frac{1}{z} \quad [1]$$

if P is only radial
if P is only axial
if only moments are present

where P is the external applied load, in newton and M is the external applied moment, in Nm. This is valid if the external load consists of a single force or a single moment. When forces and moments are present simultaneously, as frequently happens, verification must be made to ensure that the sum of each force or applied moment complies with the following formula:

$$\frac{P_{rad}}{C_{0rad}} + \frac{P_{ax}}{C_{0ax}} + \frac{M_1}{M_x} + \frac{M_2}{M_y} + \frac{M_3}{M_z} \leq \frac{1}{z} \quad [2]$$

P_{rad} , P_{ax} are the radial and axial resultants of the applied external loads, in newton;

M_1 , M_2 , M_3 are the resultant external moments, in Nm.

External load P in a non-central position on the slider:

If the load is not centered on the slider, the distribution of the different stresses on the balls and the consequent reduction in the load capacity C must be considered. As shown in the diagram at right, this reduction is dependent upon the distance d between the center of the slider and the point of application of the external load (where q is the coefficient of position and the distance d is expressed in fractions of the slider length S).

The external load P which can be applied as a function of d is:

$$P = q C_{0rad} \quad \text{if the external load } P \text{ is radial}$$

$$P = q C_{0ax} \quad \text{if the external load } P \text{ is axial}$$

For the verification under static load and the lifetime calculation (see page D13) in the formulas (1), (2), (3), P_{rad} and P_{ax} must be replaced by the corresponding equivalent values calculated as follows:

$$P_{rad} = \frac{P}{q} \quad \text{if the external load } P \text{ is radial}$$

$$P_{ax} = \frac{P}{q} \quad \text{if the external load } P \text{ is axial}$$

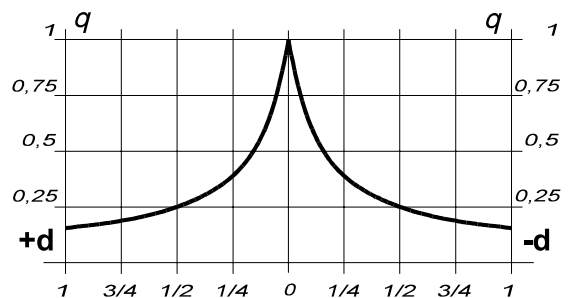
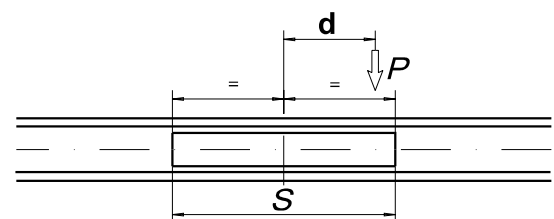

LIFETIME CALCULATION

The life of a linear ball bearing is influenced by many factors, such as applied load, working speed, precision in assembly, shocks and vibrations, operating temperature, working environment and lubrication. The definition of life is subject to interpretation: life is intended to mean the time elapsed between commencing operation and the appearance of the first signs of fatigue on the raceways of the bearings. In practice, however, it can better be defined as the functional failure of the ball bearing due to the destruction or excessive wear of one of its parts.

This can be taken into account by introducing a correction factor (f_i in the formula below).

The life may thus be calculated in compliance with the following relation:

$$L_{km} = 100 \cdot \left(\frac{C}{P_e} \cdot \frac{1}{f_i} \right)^3$$

where:

L_{km} is the calculated life, in km;

C is the dynamic load factor, in N, and is numerically equivalent to the load capacity C_{0rad} ;

P_e is the applied equivalent load, in N;

f_i is the service factor (see below table for values).

Neither shocks nor vibrations smooth and low-frequency reverse; clean working environment; low speed (< 0.5 m/s);	1 - 1.5
Light vibrations; medium speed (between 0.5 and 0.7 m/s) and medium reverse frequency;	1.5 - 2
Shocks and vibrations; high speed (> 0.7 m/s) and high reverse frequency; highly contaminated working environment;	2 - 3.5

When an external load P is equal to the radial load capacity C_{0rad} (which obviously can never be exceeded), the life in ideal conditions will be 100 km ($f_i=1$). With a single external load P , then obviously $P_e=P$.

If the external load consists of several forces or moments acting simultaneously, then the equivalent external load must be calculated according to the formula:

$$P_e = P_{rad} + \left(\frac{P_{ax}}{C_{0ax}} + \frac{M_1}{M_x} + \frac{M_2}{M_y} + \frac{M_3}{M_z} \right) \cdot C_{0rad} \quad [3]$$

CLEARANCE AND PRELOAD

The linear ball bearings of the **SN** series are normally assembled with **G1** clearance, this means that between the slider and the rail there is the lowest clearance which ensures maximum smoothness. For more information, please contact our engineering department.

FRICITION COEFFICIENT

When correctly lubricated, assembled on flat rigid structures, and parallel when used in pairs, the friction coefficient is equal to or less than 0.01. This value may vary in particular assembly situations (see "**Application Notes**" on the following page).

LINEAR PRECISION

With the rail fixed with all the screws to a theoretically flat structure and with the fixing holes on this structure in a straight line, the linear precision of the path followed by the slider with respect to a fixed external reference should comply with the following relation:

$$\boxed{||} = \frac{\sqrt{H}}{300} \text{ (mm)}$$

where H is the stroke of the slider in mm.

SPEED

Generally speaking, the linear ball bearings of the **SN** series can be used for speeds up to 0.8 m/s. For high movement frequencies, and therefore high accelerations during reversal of movement, it is advisable not to use bearings with particularly long ball cages, to reduce the risk of ball cage moving out of phase (see "**Application Notes**" on the following page).

APPLICATION NOTES

The **SN** series linear ball bearings have a ball cage mounted between the rail and the slider. During movement of the slider relative to the rail, the cage moves a distance equal to half the stroke of the slider. The stroke ends when the slider contacts the bent tabs situated at the ends of the ball cage.

The ball cage usually moves in function of the slider because of the rolling motion of the balls in the raceways. Sometimes however, instead of rolling, the balls slip, causing a loss of synchronism between cage and slider, resulting in premature contact of the ball cage with the end stops thus reducing the theoretical stroke.

The theoretical stroke can be restored by slipping the slider through the ball cage until there is simultaneous contact between the end stops of the track-rail, cage and slider. This procedure is known as re-phasing. There will be a strong resistance to sliding during the rephasing stage, resulting in a temporary increase in the load applied to the track-rail.

Ball cage slipping can be caused by inaccurate assembly, movement dynamics, load values and load variations.

To reduce to a minimum the inconvenience caused by an out of phase ball cage, the recommendations given below should be followed.

The stroke should be constant for the entire working cycle and should preferably be as close as possible to the nominal stroke of the linear bearing. For applications using variable strokes, it is important to accept the possibility of rephasing the ball cage, and ensuring that there is sufficient drive capacity to allow for an occasional increase in traction, amounting to an increase in the coefficient of friction till about 0.1.

An alternative solution, already adopted by several customers, consists of periodically inserting into the working cycle a movement without load, and equal to the maximum stroke allowed by the bearing. This either prevents the ball cage from moving out of phase or rephases it automatically.

In cases where a pair of parallel linear bearings is used, any errors in parallelism or planarity of the contact surfaces during assembly will intensify phase displacement and consequent rephasing activity. If at the planning or design stage, it is anticipated that rephasing problems will occur, it is advisable to specify "**linear ball bearings with increased clearance**".

SN products can be used for horizontal movements only.

When using linear ball bearings in the **SN** series with multiple independent or synchronised sliders, if there is any uncertainty regarding the precision of the fixing surfaces for the track-rails and sliders, it's strongly recommended to use **linear bearings with increased clearance**.

For any further information, please contact our engineering department.

TEMPERATURE

SN products can be used in environments with temperatures of up to +170°C (+338 °F) (over 130°C [266°F] it is necessary to use a high temperature grease). For use at higher temperatures, contact our engineering department.

ANTICORROSIVE PROTECTION

All the elements (slider, ball cage and rail) are protected against corrosion by **electrolytic zinc plating** in compliance with ISO 2081 standards.

Upon request, other surface treatments can be done.

For any further information, please contact our engineering department.

LUBRICATION

This is largely dependent upon the working environment. Under normal conditions, lubrication should be scheduled for every **100 km** of slider travel, using a good quality lithium-soap grease of medium consistency and of the type normally used for rolling element bearings.