

Koyo[®]

LONG LIFE BEARING SERIES



KOYO SEIKO CO., LTD.

CAT.NO.199E

1. Extension of Bearing Life

1.1 Mechanism of Flaking

Type			
	SURFACE STARTING FLAKING		INSIDE STARTING FLAKING
	SURFACE FLAKING	BRINELLING INITIATED FLAKING	
Mechanism			
Long Life Bearings	SH,KE,MF		HRS,GTS,KUJ 7,CH 213

1.2 Koyo Long Life Bearing Series

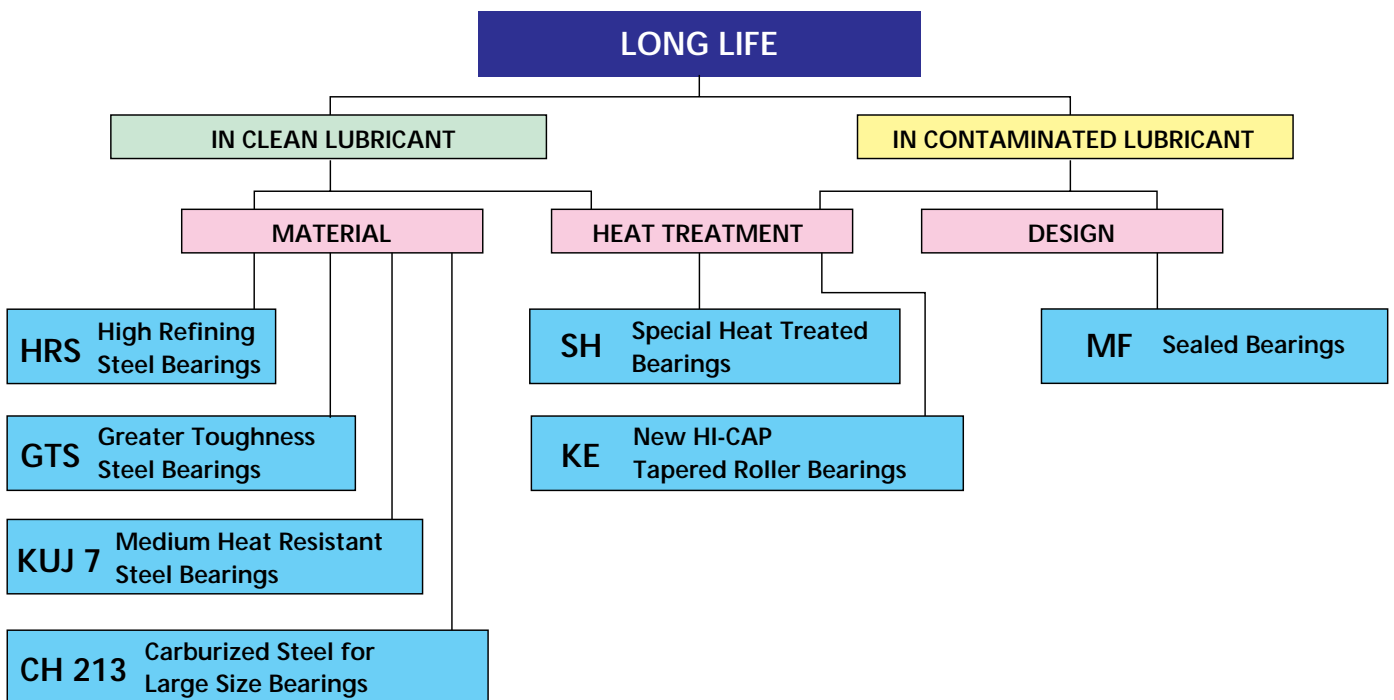

2. Bearing Life Evaluation Results Against Flaking

HRS

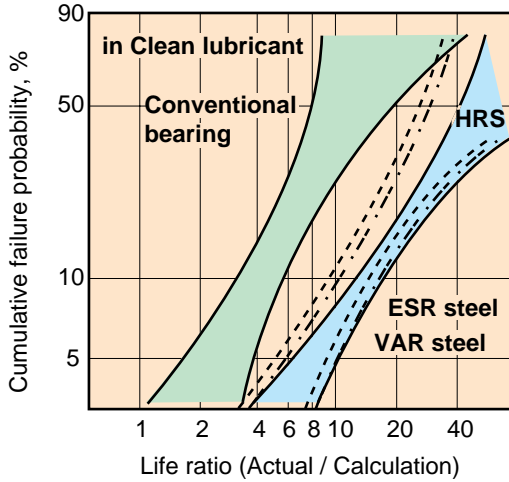

GTS

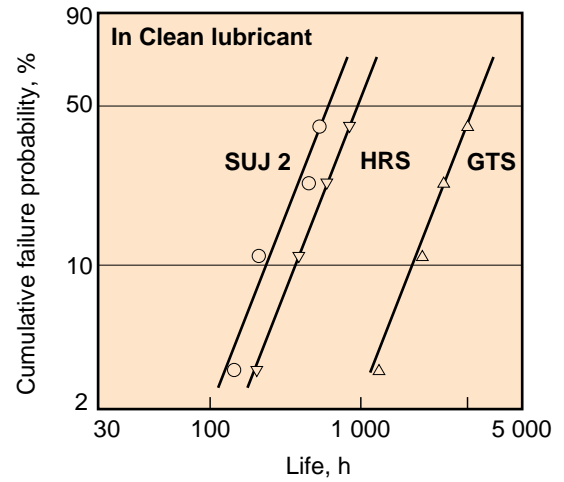

KUJ 7

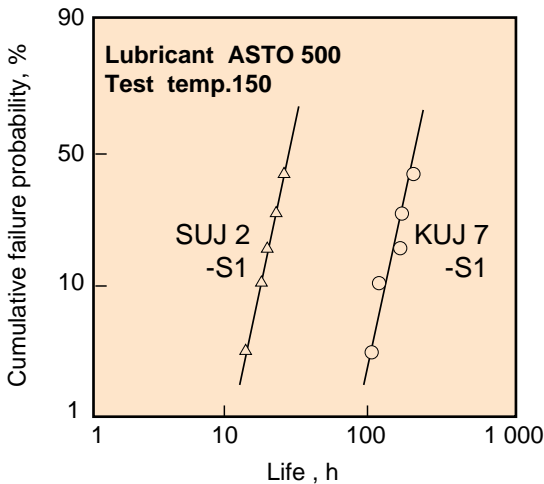

CH 213

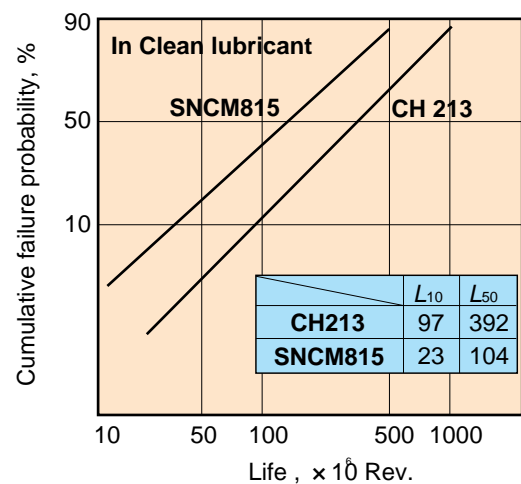

SH and KE

Life in contaminated lubricant

SH bearing, KE bearing
:10 times or longer

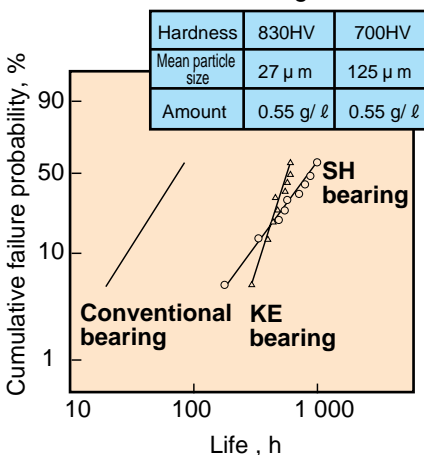

Life in clean lubricant

SH bearing: 6 times or longer
KE bearing: 2 times or longer

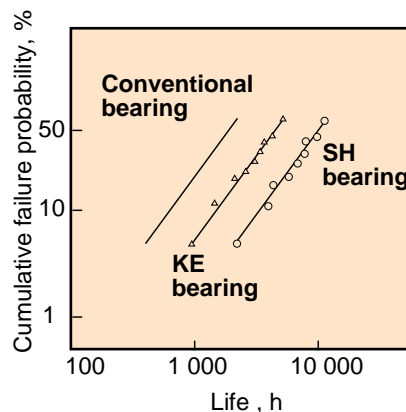

Dent resistance

SH bearing: 8 times or more
KE bearing: 10 times or more

Dent area ratio measured at 20 points of inner ring raceway center and analyzed by computer

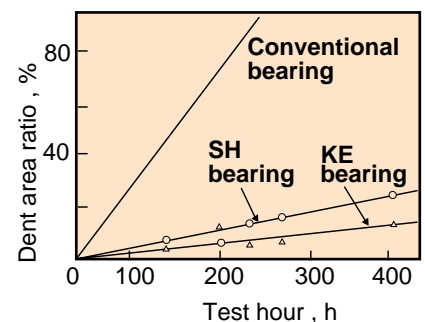

3. Bearing Types and Performance

LONG LIFE BEARINGS	MATERIAL	CHARACTERISTICS AND EFFECTS	PERFORMANCE (Compared with Conventional Bearings)		APPLICABLE BEARINGS					APPLICATIONS
			Life in clean lubricant	Life in contaminated lubricant	Ball Brg.	Cylindrical Roller Brg.	Tapered Roller Brg.	Spherical Roller Brg.	Needle Roller Brg.	
HRS (High Refining Steel Bearings)	Through Hardened Steel (SUJ2)	<ul style="list-style-type: none"> Equivalent to special remelting steel Long life by minimizing inclusions HRS with SH treatment is more better 	3 times or longer	Same	●	●	●	●		<ul style="list-style-type: none"> For Automobile
GTS (Greater Toughness Steel Bearings)	Through Hardened Steel	<ul style="list-style-type: none"> Significant toughness and matrix strength by controlling alloy element 	6 times or longer	2 times or longer	●	●	●	●		<ul style="list-style-type: none"> Extra long life under heavy load
KUJ 7 (Medium Heat Resistant Steel Bearings)		<ul style="list-style-type: none"> High resistance against hardness reduction by tempering 	7 times or longer (at 150 °C)	2 times or longer	●	●	●	●		<ul style="list-style-type: none"> For Continuously casting equipment For Turbocharger
CH 213 (Carburized Steel for Large Size Bearings)	Carburized Steel	<ul style="list-style-type: none"> High resistance against hardness reduction by tempering Controlled alloy element 	4 times or longer	2 times or longer		●	●			<ul style="list-style-type: none"> For Steel rolling mill
SH (Special Heat Treated Bearings)	Through Hardened Steel	<ul style="list-style-type: none"> High surface hardness Adequate resistance to wear 	6 times or longer	10 times or longer	●	●	●		●	<ul style="list-style-type: none"> In contaminated lubricant such as differential and transmission
KE (New HI-CAP Tapered Roller Bearings)	Carburized Steel	<ul style="list-style-type: none"> High surface hardness Controlled retained austenite 	2 times or longer	10 times or longer			●			

Applications

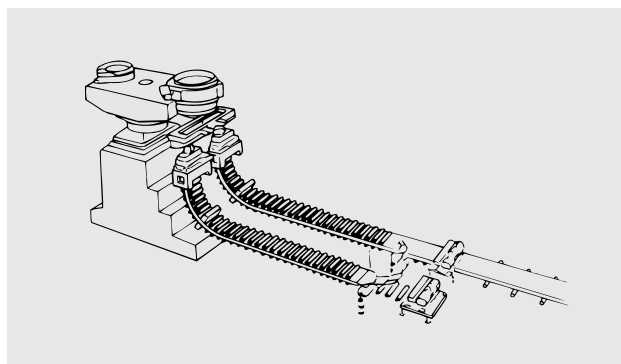

Continuously casting equipment



Steel rolling mill



Turbocharger

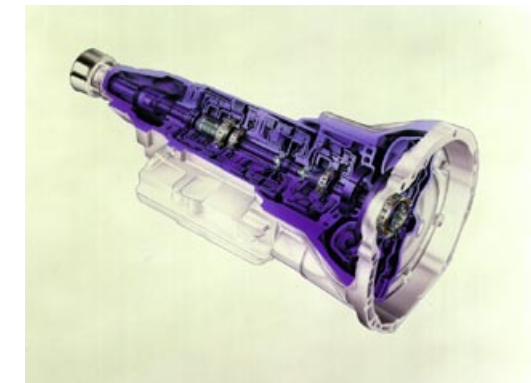

Transmission

4. Life Comparison

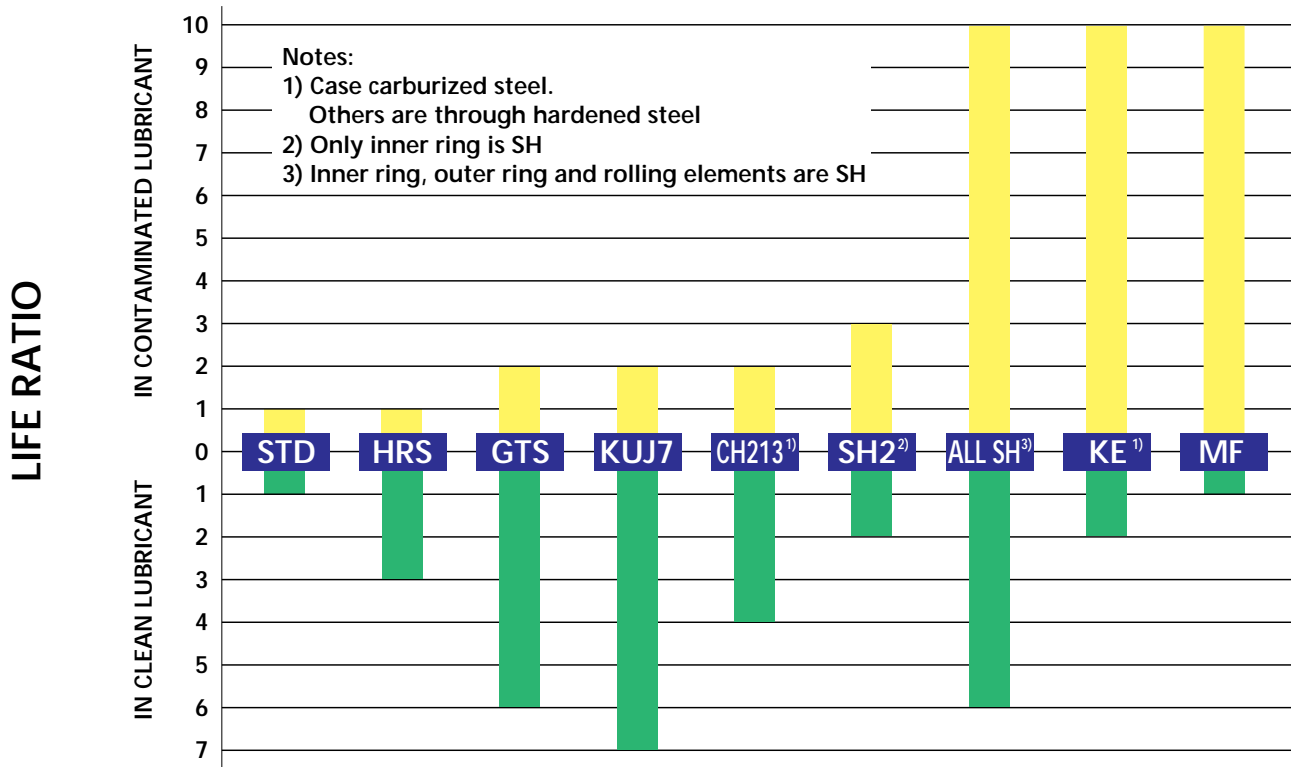

INTERNATIONAL NETWORK

KOYO SEIKO CO.,LTD. HEAD OFFICE
 TEL: 81-6-245-6087 FAX: 81-6-244-0814

KOYO CANADA INC.
 TEL: 1-905-681-1121 FAX: 1-905-681-1392

** KOYO CORPORATION OF U.S.A.
 TEL: 1-216-835-1000 FAX: 1-216-835-9347

** KOYO CORPORATION OF U.S.A.
 (AUTO SALES & TECHNICAL CENTER)
 TEL: 1-313-454-1500 FAX: 1-313-454-4076

KOYO DE MEXICO, S.A.
 TEL: 52-5-358-0214, 0077 FAX: 52-5-576-8827

KOYO LATIN AMERICA, S.A.
 TEL: 507-264-0977 FAX: 507-264-2782, 269-7578

KOYO ROLAMENTOS DO BRASIL LTDA.
 TEL: 55-11-288-3515 FAX: 55-11-288-3237

THAI KOYO CO.,LTD.
 TEL: 66-2-264-0395, 66-2-661-9603-5 FAX: 66-2-661-9606

KOYO SINGAPORE BEARING (PTE.) LTD.
 TEL: 65-274-2200 FAX: 65-274-1164

PHILIPPINE KOYO BEARING CORPORATION
 TEL: 63-2-817-8901,8881 FAX: 63-2-867-3148

KOYO SEIKO CO.,LTD. SEOUL BRANCH
 TEL: 82-2-549-7922 FAX: 82-2-549-7923

KOYO SEIKO CO.,LTD. BEIJING LIAISON OFFICE
 TEL: 86-10-6512-5673,9401 FAX: 86-10-6512-5674

KOYO AUSTRALIA PTY. LTD.
 TEL: 61-2-9638-2355 FAX: 61-2-9638-3368

KOYO SEIKO CO.,LTD. EUROPEAN CENTRAL OFFICE
 TEL: 31-36-5383333 FAX: 31-36-5347212

KOYO KULLAGER SCANDINAVIA A.B.
 TEL: 46-8-590-341-85 FAX: 46-3-590-309-69

* KOYO (U.K.) LIMITED
 TEL: 44-1908-664422 FAX: 44-1908-607971

EUROPA-KOYO B.V.
 TEL: 31-184-606800 FAX: 31-184-602572

KOYO DEUTSCHLAND GMBH.
 TEL: 49-40-67-9090-0 FAX: 49-40-67-9203-0

KOYO FRANCE S.A.
 TEL: 33-1-3998-4222 FAX: 33-1-3998-4244

KOYO ESPANOLA, S.A.
 TEL: 34-1-329-0818 FAX: 34-1-747-1194

KOYO ITALIA S.R.L.
 TEL: 39-2-2951-0844 FAX: 39-2-2951-0954

KOYO SEIKO CO.,LTD.(Japan) is certified to ISO9001.
 *: ISO9002 certified. **: ISO9001 certified.



ISO 9001
 Certificate No. 927265

VALUE & TECHNOLOGY